

JVC

CAMCORDER

Detailed User Guide

GZ-GX1

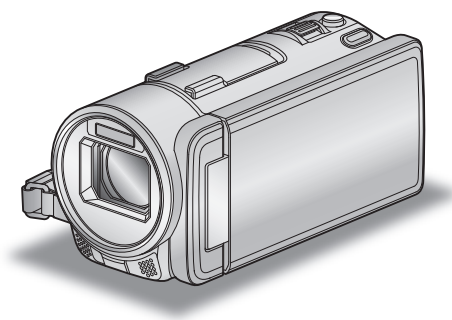

Table of Contents

Beginner's Guide	5
Charging	5
Recording	5
Playback	5
Shooting Tips	5
Holiday Season/Christmas	6
Wedding	7
Travel	8
Amusement Park	10

Using Wi-Fi

Wi-Fi Capabilities	12
Operating Environment	13
Precautions on Using Wi-Fi	13
Image Monitoring via Direct Connection (DIRECT MONITORING)	14
Recording the Location Information	17
Image Monitoring via an Access Point at Home (OUTSIDE MONITORING)	18
Image Monitoring via the Internet (OUTSIDE MONITORING)	20
Send Still Images via E-mail upon Detection of Face or Movement (DETECT/MAIL SETTING)	24
Record and Send Videos via E-mail (VIDEO MAIL ATTN.) ...	25
Changing the Settings	27
Setting the Password (OUT MONITORING SET)	29
Setting the UPnP of this Camera (OUT MONITORING SET)	29
Obtaining a Dynamic DNS (DDNS) Account	30
Setting Dynamic DNS (DDNS) on this Camera (OUT MONITORING SET)	30
Setting the Sender's E-mail Address	31
Registering the Recipient's E-mail Address	34
Setting the Detection Method of this Camera (DETECT/MAIL SETTING)	35
Setting the Detection Interval of this Camera (DETECT/MAIL SETTING)	35
Setting Self Recording on this Camera (DETECT/MAIL SETTING)	36
Registering the Access Points to Connect ("ACCESS POINTS")	36
Setting the Password (DIRECT MONITORING)	41
Setting the Enforced Group Owner (DIRECT MONITORING)	42
Checking the MAC Address of this Camera	42
Protecting the Network Settings with a Password	43
Initializing the Network Settings	43
Using Smartphone Applications	44
Indications on the Screen	44
Transferring Videos	45
Transferring Still Images	46
Changing the Settings	48
Using the Wi-Fi Function from a Web Browser	50
Indications on the Screen	50
Making Camera Settings from a Web Browser	52
Troubleshooting	57
Wi-Fi Specifications	60

Getting Started

Verifying the Accessories	62
Charging the Battery Pack	64
Grip Adjustment	65
Inserting an SD Card	65
Types of Usable SD Card	66
Using the Touch Screen	67
Names of Buttons and Functions on the LCD Monitor	67
Clock Setting	69
Resetting the Clock	69

Changing the Display Language	70
Holding this Unit	71
Tripod Mounting	71
Using the Remote Control	71
Attaching Headphones	72
Attaching an External Microphone	73
Using this Unit Overseas	73
Charging the Battery Pack Overseas	73
Setting the Clock to Local Time when Traveling	74
Setting Daylight Saving Time	74
Optional Accessories	75

Recording

Taking Videos in Auto Mode	76
Zooming	79
Capturing Still Images During Video Recording	79
Taking Still Images in Auto Mode	79
Zooming	81
Manual Recording	82
Shooting According to Scene (Subject)	84
Adjusting Focus Manually	86
Adjusting Brightness	87
Setting Shutter Speed	88
Setting Aperture	89
Setting White Balance	90
Setting Backlight Compensation	91
Checking for Overexposed Areas (ZEBRA)	92
Taking Close-up Shots	93
Recording with Effects	94
Recording with Animation Effects	94
Recording with Face Decorations	96
Recording with Decorative Stamps	96
Recording with Personal Handwriting	97
Capturing Subjects Clearly (TOUCH PRIORITY AE/AF)	99
Capturing Smiles Automatically (SMILE SHOT)	100
Capturing Pets Automatically (PET SHOT)	102
Recording while Displaying a Magnified View of a Selected Face (FACE SUB-WINDOW)	103
Registering Human Face Personal Authentication Information	105
Setting SMILE%/NAME DISPLAY	107
Editing the Registered Face Information	108
Reducing Camera Shake	110
Slow-motion (High-speed) Recording	110
Recording at Intervals (TIME-LAPSE RECORDING)	111
Recording Automatically by Sensing Movements (AUTO REC)	113
Taking Group Shots (Self-timer)	114
Recording Videos with Date and Time	116
Checking the Remaining Recording Time	117

Playback

Playing Back Videos	119
Checking the Recording Date and Other Information	121
Checking the Content of Videos Quickly (Digest Playback)	121
Playing a Video with Defective Management Information	122
Playing Back Still Images	123
Slideshow Playback	124
Searching for a Specific Video/Still Image by Date	125
Connecting to and Viewing on TV	125
Connecting via the HDMI Mini Connector	126
Connecting via the AV Connector	127
Playing Back Playlists	127
Playing Back a DVD or Blu-ray Disc Created on this Unit	128
Digest Playback on a Blu-ray or DVD Player	128

Editing

Deleting Unwanted Files	129
Deleting the Currently Displayed File	129

Deleting Selected Files	129
Protecting Files	130
Protecting/Releasing Protection of the Currently Displayed File	130
Protecting/Releasing Protection of Selected Files	131
Capturing a Still Image in the Video During Playback	132
Capturing a Required Part in the Video (TRIMMING)	132
Capturing Videos for Uploading to YouTube	133
Creating Playlists from the Recorded Videos	135
Creating Playlists with Selected Files	135
Creating Playlists by Date	136
Editing Playlists	137
Deleting Playlists	138

Copying

Creating Discs with a DVD Writer	139
Preparing a DVD Writer (CU-VD3)	140
Preparing a DVD Writer (CU-VD50)	140
Creating a Disc	141
Playing Back with a DVD Writer	145
Creating Discs with a BD Writer (External Blu-ray Drive)	146
Preparing a BD Writer (External Blu-ray Drive)	146
Creating a Disc	147
Playing Back with a BD Writer (External Blu-ray Drive)	153
Creating a Disc Using a Connected Blu-ray Recorder	154
Dubbing Files to a Disc by Connecting to a DVD Recorder	154
Dubbing Files to a VHS Tape by Connecting to a VCR	155
Using a USB External Hard Disk Drive	155
Preparing a USB External Hard Disk Drive	156
Copying All Files	156
Playing Back Files in the USB External Hard Disk Drive	157
Deleting Folders in the USB External Hard Disk Drive	158
Formatting the USB External Hard Disk Drive	158
Importing Files from the USB External Hard Disk Drive	159
Copying to Windows PC	160
Verifying System Requirements (Guideline)	160
Installing the Provided Software	161
Backing Up All Files	162
Organizing Files	163
Recording Videos to Discs	164
Backing Up Files Without Using Provided Software	166
List of Files and Folders	167
Copying to Mac Computer	168

Menu Settings

Operating the Menu	169
Operating the Shortcut Menu	169
Operating the Main Menu	170
Operating the Common Menu	170
Recording Menu (Video)	171
INFO	174
SCENE SELECT	174
FOCUS	174
BRIGHTNESS ADJUST	174
SHUTTER SPEED	174
APERTURE PRIORITY	174
WHITE BALANCE	174
BACKLIGHT COMP.	174
ZEBRA	174
TELE MACRO	174
TOUCH PRIORITY AE/AF	174
LIGHT	175
GAIN UP	175
WIND CUT	176
GRID	176
ANIMATION EFFECT	177
DECORATE FACE EFFECT	177
STAMP	177
HANDWRITING EFFECT	177
HIGH SPEED RECORDING	177
TIME-LAPSE RECORDING	177

AUTO REC	177
Wi-Fi	177
DATE/TIME RECORDING	177
FACE SUB-WINDOW	177
SHUTTER MODE	177
CONT. SHOOTING SPEED	178
SMILE SHOT	178
SMILE%/NAME DISPLAY	178
FACE REGISTRATION	178
PET SHOT	178
SYSTEM SELECT	179
VIDEO QUALITY	179
ZOOM	180
x.v.Color	180
ZOOM MIC	181
MIC LEVEL	181
MIC LEVEL SETTING	182
HEADPHONE VOL. ADJ.	182
Recording Menu (Still Image)	184
INFO	186
SCENE SELECT	186
FOCUS	186
BRIGHTNESS ADJUST	186
SHUTTER SPEED	186
APERTURE PRIORITY	186
WHITE BALANCE	186
BACKLIGHT COMP.	186
TELE MACRO	186
TOUCH PRIORITY AE/AF	186
FLASH	186
SELF-TIMER	187
GAIN	187
AUTO REC	188
SHUTTER MODE	188
CONT. SHOOTING SPEED	189
SMILE SHOT	189
SMILE%/NAME DISPLAY	189
FACE REGISTRATION	189
PET SHOT	189
IMAGE SIZE	190
GRID	190
Playback Menu (Video)	191
FILE INFORMATION	192
SEARCH DATE	192
DISPLAY DATE/TIME	192
DIGEST PLAYBACK	193
PLAYBACK PLAYLIST	193
EDIT PLAYLIST	193
PROTECT/CANCEL	193
TRIMMING	193
UPLOAD SETTINGS	193
PLAYBACK OTHER FILE	193
K2 TECHNOLOGY	193
Playback Menu (Still Image)	194
FILE INFORMATION	194
SEARCH DATE	194
SLIDE SHOW EFFECTS	195
PROTECT/CANCEL	195
Common Menu	196
CLOCK ADJUST	198
DATE DISPLAY STYLE	198
LANGUAGE	198
MONITOR BRIGHTNESS	198
OPERATION SOUND	199
SILENT MODE	199
AUTO POWER OFF	200
QUICK RESTART	200
REMOTE	201
DEMO MODE	201
TOUCH SCREEN ADJUST	202
DISPLAY ON TV	203
VIDEO OUTPUT	203

HDMI OUTPUT	204
HDMI CONTROL	204
FACTORY PRESET	205
UPDATE	205
FORMAT SD CARD	205
OPEN SOURCE LICENSES	205
MOBILE USER GUIDE	206

Names of Parts

Front	207
Rear	207
Bottom	208
Interior	208
LCD Monitor	209

Indications on the LCD monitor

Common Recording Indications	210
Video Recording	210
Still Image Recording	211
Video Playback	211
Still Image Playback	212

Troubleshooting

When the unit is not working properly	212
Battery Pack	213
Recording	213
Card	214
Playback	214
Editing/Copying	215
Computer	216
Screen/Image	216
Other Problems	217
Error Message?	217

Maintenance

Specifications

Charging

- Refer to the operating instructions found in the animation on the Detailed User Guide.

Recording

- Refer to the operating instructions found in the animation on the Detailed User Guide.

Playback

- Refer to the operating instructions found in the animation on the Detailed User Guide.

Shooting Tips

Basic Way to Hold a Camcorder ~ Recording Stable Images ~



This is the standard way of shooting while standing up. Be sure to master this basic technique in order to achieve stable images.

■ [Getting Ready]

- 1 Open your feet to the width of your shoulders.
- 2 Keep the elbow of your right arm, which is holding the camcorder, close to your side.
- 3 Hold the LCD monitor with your left hand and adjust the angle accordingly.

Extending Your Hands to Shoot ~ High-Angle Shooting ~



Extend your hand when your subject is being hidden behind a crowd of people.

■ [Getting Ready]

- 1 Open your feet to the width of your shoulders.
- 2 Extend your right hand and hold the camcorder over your head.
- 3 Hold the LCD monitor with your left hand and adjust the angle accordingly.

Caution :

- Use this way of shooting only as a last resort as it is difficult to achieve stable images.
- Set to the wide angle as much as possible as the image will be prone to camera shake.
- Be considerate. Do not inconvenience the people around you.

Squatting and Shooting at Eye Level



Staying low is a common position to take when shooting small children. By recording from the eye level of the child, you can capture all his cute expressions clearly.

■ [Getting Ready]

- 1 Kneel down with your left knee while keeping your right foot on the ground.
- 2 Place the elbow of your right arm, which is holding the camcorder, on your right knee.
- 3 Hold the LCD monitor with your left hand and adjust the angle accordingly.

Panning

- Refer to the operating instructions found in the animation on the Detailed User Guide.

Use this method to shoot a wide angle of view.

■ [Getting Ready]

- 1 Shoot by rotating your body instead of moving your arms while keeping the basic way of holding a camcorder as stated above.
- 2 Stand facing the direction where the rotation will stop.
- 3 Twist your upper body to the direction where recording will start.
- 4 Press the start button and record for 2 seconds, then slowly twist back your body to face the front.
Record for another 2 seconds while facing the front, then press the stop button.
(The 90 degrees rotation should take about 5 seconds, giving the feeling of a slow motion.)

Holiday Season/Christmas

Record the happy Christmas celebration with your family!



Photo by 101st CAB, Wings of Destiny
[Creative Commons Attribution-No Derivative Works 3.0](#)

Decorating the Tree and Preparing the Dinner

The decoration of tree and preparation of dinner are part of the joy of Christmas. Be sure to record these happy family times!

■ Decorating the tree



A tree is the most important thing to bring out the mood of Christmas. Simply the scene of all family members engaging in the decorating of a fir tree with various colorful ornaments is full of the feeling of happiness.

■ Preparing the Dinner



Photo by Manicosity
[Creative Commons Attribution-No Derivative Works 3.0](#)
Record the scenes as everyone helps to prepare the feast of the night. You can film the mother who is cooking, the children who are helping, and of course, the process of making a cake!

Recording the Christmas Party



Photo by InnerSpirit
[Creative Commons Attribution-No Derivative Works 3.0](#)

After all preparations, it is finally the Christmas party itself. Not only should you record the candle-blowing scene, but also the smiles of the family while being surrounded by good food, or even the father who is slightly drunk from champagne!

Finding the Presents



For children, the greatest joy of Christmas is receiving presents the next morning. Their expression of delight when finding a present next to their pillow is a recording opportunity not to be missed. Get ready to shoot before the children wake up!

Wedding

Create an awesome wedding video for the bride and groom!



Discussing and Planning Before the Event

Before the day of the wedding reception, it is important to discuss with the bride and groom about various details such as the order of the ceremony and whether there are any entertainment programs or change of clothes. By understanding the preferences of the bride and groom, you will be able to shoot more appropriately.

■ Finding out the route of entrance



The highlight of a wedding reception is the entrance of the bride and groom. Find out which door they will enter from and the route they will take from the person-in-charge of the wedding hall in advance. Set up the tripod at a place where you can follow the couple using zoom without having to move around.

■ Number of times and timing of clothes-changing

Find out the timing of any changing of clothes so as to capture the scene well when the bride and groom enter again. You can also make use of the time while the bride and groom are changing to record comments of well wishes from the guests.

Finding the Right Angle to Capture Both Bride and Groom

■ Composing the picture with the groom in front and the guests at the back



The main characters of a wedding are of course the bride and groom. Record their expressions clearly during the toast, speech, entertainment programs, and other scenes.

Another recommendation is to capture the face shots of the guests, then pan towards the groom. Picture composition containing the crowd of guests only lacks fun, so be sure to pay attention to the shooting angle and size.

Recording the Expressions and Comments of Guests

■ Setting the shot from eye level to chest level



You can record comments from the guest by going around asking, "Please say a few words for the bride and groom".

This can be done at the guests' waiting room, when the bride and groom are changing, or during the entertainment programs.

Advanced Operation with Two Camcorders

If video-editing is to be done, record using two camcorders so that a video with varying scenes can be created. You can try asking a close friend who has a camcorder at home.

Set the borrowed camcorder on a tripod to focus on taking close-up shots of the bride and groom. In this way, the other camcorder can be moved around to record other scenes, enabling an interesting video with changing scenes to be created through editing and compilation.

As most people own at least a digital camera nowadays, even if you are really unable to find an extra camcorder, inserting still pictures to the video at various points is also a good way to add variety. Do give it a try!

■ <Camcorder 1>

Closing up on the bride and groom all the time



■ <Camcorder 2>

Recording the congratulatory messages from friends at the same time



Travel

Capture all the good times of your domestic or overseas trips!



Bringing the Necessary Equipment

The necessary things to bring on a trip depends on your traveling purpose and the destination.

For overseas trips in particular, you have to think about what to bring in accordance to the local conditions.

Here are some suggestions for your consideration.

■ Camcorder

Think about how many hours of shooting you will usually perform in a day. Be sure to prepare enough recording medium especially for long overseas trips.

If you are recording in SD cards, get ready the sufficient number of cards, including some for backup.

■ Battery Pack

Prepare a battery pack that is ready for three times the expected recording time in a day. For example, if you plan to record for 2 hours a day, prepare a battery pack that is ready for 6 hours (actual recording time).

For a day trip, you can prepare a battery with low capacity but for a long trip, do prepare a few batteries with high capacities.

■ AC Adapter

The JVC AC adapter supports voltages from 110 V to 240 V, and hence can be used anywhere in the world.

Bring along the adapter if you are traveling for a long time. Charge the battery pack while sleeping so that you can record with full battery power the next day.

■ Power Plug Adapter



The shape of the power plug varies according to countries. Be sure to check the shape of the power plug beforehand, and bring the appropriate power plug adapter.

“Charging the Battery Pack Overseas” (☞ p. 73)

■ Battery Charger



Recording cannot be performed when an AC adapter is connected to the camcorder for battery charging. You can bring an additional battery charger to charge battery packs if you plan to use the camcorder for recording at night. You can also charge multiple battery packs by using both the battery charger and this camcorder at the same time.

■ Tripod



A tripod is an essential item to take stable images. Select an appropriate tripod in accordance to your purpose and style of traveling, such as a compact one to be used on a table or one that is at least 1 m tall.

Recording the Excitement Before Departure

It may be a little abrupt to start your travel video at the destination suddenly. Record also the preparations prior to departure if it is a family trip, or the time when everyone is gathered at the meeting place if you are traveling with your friends.

For overseas trips, taking a shot of the signs and displays at the airport of the flight you are taking may be useful for future reference.



Using Pan at the Places of Interest

Tourists spots with beautiful scenery or historical sites are places that you would certainly want to record.

To capture the magnificence of a scene which cannot be fitted into a single frame, try the panning technique.

Refer to "Shooting Tips" found in the "Beginner's Guide" on this website on how to use panning effectively.

In addition, you may also like to take a shot of the signs or monuments that can often be found at the tourist spots.



Showing Everyone Having a Good Time

When taking a video, it is rather dull to shoot only the scenery or historical sites.

Talk about your feelings while recording the breath-taking scenery of an attraction so that it will be an interesting scene to view later.

Amusement Park

Take more shots of the smiling faces of everyone in the family!



Taking Videos or Still Images According to the Attraction

You may choose to take videos all the time. However, you may want to take some still images too.

The following section explains the scenarios suitable for taking videos or still images.

■ Scenarios suitable for taking videos



Scenarios with changes in body movement are suitable for taking videos. This includes situations where there are rapid changes in facial expressions or voices of surprise and delight.

*Some amusement parks do not allow passengers to perform any recording. Be sure to check beforehand.

[Examples]

- Merry-go-round, go kart, coffee cup, etc.

■ Scenarios suitable for taking still images (photos)



Scenarios with little movement of the subject are suitable for taking still images.

Try to take the still images from an angle such that the surroundings can be seen clearly.

[Examples]

- Carousal, ferris wheel, fun bicycle rides, etc.

Inducing Responses by Calling Out



Videos with no waving of hands nor laughter are not only dull when you view them later, but also put the capability of the audio-recording function of the camcorder to a waste.

When recording, induce more reactions by enthusiastically waving your hands or shouting out "Is it fun?" and the like.

Capturing the Best Moment in a Video as a Still Image

Shots with the eyes closed are often taken by accident. To reduce such mistakes, make use of the function to capture still images from videos.

As videos are actually continuous recording of 60 still images within 1 minute, using this function allows you to select the best moment and save it as a still image.

"Capturing a Still Image in the Video During Playback" (p. 132)



Photo by just that good guy jim

[Creative Commons Attribution-No Derivative Works 3.0](#)

Video Playback in Progress



[Creative Commons Attribution-No Derivative Works 3.0](#)



Photo by just that good guy jim

[Creative Commons Attribution-No Derivative Works 3.0](#)

Video Playback in Progress

Advanced Operation with Backlight Compensation

When the subject's face is in backlight or when the expression cannot be seen clearly, the Intelligent Auto function of this unit automatically increases its brightness for recording.

If Intelligent Auto fails to function as expected or if the brightness correction is insufficient, you can increase the brightness by using backlight compensation in the Manual mode.

"Setting Details" (☰ p. 91)

■ <Without backlight compensation>



■ <With backlight compensation>



Wi-Fi Capabilities

This unit is equipped with Wi-Fi function.

You can do the following using a smartphone or computer via wireless connection.

Name of Function	Capability
Direct Monitoring	<ul style="list-style-type: none"> You can check the image on the camera via direct 1-to-1 connection (Wi-Fi Direct) with a smartphone (or computer), without the need for an access point (wireless LAN router). Recording of videos and still images may be performed while monitoring. “Image Monitoring via Direct Connection (DIRECT MONITORING)” (p. 14)
GPS Recording	<ul style="list-style-type: none"> You can record the location information of the venue where recording is taking place via direct connection (Wi-Fi Direct) with a smartphone. The recorded location information can be used on the Everio MediaBrowser 4 software provided with this unit. “Recording the Location Information” (p. 17)
Outside Monitoring	<ul style="list-style-type: none"> You can check the image on the camera with a smartphone (or computer) via an access point at home using wireless LAN router. Recording of videos and still images may be performed while monitoring. “Image Monitoring via an Access Point at Home (OUTSIDE MONITORING)” (p. 18) <ul style="list-style-type: none"> You can check the image on the camera via internet connection with a smartphone (or computer) while you are outside. Recording of videos and still images may be performed while monitoring. “Image Monitoring via the Internet (OUTSIDE MONITORING)” (p. 20)
Notification Mail	<ul style="list-style-type: none"> A still image is automatically captured and sent via e-mail when faces or movements are detected by the camera. You can also set to record videos on the camera during detection. “Send Still Images via E-mail upon Detection of Face or Movement (DETECT/MAIL SETTING)” (p. 24)
Video Mail	<ul style="list-style-type: none"> Videos of up to 15 seconds can be recorded and sent via e-mail. “Record and Send Videos via E-mail (VIDEO MAIL ATTN.)” (p. 25)
VIDEO TRANSFER·STILL IMAGE TRANSFER	<ul style="list-style-type: none"> You can transfer recorded videos or still images using smartphone applications (or computer browsers).

Terms Used in this Guide:

- In this guide, operations on the touch panel are described as “tap”.
- While the names of the buttons on a smartphone are written as “MENU” or “RETURN”, they may vary according to the smartphone in use.

Refer also to the instruction manual of your smartphone.

Operating Environment

To use the smartphone application “Everio sync.”, it is necessary to meet the following requirements.

Android Smartphone

- 1 OS: Android2.1 or higher

(This unit is not guaranteed to operate with all models.)

- 2 Supports GPS function (for GPS recording)
- 3 Able to connect to the internet or “Android Market™” (required for software installation)

iPhone/iPad/iPod touch

- 1 OS: iOS4.3.5 or higher

(This unit is not guaranteed to operate with all models.)

- 2 Able to connect to the internet or “App Store™” (required for software installation)

Computer

To check the image on the camera from a computer browser and to transfer videos/still images, it is necessary to meet the following requirements.

- 1 OS: Windows 7
- 2 Supports wireless LAN or wired LAN
(For direct connections between the camera and computer, support for wireless LAN is required.)
- 3 Installation of Windows Media Player 12 or later

- Confirmed operating environment:
Internet Explorer 9 or later

Caution :

- There is no guarantee that the operations will work with all computer environments. For example, the video download feature of mobile safari browser, etc. is not supported.

Memo :

- Wi-Fi feature is not available in the 60p mode.

Precautions on Using Wi-Fi

Cautions on Wi-Fi Function

- Operation is not guaranteed on all devices.
- This function is not designed for disaster or crime prevention.
- To prevent the situation of forgetting to turn off the power, this unit will turn off automatically after 10 days of continuous usage.
- Communication may not be carried out properly near radio equipment or broadcasting stations. In this case, change the location accordingly.
- Radio wave interference by Bluetooth devices
Bluetooth devices make use of the same frequency bandwidth (2.4 GHz) as that of Wi-Fi devices. Using this product near such devices may cause radio wave interference, and result in a drop in communication speed or connection failure. In this case, turn off the power of devices that are not in use.
- Security of Wireless LAN
An advantage of wireless LAN is that instead of using a LAN cable, it transmits information using radio waves, thus enabling LAN connection to be established within the area covered by the radio waves. However, as radio waves penetrate through objects (such as walls) within the range that they cover, security issues, such as interception of transmission or illegal access, may arise if security settings are not configured. Before you connect to the network in a wireless LAN environment, read through the instruction manual for the wireless LAN device in use, and configure the security settings accordingly. Failure to do so may increase the risk of personal information being intercepted, such as user names, passwords, and the content of your mails, or illegal access to the network.
- Due to the design of wireless LAN, note that security may be breached by unusual or unforeseeable means.
- For more details on wireless LAN and network security, please consult the manufacturer of your wireless LAN device.
- JVC shall not be liable for any security issues, troubles, damages or losses arising from the use of this feature.

Radio Waves Used by this Product

This product makes use of radio waves in the ISM band (2.4 GHz). Although a radio station license is not required for using this product, please take note of the following.

■ Do not use this product near the following places.

- Industrial, scientific, or medical equipment, such as microwave ovens and pacemakers
- Specified low-power radio stations (radio station license not required)
- Bluetooth devices

Equipment such as the above mentioned devices makes use of the same frequency bandwidth as that of Wi-Fi. Using this product near the above equipment may cause radio wave interference, and result in communication failure or a drop in communication speed.

■ Avoid using this product near a TV or radio set.

TV or radio sets make use of a radio wave frequency bandwidth that is different from that of Wi-Fi, and therefore has no effect on communication by this product or the TV/radio set. However, when a TV/radio set is placed close to a Wi-Fi product, electromagnetic waves emitted by the Wi-Fi product may cause noise to occur in the sound or images of the TV/radio.

■ Radio signals are unable to penetrate through reinforced steel, metal, or concrete.

The radio waves used by this product are unable to penetrate through reinforced steel, metal, or concrete materials. It may difficult for communication to be established if two rooms or floors are separated by these materials.
*Communication may also get weaker when there are human subjects or parts of the body in between the Wi-Fi devices.

■ Do not connect to wireless networks that you do not have authorization for.

Once connected, it may be considered as unauthorized access and legal actions can be taken against you.

■ Do not use the Wi-Fi function outside the country of purchase.

Depending on the country, there may be restrictions on the use of radio waves and any violations could be punishable by law.

Exporting/Bringing the Unit Overseas

Permission from the U.S. government may be required when bringing the unit to an export controlled country set by the U.S. government (such as Cuba, Iraq, North Korea, Iran, Rwanda, and Syria. As of November, 2011). For more information, consult the U.S. Embassy Commercial Service.

Image Monitoring via Direct Connection (DIRECT MONITORING)

You can check the image on the camera via direct connection (Wi-Fi Direct) with a smartphone (or computer), without the need for an access point (wireless LAN router).

- Recording of videos and still images may be performed while monitoring.

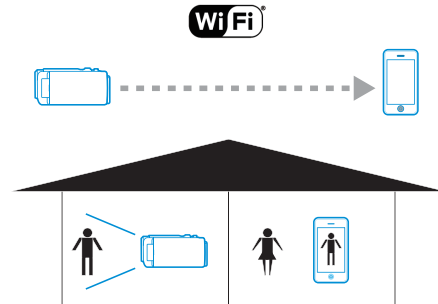

Caution :

- This function is not designed for disaster or crime prevention.
- To prevent the situation of forgetting to turn off the power, this unit will turn off automatically after 10 days of continuous usage.
- When not monitoring from a smartphone (or computer), the focus of the camera is fixed.
- Recording stops when the smartphone (or computer) is disconnected.
- Even when monitoring from a smartphone (or computer), the focus of the camera will be fixed if not operated for more than 3 hours. (Focus works again when the camera is operated.)
- You may have difficulty establishing a connection via direct monitoring in an environment where the camera is placed away from the smartphone (or computer). In this case, connect using the access point (wireless LAN router).

“Image Monitoring via an Access Point at Home (OUTSIDE MONITORING)”
(p. 18)

What You Need

- Smartphone or Windows computer
(A wireless LAN that is compatible with WPA2 is necessary.)

Necessary Settings

To operate, it is necessary to connect a smartphone (or computer) to the camera.

There are 2 ways to connect, namely “Wi-Fi Protected Setup (WPS)” and “Search and Connect”.

Select the appropriate method of connection according to the device.

■ Wi-Fi Protected Setup (WPS)

- 1 Tap “MENU”.
(Operation on this camera)

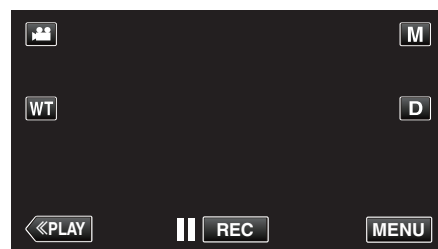

- The shortcut menu appears.
- 2 Tap “DIRECT MONITORING” (📷) in the shortcut menu.
(Operation on this camera)

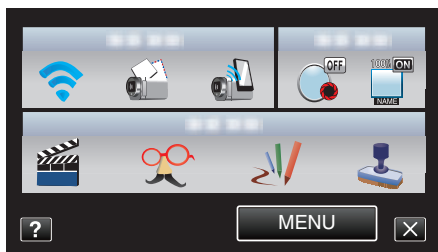

- 3 Tap "WPS".
(Operation on this camera)

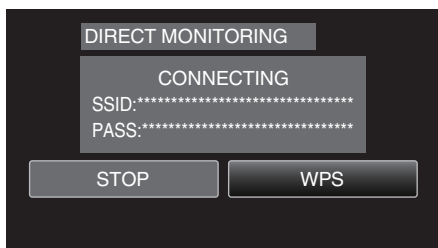

- 4 Activate WPS on the smartphone (or computer) within 2 minutes.
(Operation on the smartphone (or computer))
- To activate WPS, refer to the instruction manual of the device in use.
- 5 A connection is established and  appears on the camera's screen.

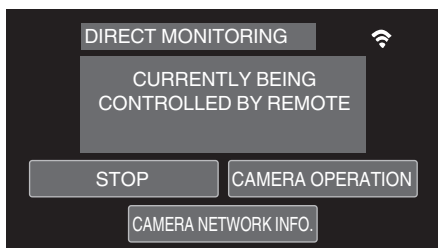

■ Search and Connect

- 1 Tap "MENU".
(Operation on this camera)

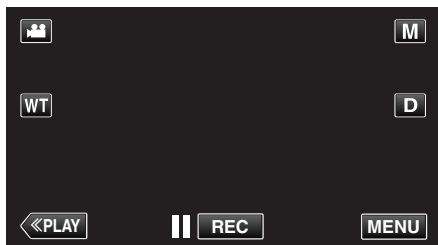

- The shortcut menu appears.

- 2 Tap "DIRECT MONITORING" () in the shortcut menu.
(Operation on this camera)

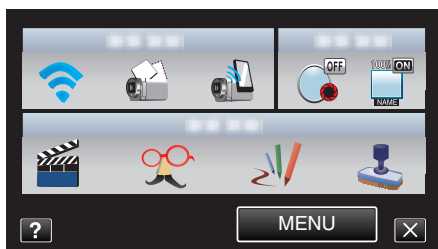

- 3 Check the SSID and PASS shown on the camera's screen, then add the smartphone (or computer) to connect.
(Operation on the smartphone (or computer))

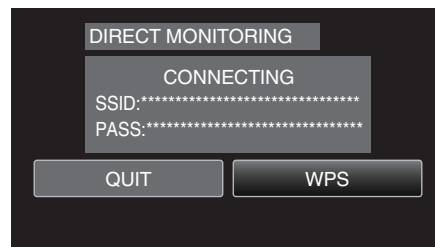

- For details on connecting your smartphone (or computer) to a Wi-Fi network, please refer to the instruction manual of the phone terminal in use.

- 4 A connection is established and  appears on the camera's screen.

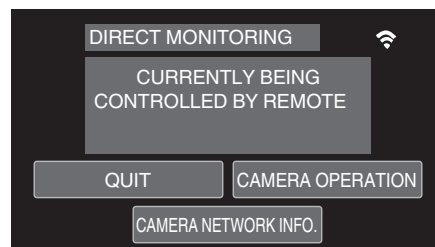

Operation Method

■ Smartphone (Android / iPhone)

Memo :

- It is necessary to install the application on the smartphone.
“Installing Smartphone Applications” (☞ p. 44)

1 Start “Everio Sync.” on the smartphone after setting direct monitoring.



2 The smartphone starts to search for the camera automatically.

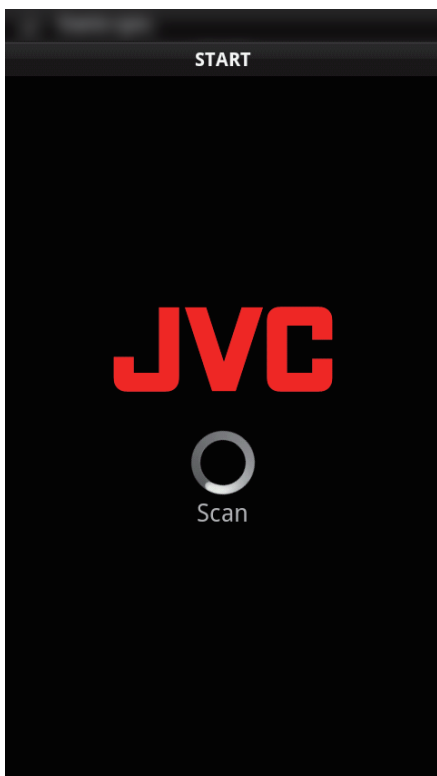

- Once the camera is found, it will be connected.

3 A connection is established.

(Adds application screen on the smartphone.)

- Tap “CAMERA OPERATION” on the camera to enable operations from it.

When operating from the camera, tap ↵ on the camera to enable operations from the smartphone application.

- Using smartphone applications

“Using Smartphone Applications” (☞ p. 44)

- To end operations, tap “STOP”.

■ Computer (Windows 7)

1 Tap “CAMERA NETWORK INFO.” after setting direct monitoring.
(Operation on this camera)



- The URL for the computer to connect to appears.

2 Check the URL.

(Adds network information screen.)

- After checking the URL, tap “QUIT” to return to the previous screen.

3 Start Internet Explorer (web browser) on the computer and enter the URL.

- Using the Wi-Fi function from the web browser

“Using the Wi-Fi Function from a Web Browser” (☞ p. 50)

- To end operations, tap “STOP”.

Recording the Location Information

You can record the location information of the venue where recording is taking place via direct connection (Wi-Fi Direct) with a smartphone.

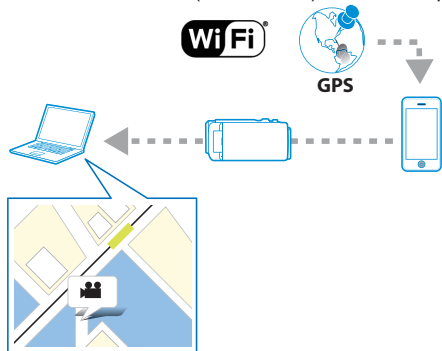

Memo :

- To obtain the location information, it is necessary to start the smartphone application and connect it to the camera. Also, setting the "LOC INFO TRANS INT" for the smartphone application is necessary.
 - "Using Smartphone Applications" (p. 44)
 - Activate the GPS function of the smartphone in advance.
 - The recorded location information can be used on the software provided with this unit.
- For more information, refer to "MediaBrowser Help".

What You Need

- Smartphone

Necessary Settings

To operate, it is necessary to connect a smartphone to the camera. There are 2 ways to connect, namely "Wi-Fi Protected Setup (WPS)" and "Search and Connect". Select the appropriate method of connection according to the device.

■ Wi-Fi Protected Setup (WPS)

- Tap "MENU".
(Operation on this camera)

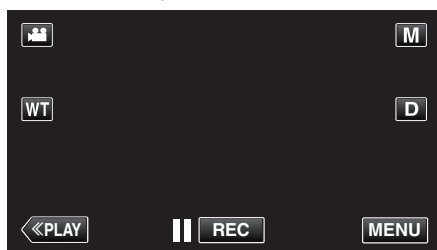

- The shortcut menu appears.
- Tap "DIRECT MONITORING" (📶) in the shortcut menu.
(Operation on this camera)

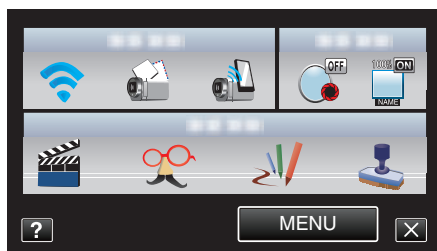

- Tap "WPS".
(Operation on this camera)

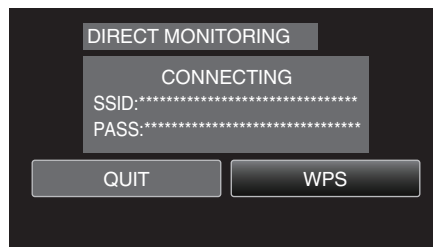

- Activate WPS on the smartphone within 2 minutes.
(Operation on the smartphone)
 - To activate WPS, refer to the instruction manual of the device in use.
 - A connection is established and 📶 appears on the camera's screen.

■ Search and Connect

- Tap "MENU".
(Operation on this camera)

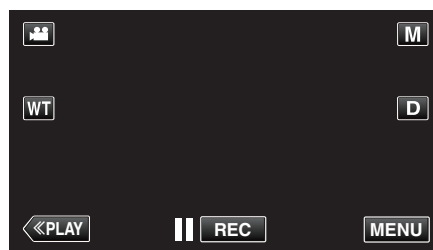

- The shortcut menu appears.

- Tap "DIRECT MONITORING" (📶) in the shortcut menu.
(Operation on this camera)



- Check the SSID and PASS shown on the camera's screen, then register them on the smartphone to connect.
(Operation on the smartphone)

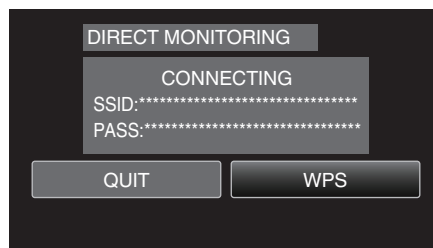

- A connection is established and 📶 appears on the camera's screen.
- For details on connecting your smartphone to a Wi-Fi network, please refer to the instruction manual of the phone terminal in use.

Operation Method

- 1 Tap "CAMERA OPERATION" after setting direct monitoring.
(Operation on this camera)



- The recording mode starts on this camera.

- 2 Activate the GPS function of the smartphone and start the application on it.

(Check the "LOC INFO TRANS INT")

"Using Smartphone Applications" (p. 44)

- 3 Start recording.
(Operation on this camera)

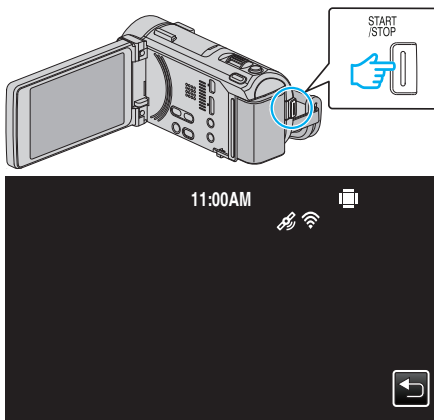

- appears on the camera's screen.
- Tap to return to the previous screen.
- To end operations, tap "STOP".

Memo :

- Manual recording cannot be performed.
- It is not possible to switch to the playback mode.
- When operations from this unit are enabled, operations from the smartphone do not work. To operate from a smartphone, tap .

Image Monitoring via an Access Point at Home (OUTSIDE MONITORING)

You can check the image on the camera with a smartphone (or computer) via an access point at home using wireless LAN router.

- Recording of videos and still images may be performed while monitoring.

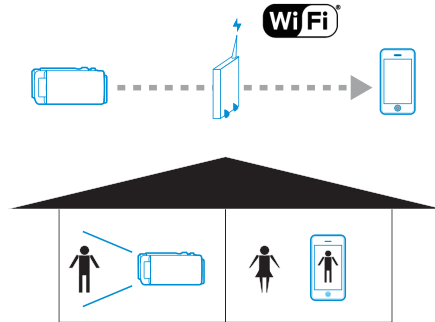

Caution :

- This function is not designed for disaster or crime prevention.
- To prevent the situation of forgetting to turn off the power, this unit will turn off automatically after 10 days of continuous usage.
- When not monitoring from a smartphone (or computer), the focus of the camera is fixed.
- Recording stops when the smartphone (or computer) is disconnected.
- Even when monitoring from a smartphone (or computer), the focus of the camera will be fixed if not operated for more than 3 hours. (Focus works again when the camera is operated.)

What You Need

- Smartphone or Windows computer
- Wireless LAN router (use a product that has a Wi-Fi certification logo)

Memo :

- Depending on the wireless LAN router in use and signal strength, you may experience connection problems or slow connections.

Necessary Settings

- To operate, it is necessary to register the access point (wireless LAN router) for the camera to connect to.
"Registering the Access Points to Connect ("ACCESS POINTS")"
(p. 36)
- In addition, it is also necessary to connect the smartphone (or computer) to the access point in advance.

*The above settings are not necessary if they have already been set for other functions.

- For details on connecting your smartphone (or computer) to a Wi-Fi network, please refer to the instruction manual of the phone terminal in use.

Operation Method

Smartphone (Android / iPhone)

Memo :

- It is necessary to install the application on the smartphone.
- “Installing Smartphone Applications” (☞ p. 44)

- Tap “MENU”.
(Operation on this camera)

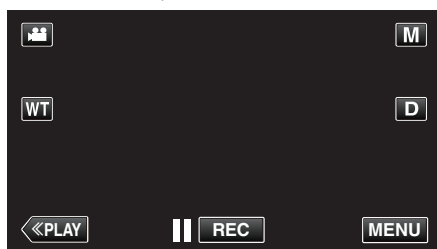

- The shortcut menu appears.

- Tap “Wi-Fi” (📶) in the shortcut menu.
(Operation on this camera)

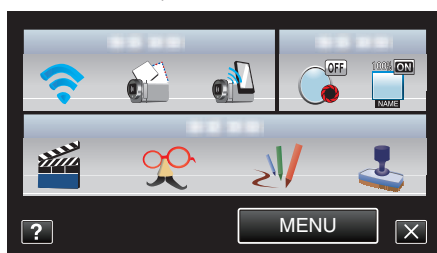

- Tap “OUTSIDE MONITORING”.
(Operation on this camera)

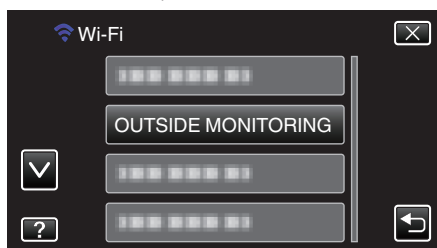

- Start “Everio Sync.” on the smartphone.



- The smartphone starts to search for the camera automatically.



- If the camera cannot be found, enter the URL (LAN) displayed in “CAMERA NETWORK INFO.” directly.
To display “CAMERA NETWORK INFO.”, refer to “Computer (Windows 7)”.

- Log in with your username and password.
(if authentication cannot be achieved)

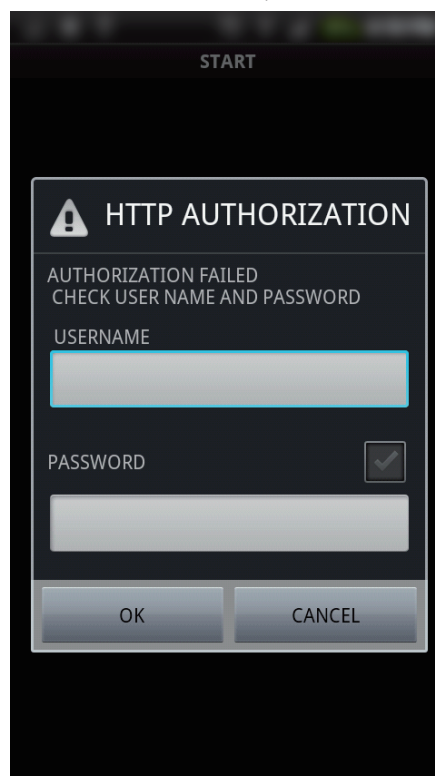

- The username is “everio” and the default password is “0000”.
“Changing the Settings” (☞ p. 28)
- Using smartphone applications
“Using Smartphone Applications” (☞ p. 44)
- To end operations, tap “STOP”.

Computer (Windows 7)

- Tap “MENU”.
(Operation on this camera)

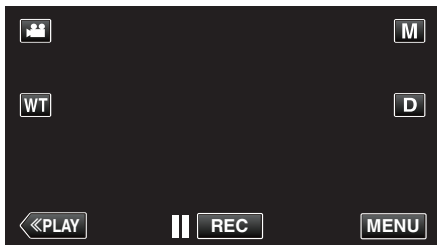

- The shortcut menu appears.

2 Tap “Wi-Fi” (📶) in the shortcut menu.
(Operation on this camera)

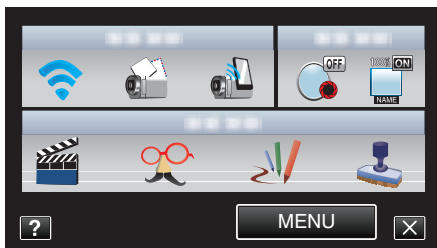

3 Tap “OUTSIDE MONITORING”.
(Operation on this camera)

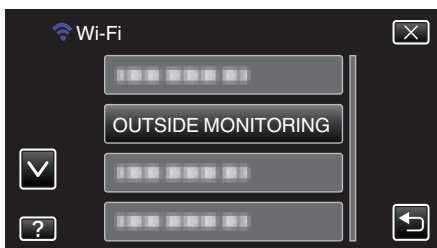

4 Tap “CAMERA NETWORK INFO.”.
(Operation on this camera)



- The URL (LAN) for the computer to connect to appears.

5 Check the URL (LAN).

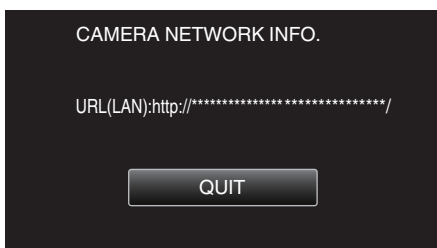

- After checking the URL, tap “QUIT” to return to the previous screen.

6 Start Internet Explorer (web browser) on the computer and enter the URL.

7 Log in with your username and password.

- The username is “everio” and the default password is “0000”.
“Changing the Settings” (☞ p. 28)
- Using the Wi-Fi function from the web browser
“Using the Wi-Fi Function from a Web Browser” (☞ p. 50)
- To end operations, tap “STOP”.

Image Monitoring via the Internet (OUTSIDE MONITORING)

You can check the image on the camera via internet connection with a smartphone (or computer).

*Connection to the internet is established via a wireless LAN router.

- Recording of videos and still images may be performed while monitoring.

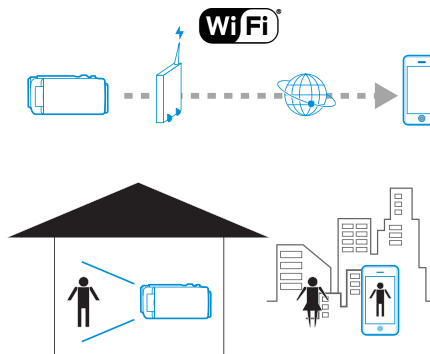

Caution :

- Too much usage may cause high communication fees to be incurred, and there may be a limit to the volume of communication. For more details, please check your Internet or smartphone subscription.
- If the network connection is slow, video images may appear jumpy, or audio sound may be interrupted or delayed.
- This function is not designed for disaster or crime prevention.
- To prevent the situation of forgetting to turn off the power, this unit will turn off automatically after 10 days of continuous usage.
- When not monitoring from a smartphone (or computer), the focus of the camera is fixed.
- Recording stops when the smartphone (or computer) is disconnected.
- Even when monitoring from a smartphone (or computer), the focus of the camera will be fixed if not operated for more than 3 hours. (Focus works again when the camera is operated.)
- To monitor images while you are out, make sure in advance that you can establish a connection via the Internet by entering the URL (WAN) displayed in “Network Information”.
However, you cannot monitor (operate) in the same way as while you are out when your smartphone (or computer) is connected to a home network via Wi-Fi.
- Start using after changing the password.
If the password is not changed, there is a high risk of unauthorized access from others.
Also, avoid using easily guessable passwords, such as birth dates.
You are recommended to change your password periodically.

“Setting the Password (OUT MONITORING SET)” (☞ p. 29)

- There is no guarantee that the operations will work with all computer environments. For example, the video download feature of mobile safari browser, etc. is not supported.

Setting Multiple Cameras in the Same Network :

Take note of the following.

- When UPnP is in use, cameras that are connected to the network later will be connected via the internet.
- To set up multiple cameras, you need to fix the IP address for each of the cameras (configure the LAN settings of the access point manually). In addition, it is also necessary to perform settings of the wireless LAN router in use manually. (For setting details, refer to the instruction manual of the wireless LAN router in use.)

“Editing LAN Settings of Access Points (Wireless LAN Router)”

(☞ p. 40)

What You Need

- Smartphone or Windows computer
- Wireless LAN router that supports UPnP (use a product that has a Wi-Fi certification logo)

To check whether UPnP is supported, please refer to the instruction manual of the wireless LAN router in use.

- Internet connection with an obtainable global IP address

Memo :

- Depending on the wireless LAN router in use and signal strength, you may experience connection problems or slow connections.

Necessary Settings

To operate, it is necessary to connect the camera to the internet via an access point (UPnP compatible wireless LAN router) in the house. As such, the following settings are required.

*The above settings are not necessary if they have already been set for other functions.

- Registering an access point

“Registering the Access Points to Connect (“ACCESS POINTS”)”
(p. 36)

- Obtaining a dynamic DNS account

“Obtaining a Dynamic DNS (DDNS) Account” (p. 30)

- Setting the account on this camera

“Setting Dynamic DNS (DDNS) on this Camera (OUT MONITORING SET)”
(p. 30)

Caution :

- Even if registration is done correctly to the camera, access may be temporarily unavailable such as when the dynamic DNS server is down. To check whether the dynamic DNS server is working properly, access and check the DDNS server with a computer, etc.

Operation Method

Smartphone (Android / iPhone)

Memo :

- It is necessary to install the application on the smartphone.
“Installing Smartphone Applications” (p. 44)

- 1 Tap “MENU”.
(Operation on this camera)

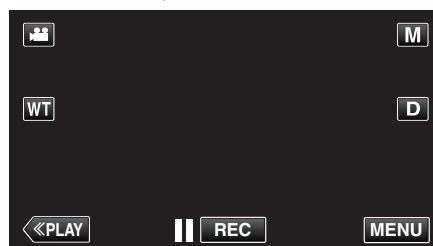

- The shortcut menu appears.

- 2 Tap “Wi-Fi” (Wi-Fi icon) in the shortcut menu.
(Operation on this camera)

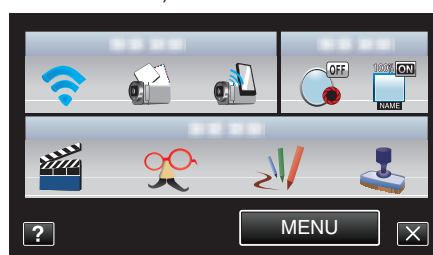

- 3 Tap “OUTSIDE MONITORING”.
(Operation on this camera)

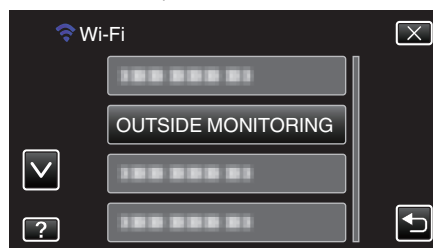

- 4 Tap “CAMERA NETWORK INFO.”.
(Operation on this camera)

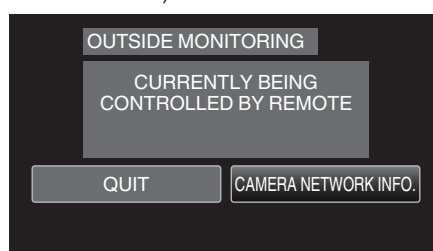

- The URL (WAN) for the smartphone to connect to appears.
(Does not appear if DDNS is not set or set incorrectly.)
- [XUPnP] is displayed when UPnP cannot be used.

- 5 Check the URL (WAN).

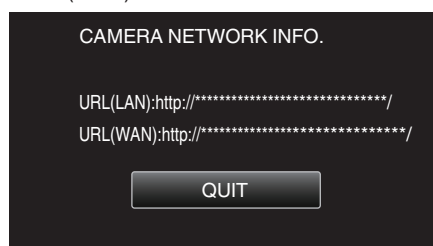

- After checking the URL, tap “QUIT” to return to the previous screen.

- 6 Start “Everio Sync.” on the smartphone.



“Changing the Settings” (☞ p. 28)

- Using smartphone applications
- “Using Smartphone Applications” (☞ p. 44)
- To end operations, tap “STOP”.

7 Enter the confirmed URL (WAN) directly.

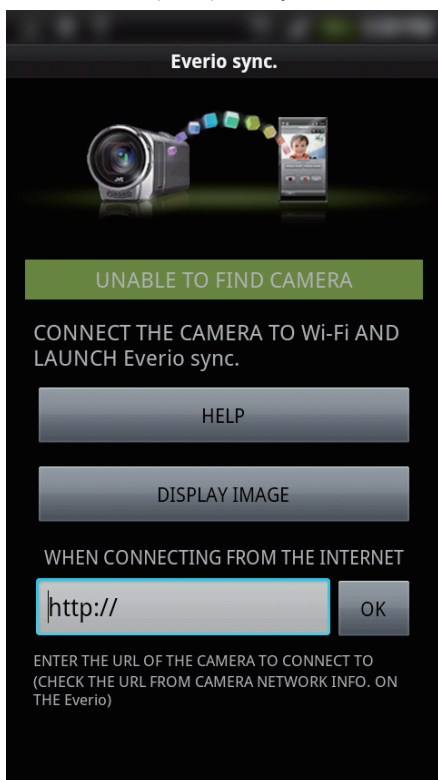

8 Log in with your username and password.
(if authentication cannot be achieved)

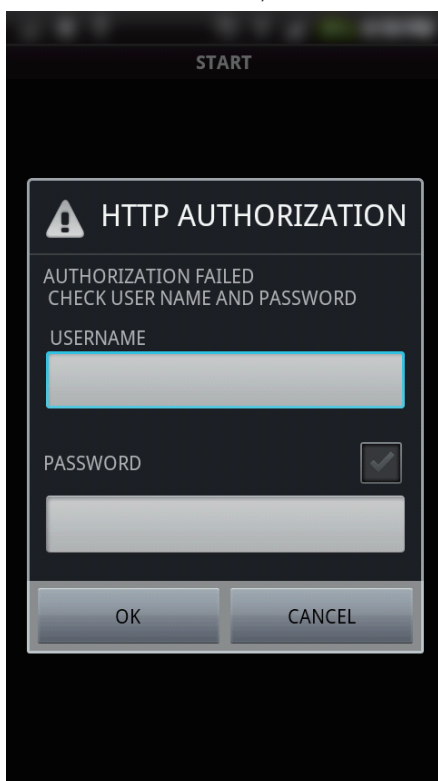

- The username is “everio” and the default password is “0000”.

■ Computer (Windows 7)

- To end operations, tap “STOP”.

- 1 Tap “MENU”.
(Operation on this camera)

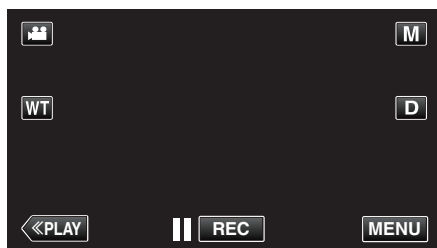

- The shortcut menu appears.

- 2 Tap “Wi-Fi” (📶) in the shortcut menu.
(Operation on this camera)

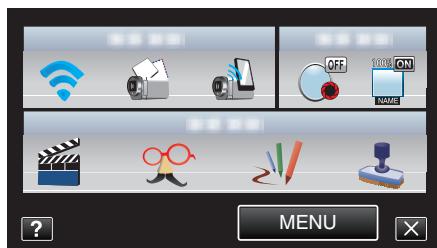

- 3 Tap “OUTSIDE MONITORING”.
(Operation on this camera)

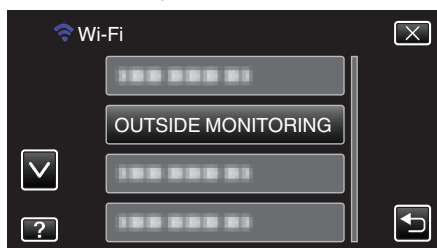

- 4 Tap “CAMERA NETWORK INFO.”.
(Operation on this camera)

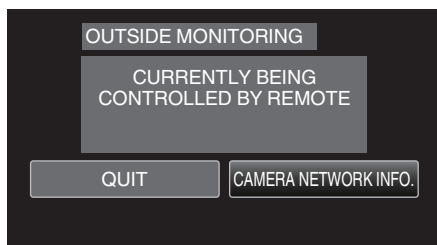

- The URL (WAN) for the computer to connect to appears.
(Does not appear if DDNS is not set or set incorrectly.)

- 5 Check the URL (WAN).

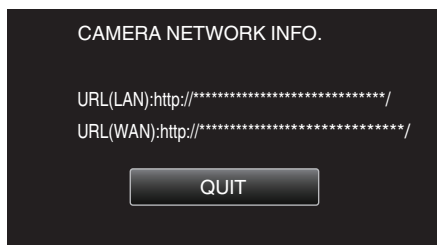

- After checking the URL, tap “QUIT” to return to the previous screen.

- 6 Start Internet Explorer (web browser) on the computer and enter the URL.

- 7 Log in with your username and password.

- The username is “everio” and the default password is “0000”.

“Changing the Settings” (☞ p. 28)

- Using the Wi-Fi function from the web browser

“Using the Wi-Fi Function from a Web Browser” (☞ p. 50)

Send Still Images via E-mail upon Detection of Face or Movement (DETECT/MAIL SETTING)

A still image is automatically captured and sent via e-mail when faces or movements are detected by the camera. Children may, for example, send still images to their parents via the camera to inform them of the happenings at home.



Memo :

- The size of the still image that is captured in “DETECT/MAIL SETTING” is 640 x 360.
- Operation via connection to a smartphone (or computer) using “OUTSIDE MONITORING” may be performed even during detection standby.
- When the camera is connected to a smartphone (or computer), “DETECT/MAIL SETTING” will be temporarily unavailable.
- You can set to record videos on this unit automatically during detection. “Recording on this unit” (☞ p. 28)
- To prevent too many e-mails from being sent in case of detections occurring frequently, you can set the interval of e-mail delivery. “Setting detection interval” (☞ p. 28)

Caution :

- This function is not designed for disaster or crime prevention.
- To prevent the situation of forgetting to turn off the power, this unit will turn off automatically after 10 days of continuous usage.
- While on standby for notification mails, the focus is fixed. Perform the camera settings first, then enable notification mails. Focus may not be set correctly if the notification mails start before camera settings are made. In this case, disable notification mails temporarily, then enable it again.
- Be careful not to cause too much sending of e-mails. Depending on the internet provider that provides the e-mail service, the e-mails may be marked as spam or the usage limited may be exceeded. Be sure to check the terms of the internet provider in advance to find out if there are any restrictions on the number or size of e-mails that can be sent.
- When setting another person as the recipient, be sure to obtain his/her consent in advance.
- If you reply to the received e-mail by using this unit, the receiver can not check your replied e-mail by using this unit. Check the e-mails sent by this unit from computer, etc.
- JVC will not be responsible for any trouble that occurs upon the sending of mails.

What You Need

- Wireless LAN router (use a product that has a Wi-Fi certification logo)
- Internet connection
- Account for sending e-mails (Supports SMTP. E-mail services that is only accessible from the web cannot be used.)

Necessary Settings

To send e-mails, the following settings are required.
*The above settings are not necessary if they have already been set for other functions.

- Registering an access point
“Registering the Access Points to Connect (“ACCESS POINTS”)” (☞ p. 36)
- Setting the account for sending e-mails
“Setting the Sender’s E-mail Address” (☞ p. 31)
- Registering the recipient’s e-mail address
“Registering the Recipient’s E-mail Address” (☞ p. 34)

■ Selecting the Recipient’s E-mail Address

- 1 Tap “MENU”.
(Operation on this camera)

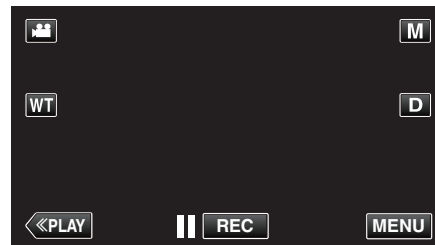

- The shortcut menu appears.

- 2 Tap “Wi-Fi” (📶) in the shortcut menu.
(Operation on this camera)

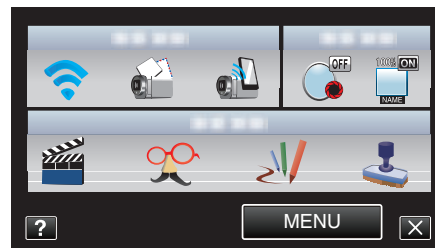

- 3 Tap “DETECT/MAIL SETTING”.
(Operation on this camera)

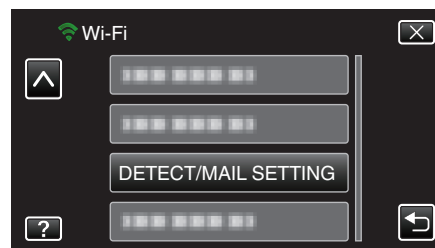

- 4 Tap “RECIPIENT’S EMAIL”.
(Operation on this camera)

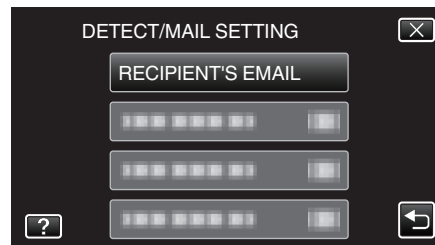

- 5 Tap the e-mail address to be set as recipient.
(Operation on this camera)

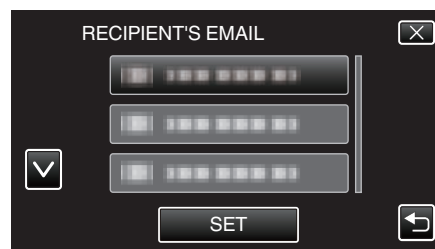

- An icon appears beside the recipient’s e-mail address.
- After setting, tap “SET”.
- Settings will not be saved until “SET” is tapped.

Operation Method

- 1 Set up the camera at the recording location.
- 2 Tap "MENU".
(Operation on this camera)

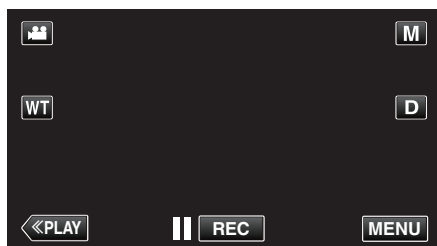

- The shortcut menu appears.

- 3 Tap "Wi-Fi" (📶) in the shortcut menu.
(Operation on this camera)



- 4 Tap "DETECT/MAIL".
(Operation on this camera)

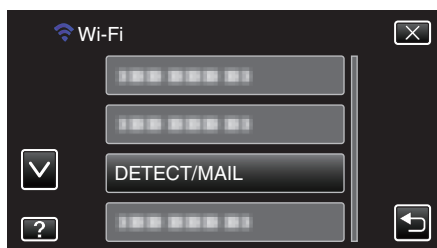

- Images are captured automatically when moving subjects or human faces appear on the camera's screen. (The PHOTO icon appears on the screen upon detection.)

"Changing the Settings" (p. 28)

- The captured still images will be sent via e-mail to the selected recipients.

Record and Send Videos via E-mail (VIDEO MAIL ATTN.)

Videos of up to 15 seconds can be recorded and sent via e-mail. With this function, short videos can be delivered easily even on a daily basis, such as to show the growing up of small children to their distant grandparents.



Memo :

- Specifications of the videos sent via video mail are as follows:
 - System: MP4
 - Video:
 - H.264/MPEG-4 AVC baseline profile codec
 - 640 x 360 resolution
 - 30p frame rate
 - 1 Mbps bit rate
 - Audio:
 - Advanced Audio Coding (AAC) system
 - 48 kHz sampling rate
 - 16 bit
 - 2 channels

Caution :

- Be careful not to cause too much sending of e-mails. Depending on the internet provider that provides the e-mail service, the e-mails may be marked as spam or the usage limited may be exceeded. Be sure to check the terms of the internet provider in advance to find out if there are any restrictions on the number or size of e-mails that can be sent.
- When setting another person as the recipient, be sure to obtain his/her consent in advance.
- Depending on the e-mail service provider, the sending of video mail may not be supported.
- Too much usage may cause high communication fees to be incurred, and there may be a limit to the volume of communication. For more details, please check your Internet or smartphone subscription.
- If you reply to the received e-mail by using this unit, the receiver can not check your replied e-mail by using this unit. Check the e-mails sent by this unit from computer, etc.
- JVC will not be responsible for any trouble that occurs upon the sending of mails.
- Videos captured via video mail are not saved to the camera or SD card.
- Videos that have already been captured cannot be sent.

What You Need

- Wireless LAN router (use a product that has a Wi-Fi certification logo)
- Internet connection
- Account for sending e-mails (Supports SMTP. E-mail services that is only accessible from the web cannot be used.)

Necessary Settings

To send e-mails, the following settings are required.

*The above settings are not necessary if they have already been set for other functions.

- Registering an access point

“Registering the Access Points to Connect (“ACCESS POINTS”)” (p. 36)

- Setting the account for sending e-mails

“Setting the Sender’s E-mail Address” (p. 31)

- Registering the recipient’s e-mail address

“Registering the Recipient’s E-mail Address” (p. 34)

■ Selecting the Recipient’s E-mail Address

- 1 Tap “MENU”.
(Operation on this camera)

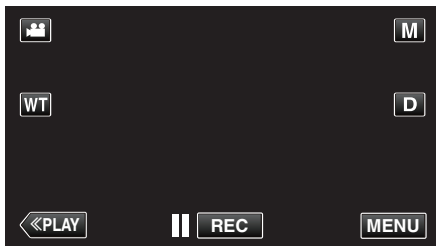

- The shortcut menu appears.

- 2 Tap “Wi-Fi” (Wi-Fi icon) in the shortcut menu.
(Operation on this camera)

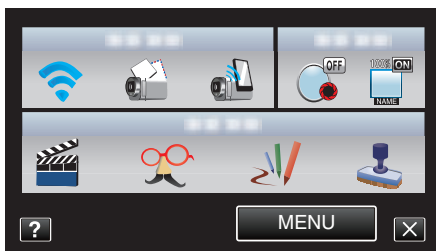

- 3 Tap “VIDEO MAIL ATTN.”.
(Operation on this camera)

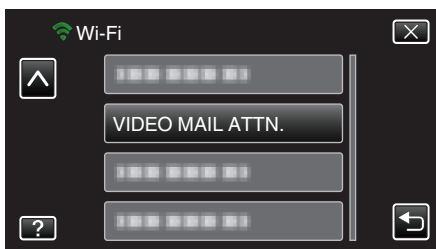

- 4 Tap the e-mail address to be set as recipient.
(Operation on this camera)

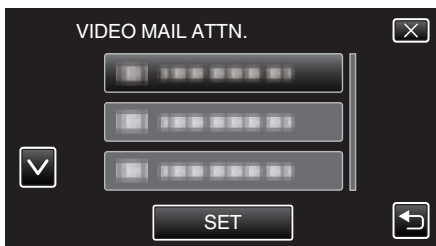

- An icon  appears beside the recipient’s e-mail address.
- After setting, tap “SET”.
- Settings will not be saved until “SET” is tapped.

Operation Method

- 1 Tap “MENU”.
(Operation on this camera)

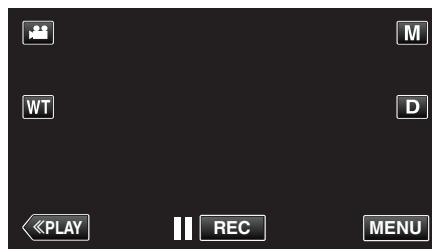

- The shortcut menu appears.

- 2 Tap “VIDEO MAIL” (video mail icon) in the shortcut menu.
(Operation on this camera)

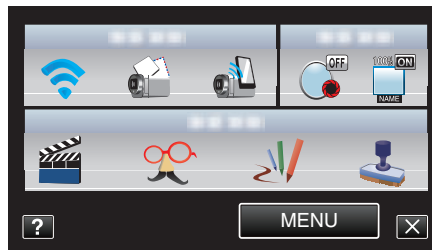

- 3 Start recording.

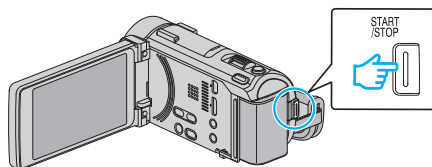

- Recording starts after the countdown (5 seconds).

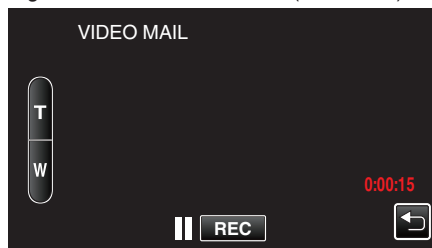

- You can allow the recording to be performed for 15 seconds or press the START/STOP button to stop.

- 4 Tap “SEND”.
(Operation on this camera)

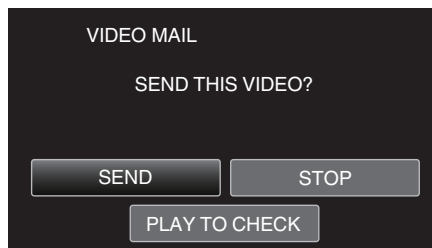

- Sending of the video mail starts.
- To check the file, tap “PLAY TO CHECK”.
- When it is complete, tap “OK”.

Changing the Settings

To use the Wi-Fi function, it may be necessary to perform some settings on the camera and smartphone (or computer).

- Registering the access points to connect (wireless LAN router)

“Registering the Access Points to Connect (“ACCESS POINTS”)”

(☞ p. 36)

- Obtaining a dynamic DNS account

“Obtaining a Dynamic DNS (DDNS) Account” (☞ p. 30)

- Setting the account on this camera

“Setting Dynamic DNS (DDNS) on this Camera (OUT MONITORING SET)”

(☞ p. 30)

- Setting the sender’s e-mail address

“Setting the Sender’s E-mail Address” (☞ p. 31)

- Registering the recipient’s e-mail address

“Registering the Recipient’s E-mail Address” (☞ p. 34)

Menu Settings

Setting	Details
OUT MONITORING SET	<p>Configures various settings related to outside monitoring.</p> <ul style="list-style-type: none"> • PASSWORD (Default: "0000") Selects the password to access the camera. "Setting the Password (OUT MONITORING SET)" (p. 29) • UPnP (Default: "ON") Sets the UPnP of the camera. <ul style="list-style-type: none"> • OFF: Disables UPnP. • ON: Enables UPnP. "Setting the UPnP of this Camera (OUT MONITORING SET)" (p. 29) • DDNS SETTING Configures various settings related to DDNS. "Setting Dynamic DNS (DDNS) on this Camera (OUT MONITORING SET)" (p. 30)
VIDEO MAIL ATTN.	<p>Selects the recipient's e-mail address for video mails. "Record and Send Videos via E-mail (VIDEO MAIL ATTN.)" (p. 26)</p>
DETECT/MAIL SETTING	<p>Configures various settings related to notification mails.</p> <ul style="list-style-type: none"> • RECIPIENT'S EMAIL Selects the recipient's e-mail address for notification mails. "Registering the Recipient's E-mail Address" (p. 34) • DETECTION METHOD (Default: "MOTION DETECTION") Sets the detection method to start recording. <ul style="list-style-type: none"> • MOTION DETECTION: Starts recording upon detection of subject's movements. • FACE DETECTION: Starts recording upon detection of human faces. "Setting the Detection Method of this Camera (DETECT/MAIL SETTING)" (p. 35) • DETECTION INTERVAL (Default: "10 minutes") Sets the time period to enable detection again after the previous one. "Setting the Detection Interval of this Camera (DETECT/MAIL SETTING)" (p. 35) • SELF RECORDING (Default: "ON") Sets whether to record videos on this camera during detection. <ul style="list-style-type: none"> • OFF: Does not record videos on this camera. • ON: Records videos on this camera. "Setting Self Recording on this Camera (DETECT/MAIL SETTING)" (p. 36)
NETWORK SETTINGS	<p>Configures various settings related to the network.</p> <ul style="list-style-type: none"> • ACCESS POINTS Adds, deletes, or perform LAN settings of access points (wireless LAN router). "Registering the Access Points to Connect ("ACCESS POINTS")" (p. 36) • Wi-Fi DIRECT SETTING Configures various settings related to direct monitoring. <ul style="list-style-type: none"> • PASSWORD Sets the password for direct monitoring. ENFORCED GROUP OWNER (Default: "ON") Sets whether to enforce authorization of the group owner. <ul style="list-style-type: none"> • OFF: Set this if connection to devices that support Wi-Fi Direct fails. (When set to OFF, connection to devices that do not support Wi-Fi Direct will be disabled.) • ON: It is recommended to set this usually. "Setting the Password (DIRECT MONITORING)" (p. 41) "Setting the Enforced Group Owner (DIRECT MONITORING)" (p. 42) • MAIL SETTING Sets the e-mail addresses of the sender and recipient. "Setting the Sender's E-mail Address" (p. 31) "Registering the Recipient's E-mail Address" (p. 34) • MAC ADDRESS Displays the MAC address of the camera. (The above shows the MAC address when connected to an access point, while the below shows the address during direct connection.) "Checking the MAC Address of this Camera" (p. 42) • SET FROM WEB BROWSER Enables configuration of the camera settings from a web browser. "Using the Wi-Fi Function from a Web Browser" (p. 50) • LOCK SETTINGS Sets a password to prevent others from seeing the network settings. "Protecting the Network Settings with a Password" (p. 43) • INITIALIZATION Returns the network settings to their default values. "Initializing the Network Settings" (p. 43)

Setting the Password (OUT MONITORING SET)

Sets the password to access the camera. (Not more than 8 characters)

- 1 Tap "MENU".
(Operation on this camera)

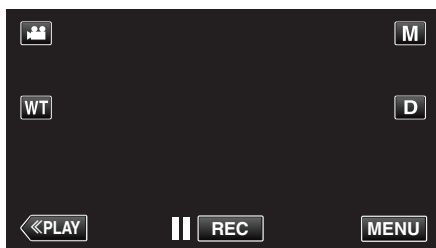

- The shortcut menu appears.

- 2 Tap "Wi-Fi" (📶) in the shortcut menu.
(Operation on this camera)

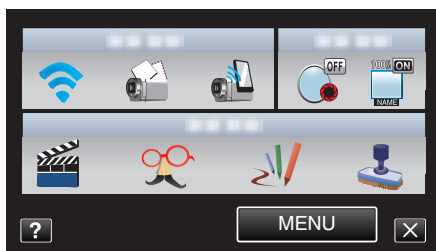

- 3 Tap "OUT MONITORING SET".
(Operation on this camera)

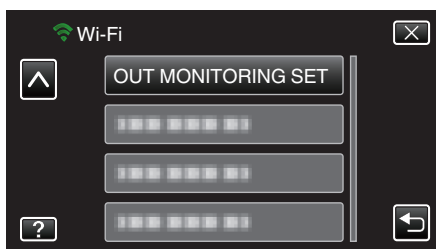

- 4 Tap "PASSWORD".
(Operation on this camera)

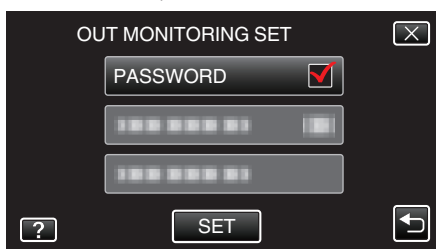

- 5 Enter the password.
(Operation on this camera)



- Tap on the on-screen keyboard to enter characters. The character changes with every tap.
- Tap "DELETE" to delete a character.
- Tap "CANCEL" to exit.
- Tap "A/a/1" to select character input type from upper case letter, lower case letter, and number.
- Tap ← or → to move one space to the left or right.
- After setting, tap "SET".

Setting the UPnP of this Camera (OUT MONITORING SET)

Sets the UPnP of the camera.

- 1 Tap "MENU".
(Operation on this camera)

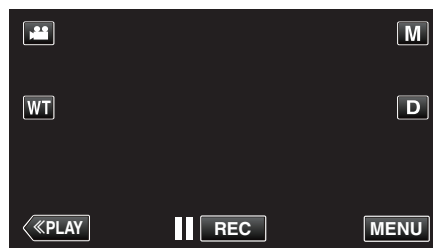

- The shortcut menu appears.

- 2 Tap "Wi-Fi" (📶) in the shortcut menu.
(Operation on this camera)

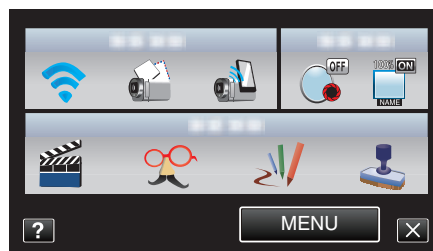

- 3 Tap "OUT MONITORING SET".
(Operation on this camera)

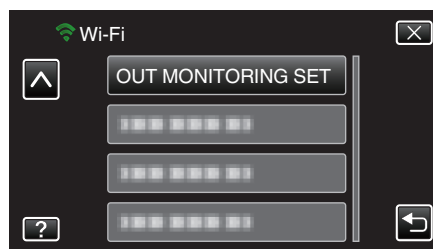

- 4 Tap "UPnP".
(Operation on this camera)

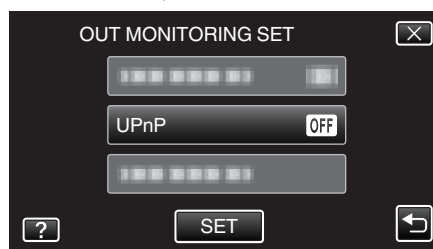

- Tap "ON" or "OFF".
- Select "ON" to enable UPnP.
- Select "OFF" to disable UPnP.
- After setting, tap "SET".

Obtaining a Dynamic DNS (DDNS) Account

By obtaining a dynamic DNS account, this unit may be used on the web as usual even if the IP address changes when it is connected to the internet.

- Only the JVC dynamic DNS service can be set on this camera.

To obtain (register) an account, perform the following steps.

- 1 Access the following URL and register for an account.
(Operation on a computer or smartphone)
<https://dd3.jvckenwood.com/user/>
Set your e-mail address as the username.
- 2 Check that you have received a confirmation e-mail to the address used in registration, and access the URL stated in the e-mail.
(Operation on a computer or smartphone)
- 3 Set the username and password used in registration on the camera.
(Operation on this camera)
"Setting Dynamic DNS (DDNS) on this Camera (OUT MONITORING SET)" (p. 30)
- 4 Execute "OUTSIDE MONITORING".
(Operation on this camera)
If "OUTSIDE MONITORING" is executed while dynamic DNS settings are enabled, the camera will access the dynamic DNS server.
- 5 Tap "CAMERA NETWORK INFO." to check that the URL (WAN) is displayed.
(Registration complete)
"Image Monitoring via the Internet (OUTSIDE MONITORING)" (p. 20)

Caution :

- Registration will be canceled if you do not access the dynamic DNS server from the camera within 3 days.
Perform the registration again in this case.
- Registration will not be complete if the username and password set on this camera are incorrect. Be sure to check that they are correct.
- Successful registration will be canceled too if you do not access the dynamic DNS server for 1 year.

Setting Dynamic DNS (DDNS) on this Camera (OUT MONITORING SET)

Sets the dynamic DNS information of the obtained account on the camera.

- 1 Tap "MENU".
(Operation on this camera)

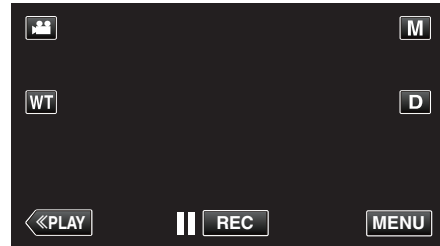

- The shortcut menu appears.

- 2 Tap "Wi-Fi" (Wi-Fi icon) in the shortcut menu.
(Operation on this camera)

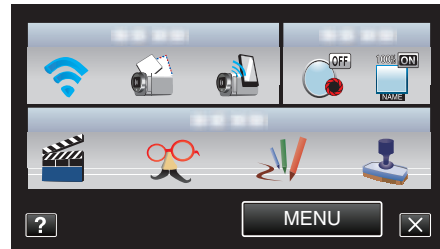

- 3 Tap "OUT MONITORING SET".
(Operation on this camera)

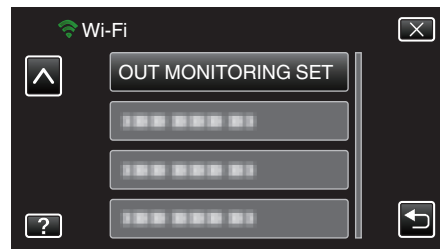

- 4 Tap "DDNS SETTING".
(Operation on this camera)

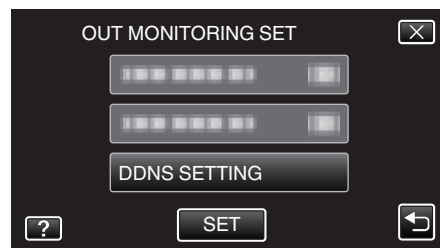

- 5 Tap "DDNS", then tap "ON".
(Operation on this camera)

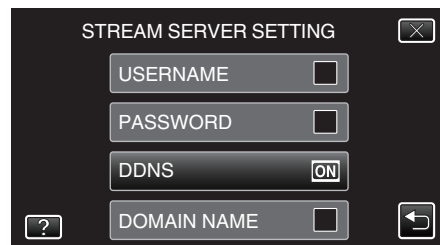

- 6 Enter the DDNS settings (username/password).
(Operation on this camera)



- Tap "USERNAME" or "PASSWORD" to display the respective input screens.
- Tap on the on-screen keyboard to enter characters. The character changes with every tap.
- Tap "DELETE" to delete a character.
- Tap "CANCEL" to exit.
- Tap "A/a/1" to select character input type from upper case letter, lower case letter, and number.
- Tap ← or → to move one space to the left or right.
- After setting, tap "SET".

Memo : _____

- Only the JVC dynamic DNS service can be set on this camera.

Setting the Sender's E-mail Address

Sets the address to be used for sending e-mails on the camera.

Memo : _____

- By using Gmail as the sender's mail address, some of the settings can be omitted.
Use of Gmail is recommended for users who have a Gmail account.

- 1 Tap "MENU".
(Operation on this camera)

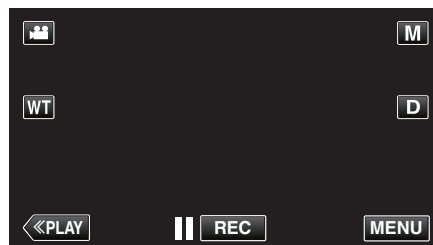

- The shortcut menu appears.

- 2 Tap "Wi-Fi" (📶) in the shortcut menu.
(Operation on this camera)

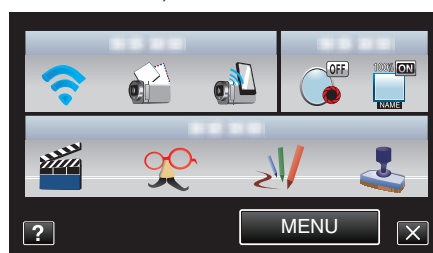

- 3 Tap "NETWORK SETTINGS".
(Operation on this camera)

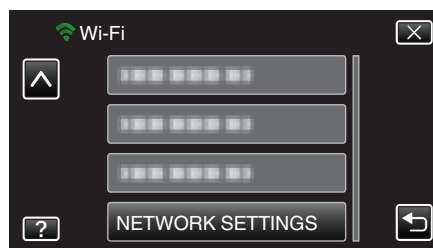

- 4 Tap "MAIL SETTING".
(Operation on this camera)

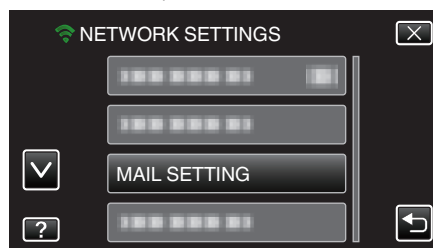

- 5 Tap "SENDER'S EMAIL".
(Operation on this camera)

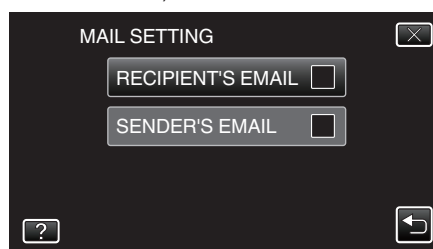

- Enter the e-mail address and tap "SET".

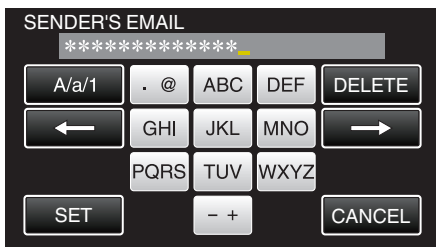

- Tap on the on-screen keyboard to enter characters. The character changes with every tap.
- Tap "DELETE" to delete a character.
- Tap "CANCEL" to exit.
- Tap "A/a/1" to select character input type from upper case letter, lower case letter, and number.
- Tap ← or → to move one space to the left or right.
- After setting, tap "SET".

6 Tap "SMTP SERVER" (not necessary in the case of Gmail) (Operation on this camera)

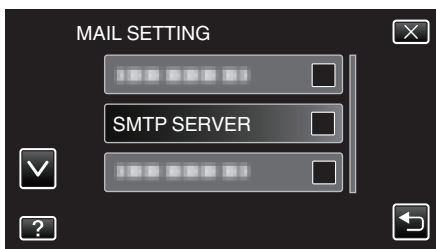

- Enter the SMTP server and tap "SET".



- This is automatically configured if the sender's mail address is Gmail.
- Tap on the on-screen keyboard to enter characters. The character changes with every tap.
- Tap "DELETE" to delete a character.
- Tap "CANCEL" to exit.
- Tap "A/a/1" to select character input type from upper case letter, lower case letter, and number.
- Tap ← or → to move one space to the left or right.
- After setting, tap "SET".

7 Tap "SMTP PORT" (not necessary in the case of Gmail)

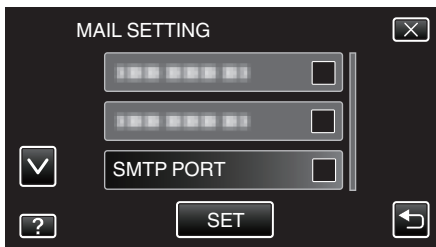

- Change the SMTP port number (if necessary) and tap "SET".



- This is automatically configured if the sender's mail address is Gmail.

- Tap on the on-screen keyboard to enter characters. The character changes with every tap.
- Tap "DELETE" to delete a character.
- Tap "CANCEL" to exit.
- Tap ← or → to move one space to the left or right.
- After setting, tap "SET".

8 Tap "AUTHENTICATE METHOD" (not necessary in the case of Gmail)



- Tap the desired "AUTHENTICATE METHOD".

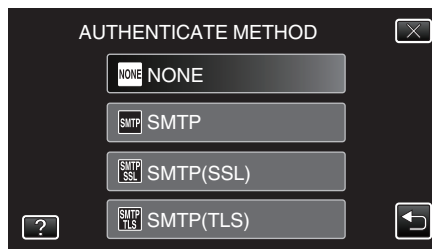

- This is automatically configured if the sender's mail address is Gmail.

9 Tap "USERNAME".

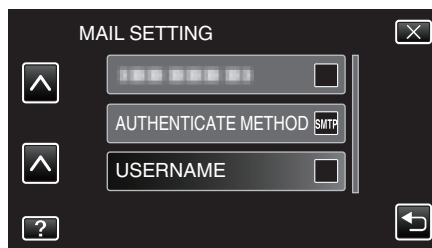

- Enter the username and tap SET.



- For Gmail mail addresses, enter the name to the left of "@".
- Tap on the on-screen keyboard to enter characters. The character changes with every tap.
- Tap "DELETE" to delete a character.
- Tap "CANCEL" to exit.
- Tap "A/a/1" to select character input type from upper case letter, lower case letter, and number.
- Tap ← or → to move one space to the left or right.
- After setting, tap "SET".

10 Tap "PASSWORD".

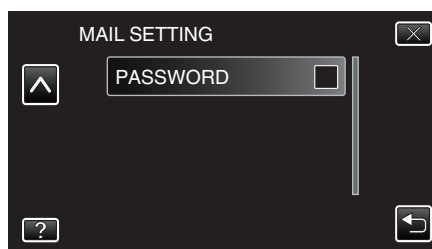

- Enter the password and tap "SET".



- Tap on the on-screen keyboard to enter characters. The character changes with every tap.
- Tap “DELETE” to delete a character.
- Tap “CANCEL” to exit.
- Tap “A/a/1” to select character input type from upper case letter, lower case letter, and number.
- Tap ← or → to move one space to the left or right.
- After setting, tap “SET”.

11 After setting all the necessary items, tap “SET”.

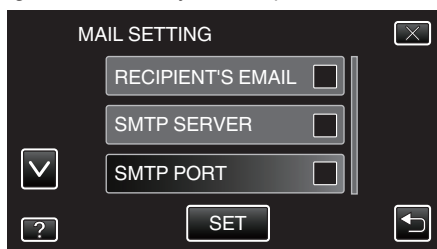

- Settings will not be saved until “SET” is tapped.

SENDER'S EMAIL	Enter the sender's e-mail address.
SMTP SERVER	Enter the SMTP server address.
SMTP PORT	Set this when the SMTP port number needs to be changed.
AUTHENTICATE METHOD	Set this when the authentication method needs to be changed.
USERNAME	Enter the username.
PASSWORD	Enter the password.

Caution :

- It is necessary to obtain an e-mail account in advance.
- Some web-based mail addresses do not support this feature.
- These are Gmail settings as of January 2012.
Perform setting manually if changes have been made to the Gmail specifications.
- To make use of addresses other than Gmail, please consult the mail service provider (Internet provider, etc.) for information on the settings.

Registering the Recipient's E-mail Address

Registers the e-mail addresses of recipients on the camera.

- 1 Tap "MENU".
(Operation on this camera)

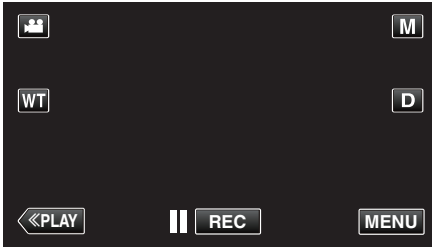

- The shortcut menu appears.

- 2 Tap "Wi-Fi" (📶) in the shortcut menu.
(Operation on this camera)

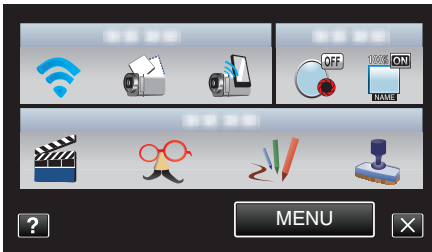

- 3 Tap "NETWORK SETTINGS".
(Operation on this camera)

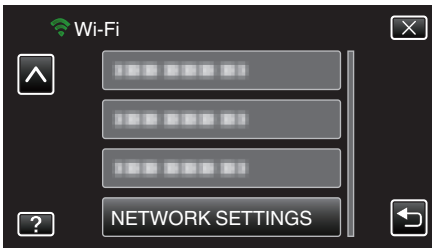

- 4 Tap "MAIL SETTING".
(Operation on this camera)

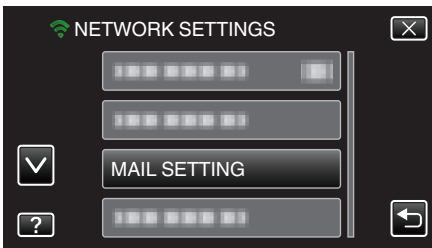

- 5 Tap "RECIPIENT'S EMAIL".
(Operation on this camera)

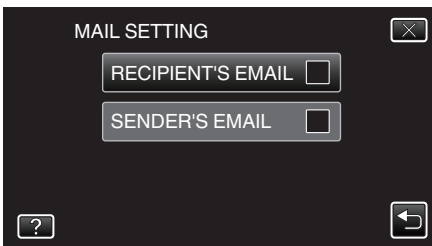

- 6 Tap "ADD".
(Operation on this camera)

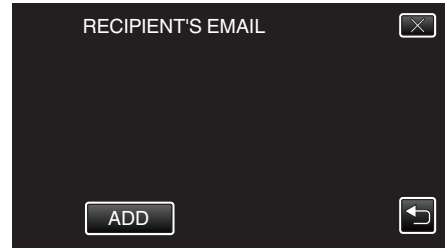

- 7 Enter the recipient's e-mail address.

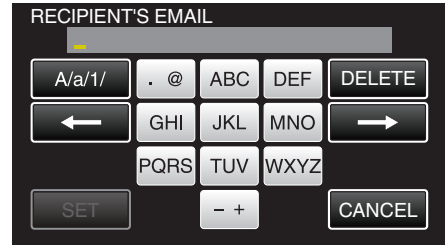

- Tap on the on-screen keyboard to enter characters. The character changes with every tap.
- Tap "DELETE" to delete a character.
- Tap "CANCEL" to exit.
- Tap "A/a/1" to select character input type from upper case letter, lower case letter, and number.
- Tap ← or → to move one space to the left or right.
- After setting, tap "SET".

Memo :

- Up to 8 e-mail addresses can be registered as recipients.

Caution :

- When setting another person as the recipient, be sure to obtain his/her consent in advance.
- Check whether notifications indicating errors have been sent to the sender's e-mail address. (Make use of a computer or similar devices as it is not possible to check from the camera.)

If no notifications are received: Refer to "Unable to send e-mails." and adjust the settings accordingly.

If notifications are received: Check the content of the notification.

*Note

Do not continue sending e-mails with the same settings if you receive error notifications. Depending on the provider, you may be marked as a sender of spam (junk mail).

Setting the Detection Method of this Camera (DETECT/MAIL SETTING)

Sets the detection method to start recording.

- 1 Tap "MENU".
(Operation on this camera)

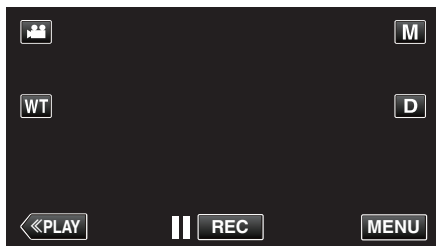

- The shortcut menu appears.

- 2 Tap "Wi-Fi" (📶) in the shortcut menu.
(Operation on this camera)

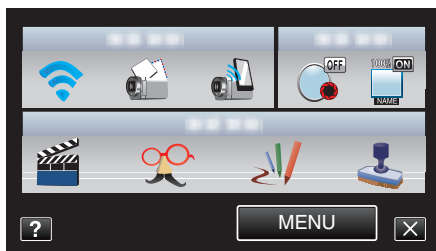

- 3 Tap "DETECT/MAIL SETTING".
(Operation on this camera)

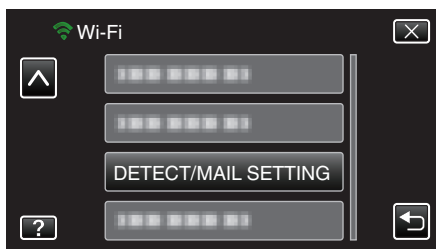

- 4 Tap "DETECTION METHOD".
(Operation on this camera)

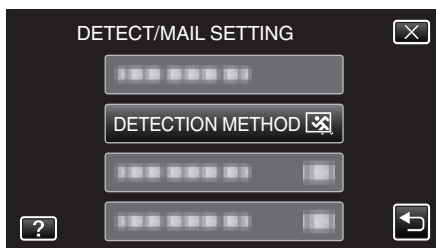

- Tap "MOTION DETECTION" or "FACE DETECTION".
- Select "MOTION DETECTION" to start recording upon detection of subject's movements.
- Select "FACE DETECTION" to start recording upon detection of human faces.

Setting the Detection Interval of this Camera (DETECT/MAIL SETTING)

Sets the time period to enable detection again after the previous one.

- 1 Tap "MENU".
(Operation on this camera)

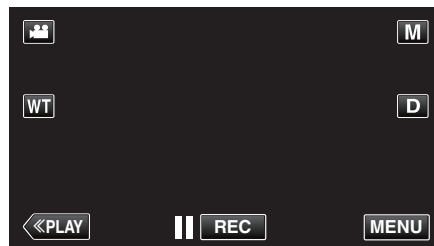

- The shortcut menu appears.

- 2 Tap "Wi-Fi" (📶) in the shortcut menu.
(Operation on this camera)

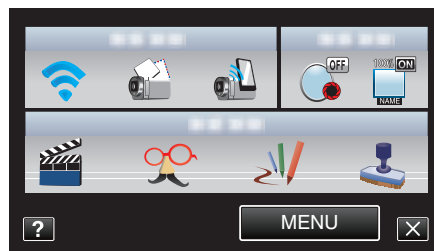

- 3 Tap "DETECT/MAIL SETTING".
(Operation on this camera)

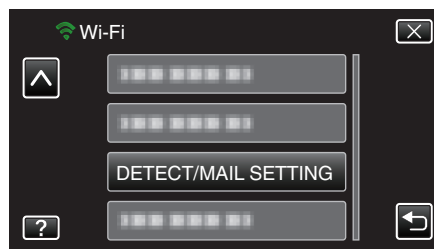

- 4 Tap "DETECTION INTERVAL".
(Operation on this camera)

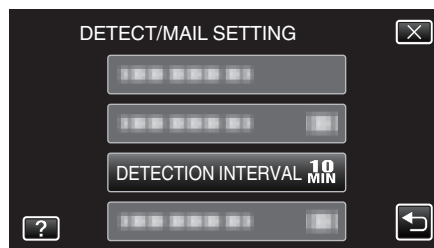

- Set the interval to perform detection. By default, it is set to 10 minutes.

Setting Self Recording on this Camera (DETECT/MAIL SETTING)

Sets whether to record videos on this camera during detection.

- 1 Tap "MENU".
(Operation on this camera)

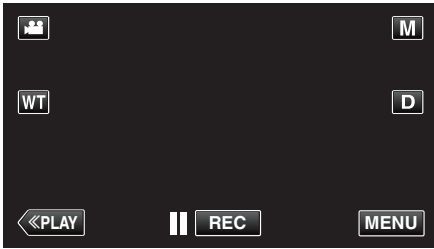

- The shortcut menu appears.

- 2 Tap "Wi-Fi" (Wi-Fi icon) in the shortcut menu.
(Operation on this camera)

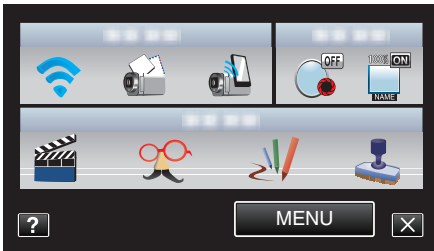

- 3 Tap "DETECT/MAIL SETTING".
(Operation on this camera)

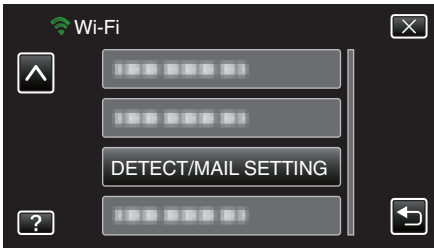

- 4 Tap "SELF RECORDING".
(Operation on this camera)

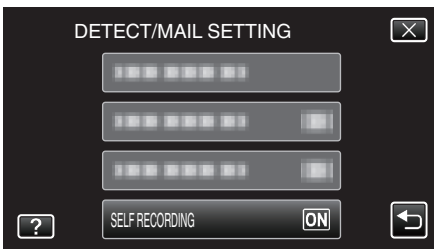

- Tap "ON" or "OFF".
- Select "ON" to record videos on this camera.
- Select "OFF" not to record videos on this camera.

Registering the Access Points to Connect ("ACCESS POINTS")

There are 4 ways to register the access points (wireless LAN router) for connection.

Wi-Fi Protected Setup (WPS) Registration	This is the easiest way of registration. Authentication method and wireless LAN setup are performed automatically in WPS, allowing easy registration of connection settings between devices.
Search and Register	A search is conducted to locate access points. Select and register an access point from the list of search results.
Manual Registration	Enter the name and authentication method manually to register an access point.
WPS PIN Registration	Enter the WPS PIN code of the camera to the access point to register.

Memo :

- By registering multiple access points, you can change connection to another access point by tapping on the desired one from the list.

■ Wi-Fi Protected Setup (WPS) Registration

- 1 Tap "MENU".
(Operation on this camera)

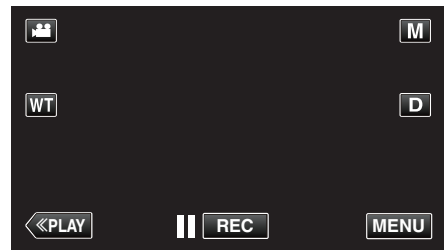

- The shortcut menu appears.

- 2 Tap "Wi-Fi" (Wi-Fi icon) in the shortcut menu.
(Operation on this camera)

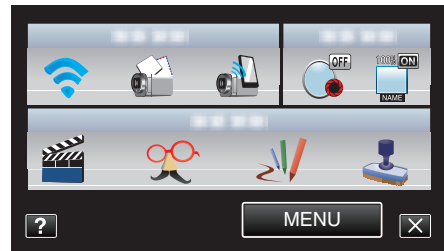

- 3 Tap "NETWORK SETTINGS".
(Operation on this camera)

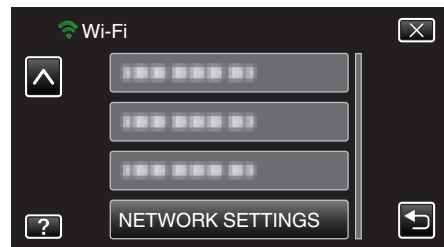

- 4 Tap "ACCESS POINTS".
(Operation on this camera)

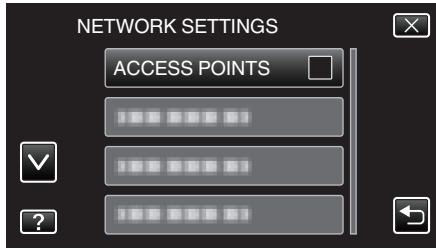

- 5 Tap "ADD".
(Operation on this camera)

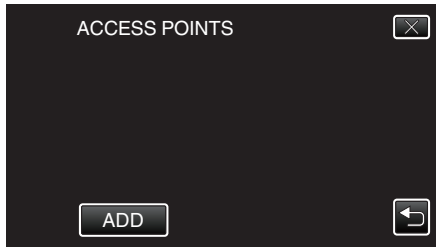

- 6 Tap "EZ REGISTRATION WPS".
(Operation on this camera)

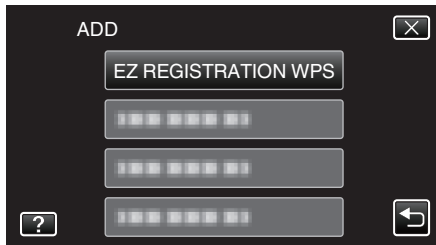

- 7 Activate WPS of the access point (wireless LAN router) within 2 minutes.
 - To activate WPS, refer to the instruction manual of the device in use.
- 8 After registration is complete, tap "OK" on the camera's screen.
(Operation on this camera)

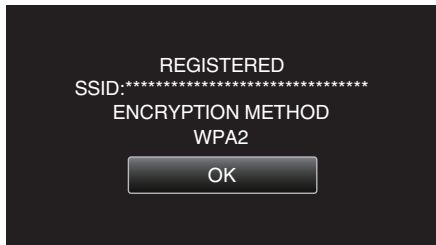

■ Search and Register

- 1 Tap "MENU".
(Operation on this camera)



- The shortcut menu appears.

- 2 Tap "Wi-Fi" (Wi-Fi icon) in the shortcut menu.
(Operation on this camera)

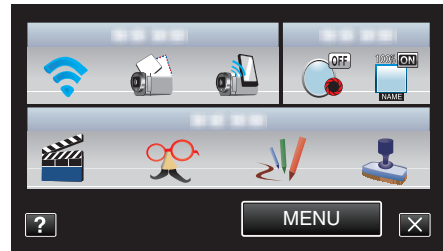

- 3 Tap "NETWORK SETTINGS".
(Operation on this camera)

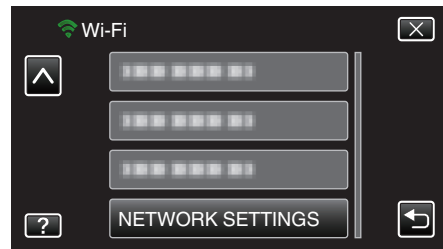

- 4 Tap "ACCESS POINTS".
(Operation on this camera)

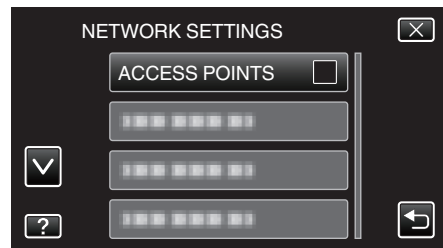

- 5 Tap "ADD".
(Operation on this camera)

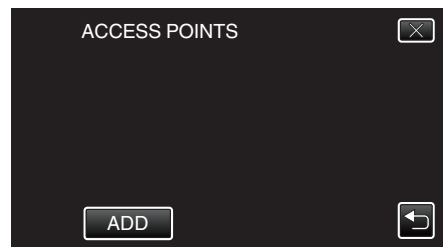

- 6 Tap "SEARCH".
(Operation on this camera)

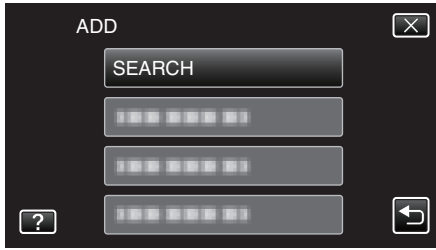

- The search results appear on the camera's screen.

- 7 Tap the name (SSID) of the desired access point from the list of search results.
(Operation on this camera)

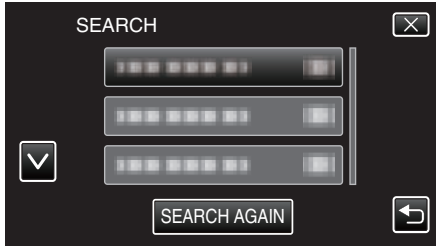

- 8 Enter the password.
(Operation on this camera)



- Tap on the on-screen keyboard to enter characters. The character changes with every tap.
- Tap "DELETE" to delete a character.
- Tap "CANCEL" to exit.
- Tap "A/a/1" to select character input type from upper case letter, lower case letter, and number.
- Tap ← or → to move one space to the left or right.
- The password is not required if the wireless LAN router is not security protected.

- 9 After registration is complete, tap "OK" on the camera's screen.
(Operation on this camera)

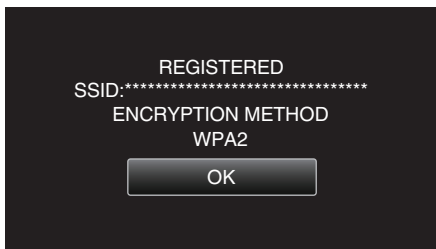

Manual Registration

- 1 Tap "MENU".
(Operation on this camera)

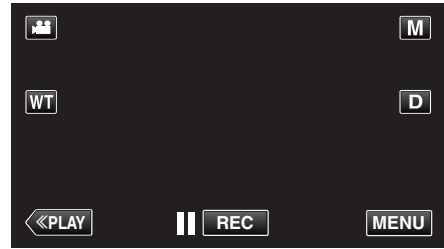

- The shortcut menu appears.

- 2 Tap "Wi-Fi" (Wi-Fi icon) in the shortcut menu.
(Operation on this camera)

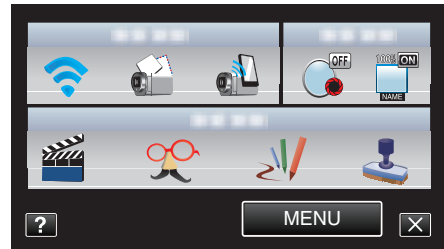

- 3 Tap "NETWORK SETTINGS".
(Operation on this camera)

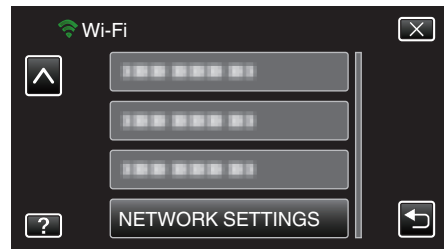

- 4 Tap "ACCESS POINTS".
(Operation on this camera)

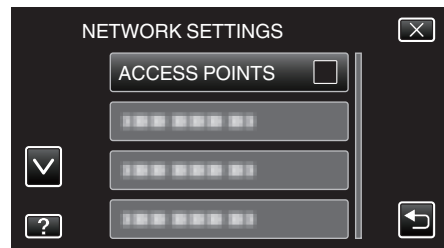

- 5 Tap "ADD".
(Operation on this camera)

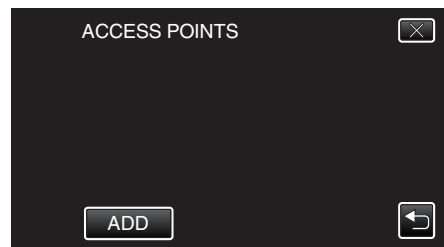

- 6 Tap "MANUAL".
(Operation on this camera)

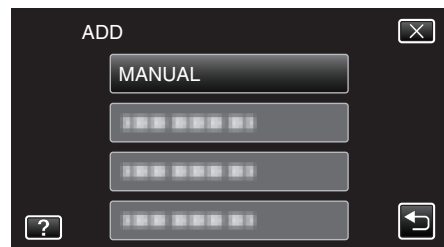

- 7 Enter the name (SSID) of the access point (wireless LAN router) and tap "SET".
(Operation on this camera)



- Tap on the on-screen keyboard to enter characters. The character changes with every tap.
- Tap "DELETE" to delete a character.
- Tap "CANCEL" to exit.
- Tap "A/a/1" to select character input type from upper case letter, lower case letter, and number.
- Tap ← or → to move one space to the left or right.

- 8 Select the type of authentication method (security).
(Operation on this camera)



- Select according to the setting of your router.

- 9 When authentication method is not set to "NONE", enter a password and tap "SET".
(Operation on this camera)



- Tap on the on-screen keyboard to enter characters. The character changes with every tap.
- Tap "DELETE" to delete a character.
- Tap "CANCEL" to exit.
- Tap "A/a/1" to select character input type from upper case letter, lower case letter, and number.
- Tap ← or → to move one space to the left or right.

- 10 After registration is complete, tap "OK" on the camera's screen.
(Operation on this camera)



■ WPS PIN Registration

- 1 Tap "MENU".
(Operation on this camera)

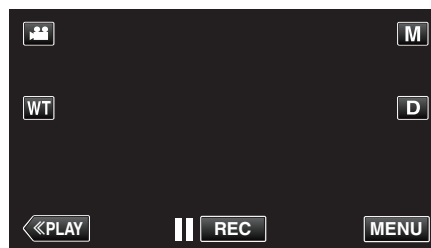

- The shortcut menu appears.

- 2 Tap "Wi-Fi" (Wi-Fi icon) in the shortcut menu.
(Operation on this camera)

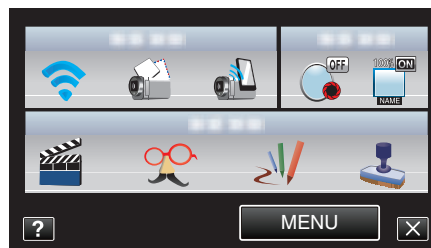

- 3 Tap "NETWORK SETTINGS".
(Operation on this camera)

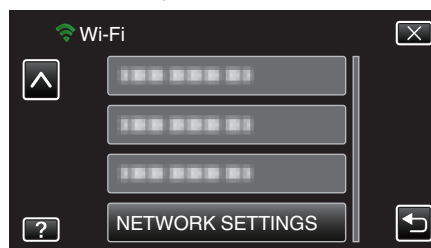

- 4 Tap "ACCESS POINTS".
(Operation on this camera)

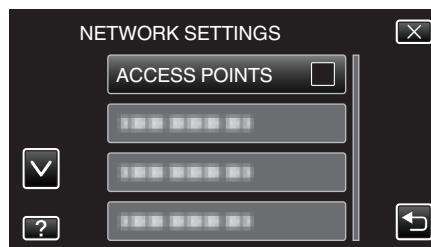

- 5 Tap "ADD".
(Operation on this camera)

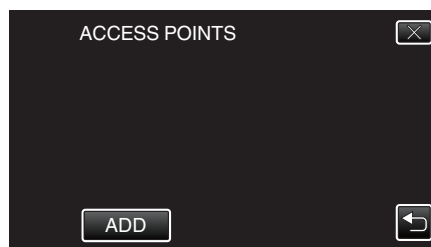

- 6 Tap "WPS PIN".
(Operation on this camera)

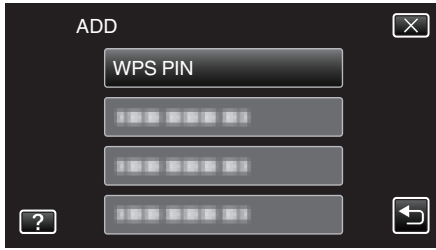

- The PIN code appears.

- 7 Enter the PIN code displayed on the camera to the access point (wireless LAN router).
 - For details on how to enter the PIN code, refer to the instruction manual of the device in use.

- 8 Tap "START".
(Operation on this camera)



- Tap "START" after entering PIN code to the wireless LAN router. (Connection cannot be established if "START" is tapped before entering the code.)

- 9 After registration is complete, tap "OK" on the camera's screen.
(Operation on this camera)

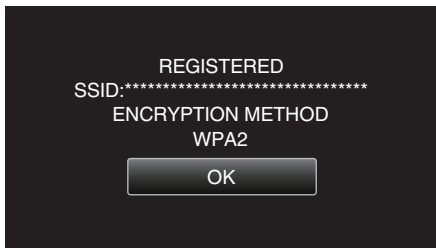

Editing LAN Settings of Access Points (Wireless LAN Router)

Change accordingly such as when you want to fix the IP address for the camera.

- 1 Tap "MENU".
(Operation on this camera)

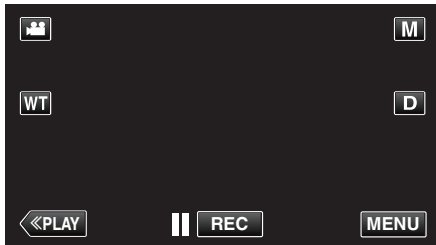

- The shortcut menu appears.

- 2 Tap "Wi-Fi" (Wi-Fi icon) in the shortcut menu.
(Operation on this camera)

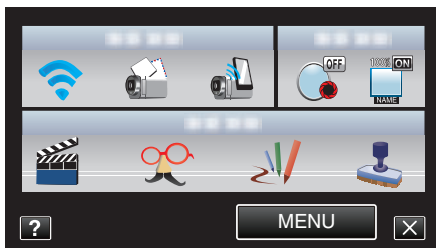

- 3 Tap "NETWORK SETTINGS".
(Operation on this camera)

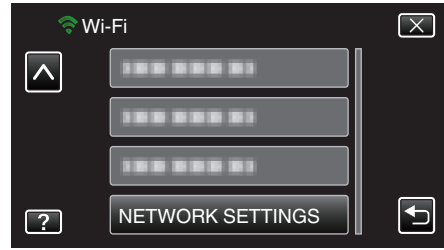

- 4 Tap "ACCESS POINTS".
(Operation on this camera)

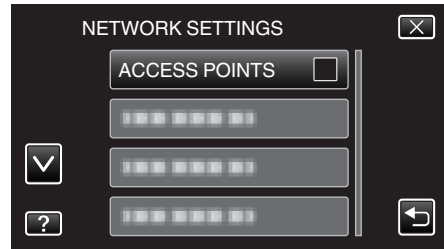

- 5 Tap "UPDATE".
(Operation on this camera)

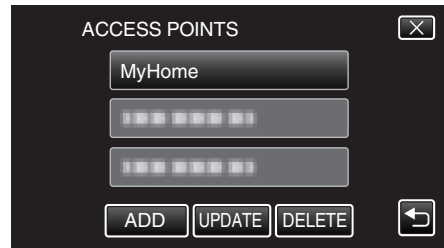

- Tap ^ or v to select an item to edit or delete.
- To change connection to another access point, tap on the desired access point.

- 6 Perform the LAN settings. (when "DHCP" is set to "OFF")
(Operation on this camera)

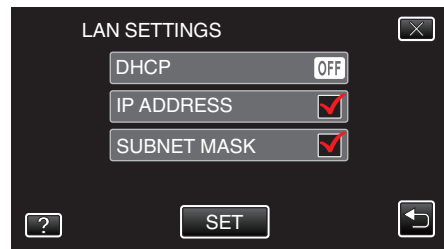

- After setting, tap "SET".
- LAN settings comprise of the following items.

DHCP	ON: Obtains IP address from the DHCP server automatically. OFF: Settings of "IP ADDRESS", "SUBNET MASK", "DEFAULT GATEWAY", "PRIMARY DNS", and "SECONDARY DNS" are required.
IP ADDRESS	Enter the IP address.
SUBNET MASK	Enter the subnet mask.
DEFAULT GATEWAY	Enter the default gateway.
PRIMARY DNS / SECONDARY DNS	Enter the IP addresses of the primary and secondary DNS servers.

Setting the Password (DIRECT MONITORING)

Sets the password for direct monitoring. (8 to 32 characters)

- 1 Tap "MENU".
(Operation on this camera)

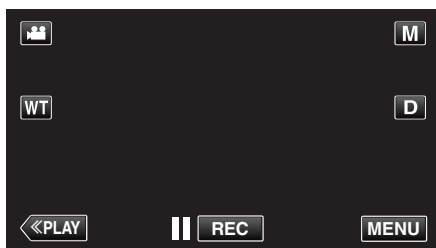

- The shortcut menu appears.

- 2 Tap "Wi-Fi" (📶) in the shortcut menu.
(Operation on this camera)

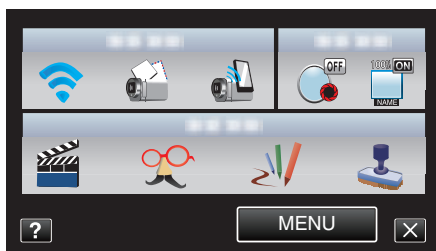

- 3 Tap "NETWORK SETTINGS".
(Operation on this camera)

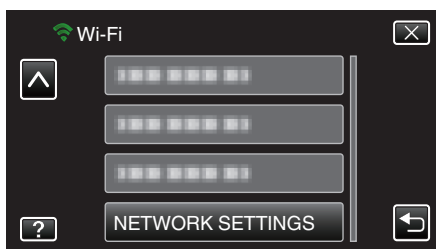

- 4 Tap "Wi-Fi DIRECT SETTING".
(Operation on this camera)

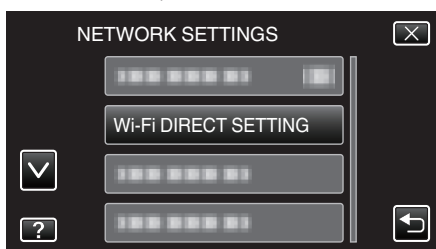

- 5 Tap "PASSWORD".
(Operation on this camera)



- 6 Enter the password.
(Operation on this camera)



- Tap on the on-screen keyboard to enter characters. The character changes with every tap.
- Tap "DELETE" to delete a character.
- Tap "CANCEL" to exit.
- Tap "A/a/1" to select character input type from upper case letter, lower case letter, and number.
- Tap ← or → to move one space to the left or right.
- After setting, tap "SET".

Setting the Enforced Group Owner (DIRECT MONITORING)

Sets whether to enforce authorization of the group owner.

- 1 Tap "MENU".
(Operation on this camera)

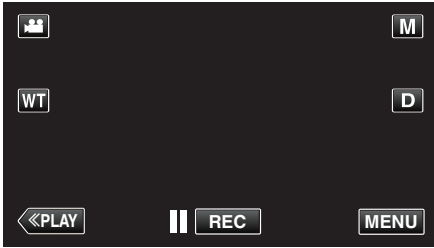

- The shortcut menu appears.

- 2 Tap "Wi-Fi" (📶) in the shortcut menu.
(Operation on this camera)

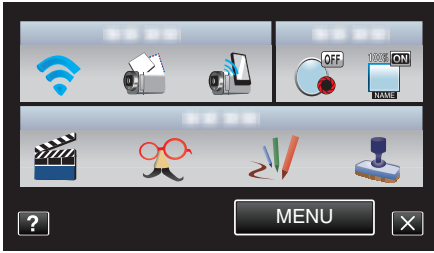

- 3 Tap "NETWORK SETTINGS".
(Operation on this camera)

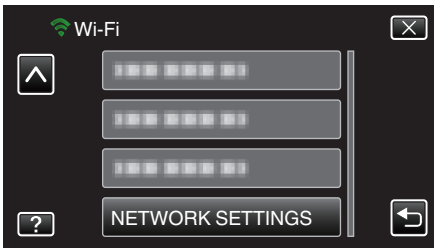

- 4 Tap "Wi-Fi DIRECT SETTING".
(Operation on this camera)

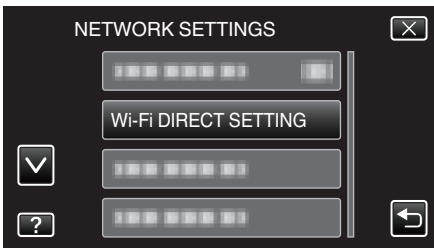

- 5 Tap "ENFORCED GROUP OWNER".
(Operation on this camera)



- Tap "ON" or "OFF".
- It is recommended to select "ON" usually.
If connection to devices that support Wi-Fi Direct fails, set to "OFF".
- After setting, tap "SET".

Memo :

- When set to "OFF", connection to devices that do not support Wi-Fi Direct will be disabled.

Checking the MAC Address of this Camera

Displays the MAC address of the camera.

- 1 Tap "MENU".
(Operation on this camera)

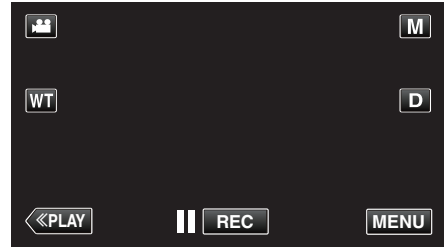

- The shortcut menu appears.

- 2 Tap "Wi-Fi" (📶) in the shortcut menu.
(Operation on this camera)

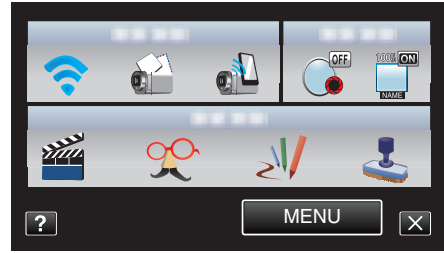

- 3 Tap "NETWORK SETTINGS".
(Operation on this camera)

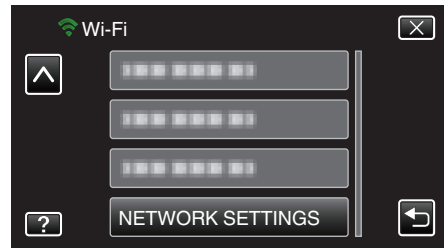

- 4 Tap "MAC ADDRESS".
(Operation on this camera)

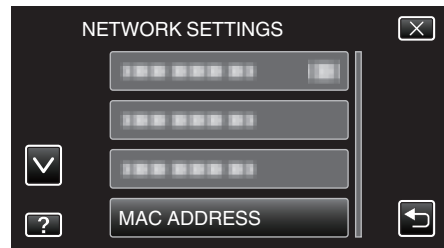

- The MAC address of the camera appears.
(The above shows the MAC address when connected to an access point, while the below shows the address during direct connection.)
- After setting, tap "SET".

Protecting the Network Settings with a Password

Sets a password to lock and protect the network settings.

- 1 Tap "MENU".
(Operation on this camera)

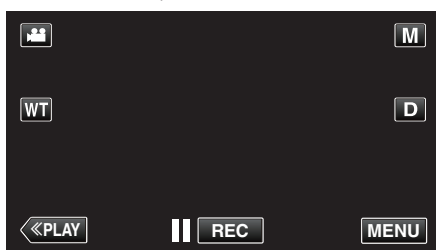

- The shortcut menu appears.

- 2 Tap "Wi-Fi" (📶) in the shortcut menu.
(Operation on this camera)

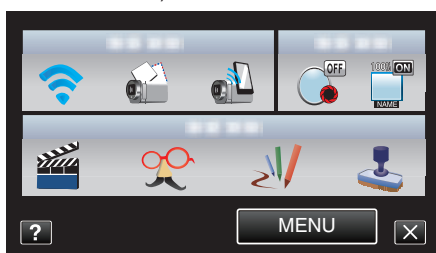

- 3 Tap "NETWORK SETTINGS".
(Operation on this camera)

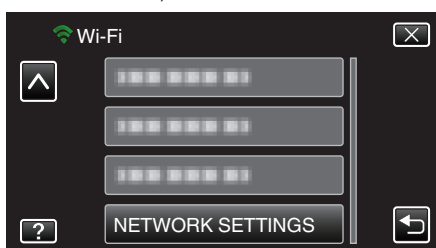

- 4 Tap "LOCK SETTINGS".
(Operation on this camera)

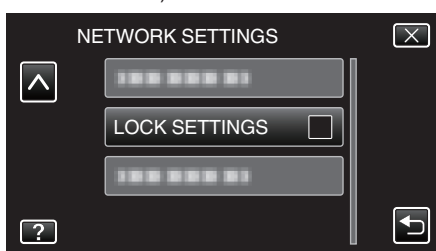

- 5 Enter the password.
(Operation on this camera)

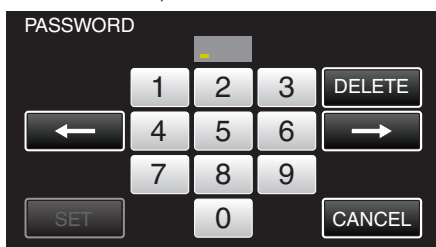

- Tap on the on-screen keyboard to enter characters. The character changes with every tap.
- Tap "DELETE" to delete a character.
- Tap "CANCEL" to exit.
- Tap ← or → to move one space to the left or right.
- After setting, tap "SET".

Initializing the Network Settings

Returns the network settings to their default values.

- 1 Tap "MENU".
(Operation on this camera)

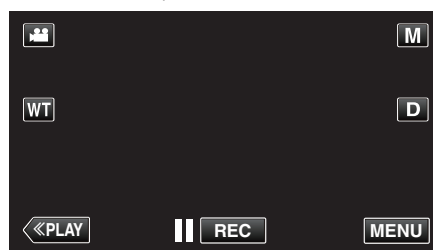

- The shortcut menu appears.

- 2 Tap "Wi-Fi" (📶) in the shortcut menu.
(Operation on this camera)



- 3 Tap "NETWORK SETTINGS".
(Operation on this camera)

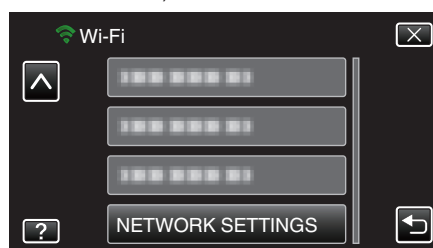

- 4 Tap "INITIALIZATION".
(Operation on this camera)

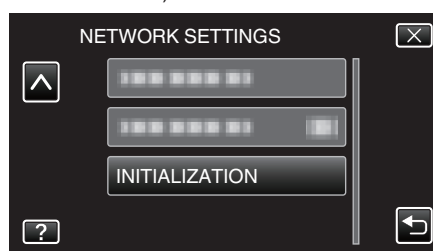

- 5 Tap "YES".
(Operation on this camera)

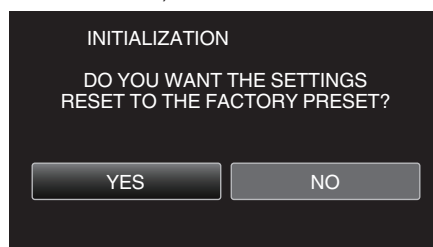

- To cancel, tap "NO".
- When "YES" is tapped, the network settings return to their default values.

Using Smartphone Applications

By using smartphone applications, you can connect to the camera and make use of the Wi-Fi function.

Installing Smartphone Applications

Android Smartphone

- 1 Tap [Market] on the application list.
- 2 Search for the “Everio Sync.” application.
- 3 Tap on the “Everio Sync.” application.
 - The detailed information of the application is displayed.
- 4 Tap [Download].
 - For applications that access data or functions of this unit, a screen that shows the data or functions that will be used is displayed.
- 5 Confirm the content and tap [Agree and Download].
 - Downloading starts.

Deleting the Application

- 1 Tap [Market] on the application list.
- 2 Press the menu button and tap [My apps].
- A list of previously downloaded applications is displayed.
- 3 Tap on the “Everio Sync.” application.
- 4 Tap [Uninstall], then tap [OK].

Memo :

The specifications of Android Market™ are subject to changes without prior notice.

For operating details, refer to the help file of Android Market™.

iPhone/iPad/iPod touch

- 1 Tap [App Store] on the home screen.
- 2 Search for the “Everio Sync.” application.
- 3 Tap on the “Everio Sync.” application.
 - The detailed information of the application is displayed.
- 4 Tap [FREE]→[INSTALL].
 - Enter your password on the password entry screen.
 - Downloading starts.
 - The downloaded application will be added to the home screen automatically.

Deleting the Application

- 1 Press and hold the “Everio Sync.” application on the home screen.
- 2 Tap X to confirm the deletion.

Memo :

The specifications of App Store™ are subject to changes without prior notice.

For operating details, refer to the help file of App Store™.

Operating the Smartphone Applications

- Indications on the screen
- “Indications on the Screen” (☞ p. 44)
- Transferring videos
- “Transferring Videos” (☞ p. 45)
- Transferring still images
- “Transferring Still Images” (☞ p. 46)
- Changing the settings
- “Changing the Settings” (☞ p. 48)

Indications on the Screen

Android Smartphone

Recording Screen

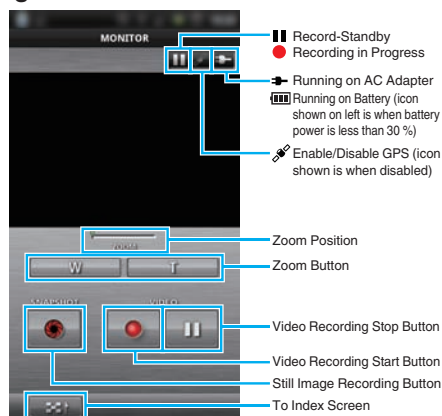

Video Index Screen

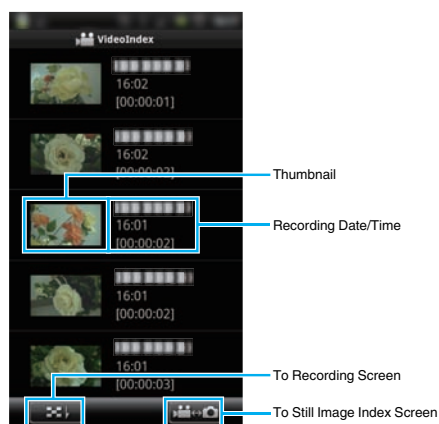

Still Image Index Screen

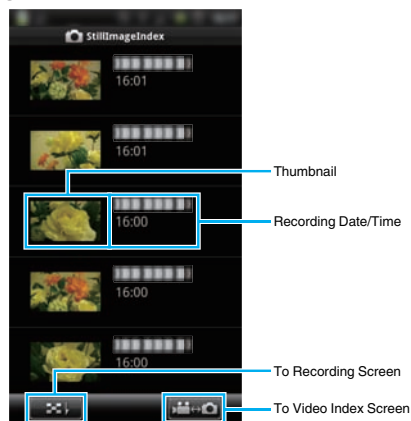

- To exit the application, press the “Return” button.

iPhone/iPad/iPod touch

Recording Screen

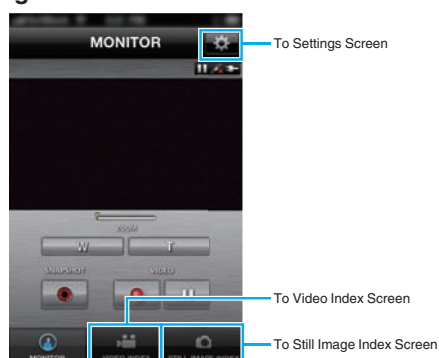

Caution :

- “Everio Sync.” for iPhone/iPad cannot be used when the iPhone/iPad is connected to the mobile phone network. To make use of this feature, connect to the camera or an access point via Wi-Fi.

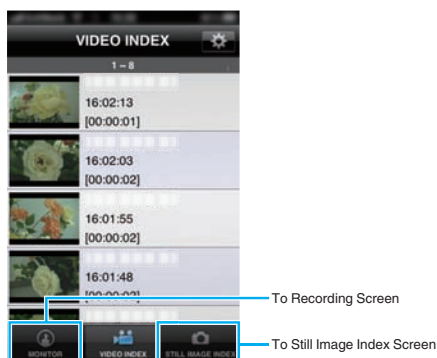
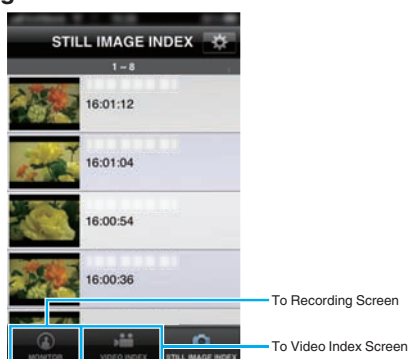
Video Index Screen**Still Image Index Screen**

- To exit the application, press the “Home” button.

Transferring Videos

You can transfer recorded videos to your smartphone.
Videos recorded in the 60p mode cannot be forwarded.

- The video to be forwarded is converted to the following format.
System: MP4
Video:
 - H.264/MPEG-4 AVC baseline profile codec
 - 640 x 360 resolution
 - 30p frame rate
 - 1 Mbps bit rate
 Audio:
 - Advanced Audio Coding (AAC) system
 - 48 kHz sampling rate
 - 16 bit
 - 2 channels

- 1 Start “Everio Sync.” on the smartphone.



- 2 Tap .

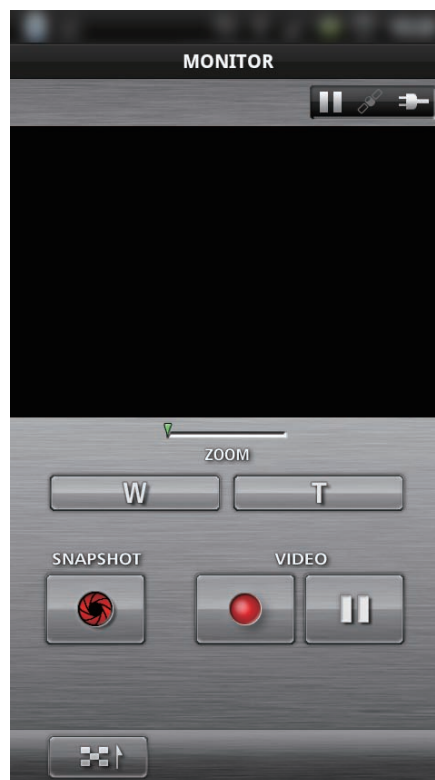

- 3 Tap on the thumbnail to transfer.

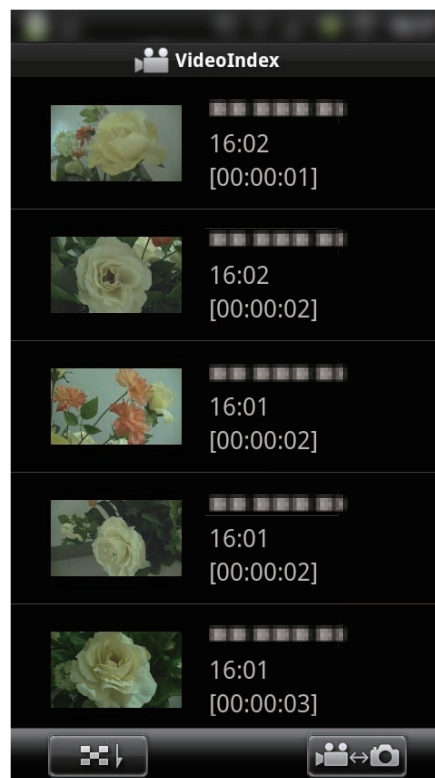

- 4 Tap on the start point (starting time) of the video to transfer.

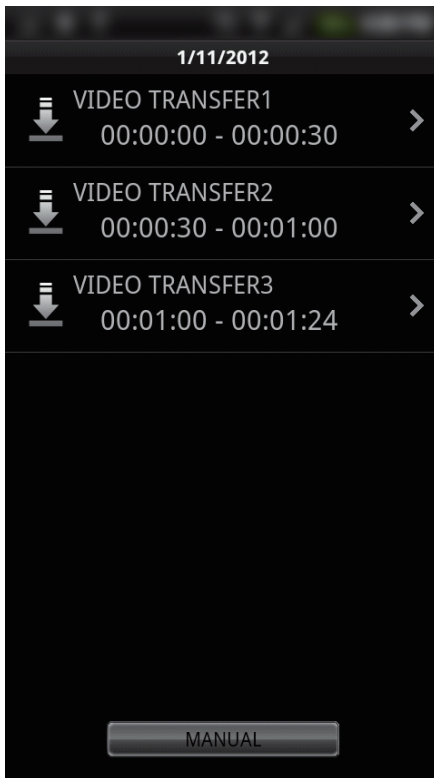

- The start point and length of video are displayed in the unit set in "VID LENGTH TO TRANS". (Display shown is when set to 30 seconds)
- To have a more detailed setting for the start point and length of video, tap "MANUAL".
- A progress status is displayed on the smartphone during preparation for the transfer and while transferring.
- To cancel the transfer, tap "CANCEL".

5 Set the start point and length of video, then tap "TRANSFER". (only when MANUAL is tapped in step 4)

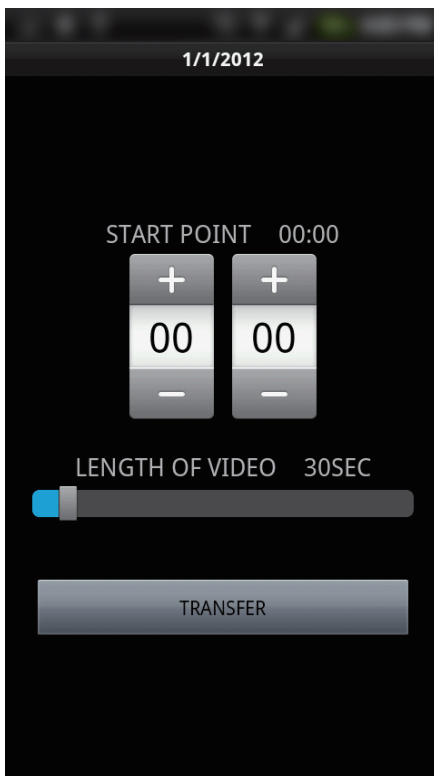

- A progress status is displayed on the smartphone during preparation for the transfer and while transferring.
- To cancel the transfer, tap "CANCEL".

6 After transferring is complete, tap "OK".

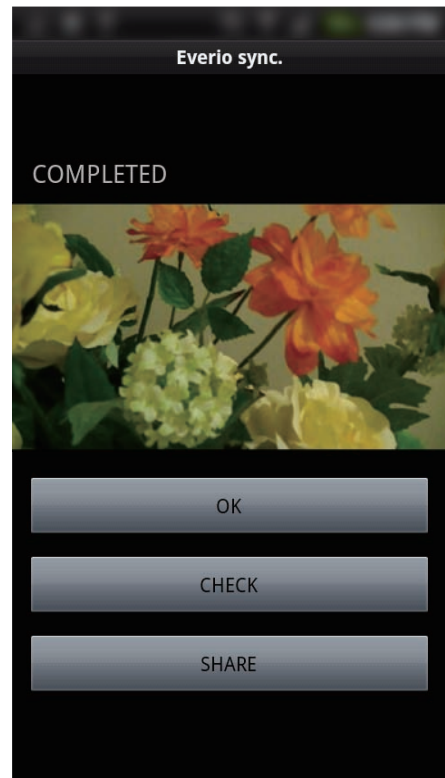

- To play back the video, tap "CHECK". (Android only)
- To upload (share) the video, tap "SHARE". (Android only)
Tap the desired service to start the uploading process.
To make use of a service, it is necessary to perform registration beforehand.

Transferring Still Images

You can transfer recorded still images to your smartphone.

1 Start "Everio Sync." on the smartphone.



2 (For Android) Tap .
(For iPhone) Tap .

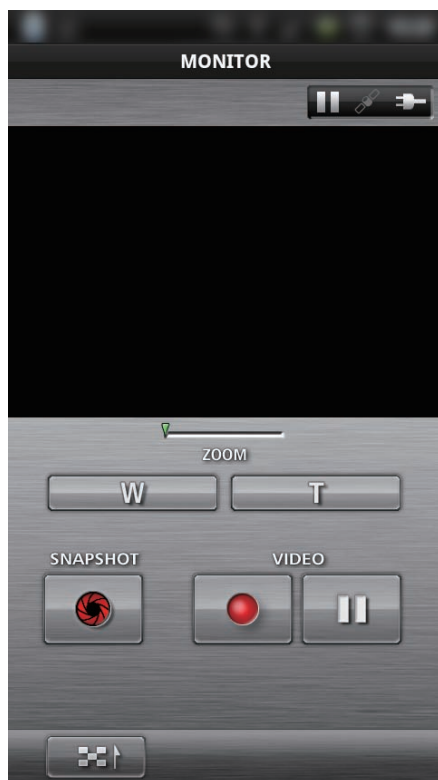

- 3 Tap ↔ . (Android only)

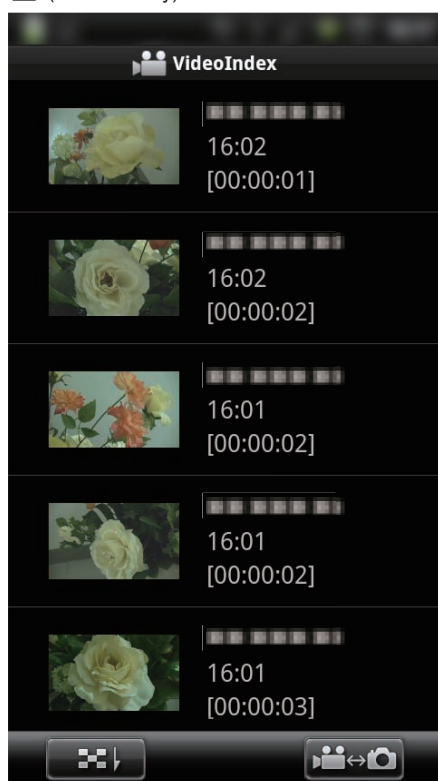

- 4 Tap on the thumbnail to transfer.

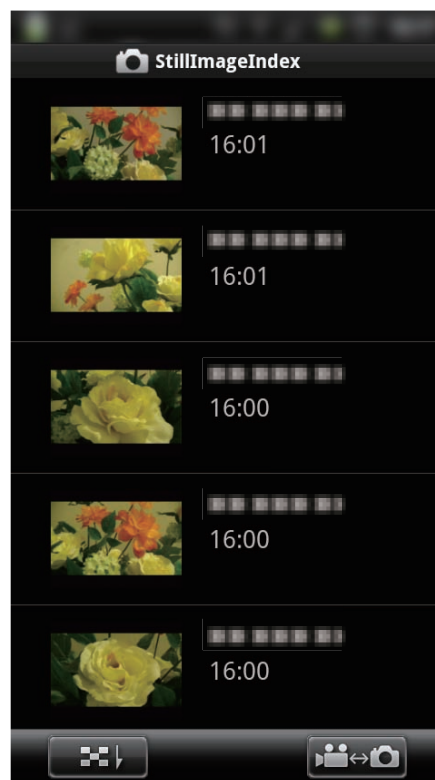

- A progress status is displayed on the smartphone during preparation for the transfer and while transferring.
 - To cancel the transfer, tap “CANCEL”.
- 5 After transferring is complete, tap “OK”.

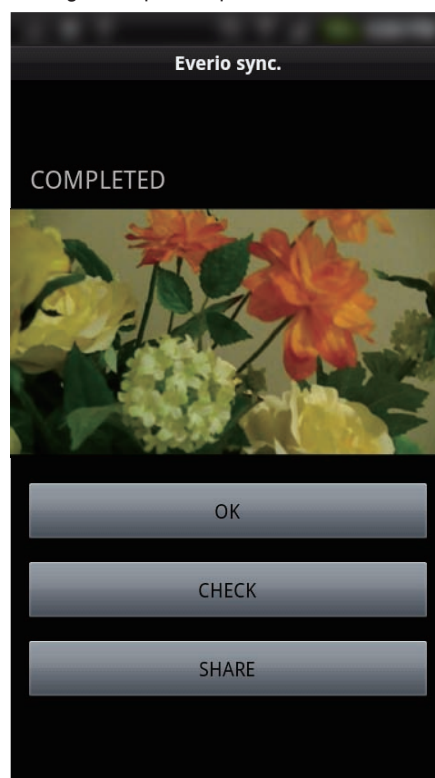

- To play back the still image, tap “CHECK”. (Android only)
- To upload (share) the still image, tap “SHARE”. (Android only)
Tap the desired service to start the uploading process.
To make use of a service, it is necessary to perform registration beforehand.

Changing the Settings

You can change the settings of the smartphone applications.

■ **Android Smartphone**

1 Press the MENU button.



2 Tap "SET".



3 Change the settings on the menu as desired.

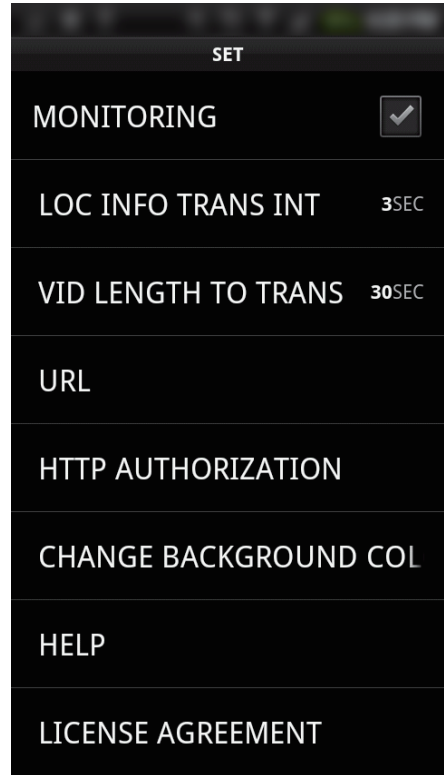

Item	Details
MONITORING	Turns monitoring of the recording screen on/off.
LOC INFO TRANS INT	Sets the time interval for sending location information.
VID LENGTH TO TRANS	Sets the length of video to transfer.
URL	Enter the URL when using outside monitoring.
HTTP AUTHORIZATION	Enter the required username and password when using outside monitoring. The username is "everio" (fixed) and the default password is "0000". (can be changed from camera)
CHANGE BACKGROUND COLOR	Changes the background.
HELP	Display how to use the Everio sync..
LICENSE AGREEMENT	Displays the license agreement of the smartphone application.

Memo :

- When connecting to outside monitoring, you will be prompted to enter the URL or HTTP authorization if they are not entered or entered incorrectly.

■ iPhone/iPad/iPod touch

1 Tap "⚙".



2 Change the settings on the menu as desired.



Item	Details
MONITORING	Turns monitoring of the recording screen on/off.
LOC INFO TRANS INT	Sets the time interval for sending location information.
CHANGE BACKGROUND COLOR	Changes the background.
LENGTH OF VIDEO	Sets the length of video to transfer.
URL	Enter the URL when using outside monitoring.
USERNAME	Enter the required username when using outside monitoring. The username is "everio". (fixed)
PASSWORD	Enter the required password when using outside monitoring. By default, the password is "0000". (can be changed from camera)
HELP	Display how to use the Everio sync..

Memo :

- When connecting to outside monitoring, you will be prompted to enter the URL, username, or password if they are not entered or entered incorrectly.

Using the Wi-Fi Function from a Web Browser

You can connect to the camera and make use of the Wi-Fi function from the web browser of a computer.

- Indications on the screen

“Indications on the Screen” (☞ p. 50)

- Changing the settings

“Making Camera Settings from a Web Browser” (☞ p. 52)

Indications on the Screen

■ Recording Screen

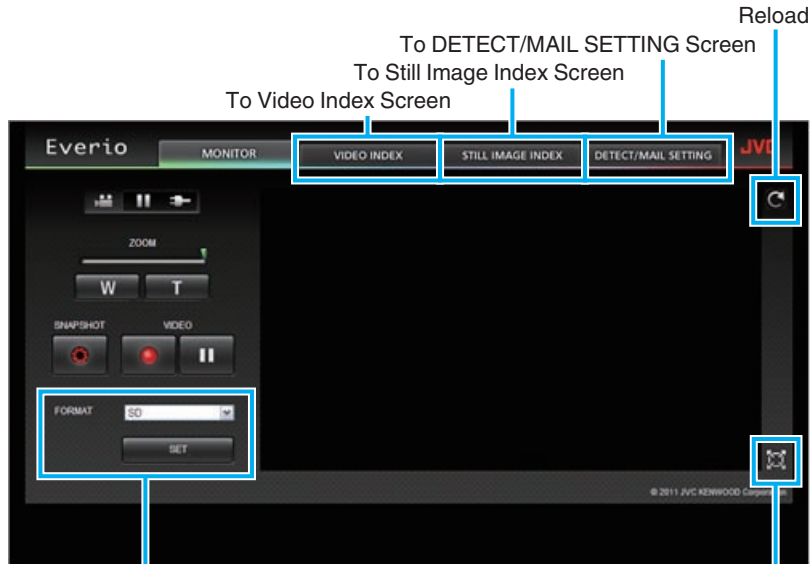

Stream Format Selection (click “SET” to apply) Select the video format when monitoring from a browser.

FORMAT	MotionJPEG	Full HD: 1920x1080 / MPEG-2 TS format
	Full HD	SD: 720x480 / MPEG-2 TS format
	SD	MotionJPEG: 640x360 / MotionJPEG format
	MotionJPEG	

Full Screen (press ESC or double left click to return)

Memo :

- The full screen button is not displayed when the stream format is MotionJPEG.

Caution :

- Features of the stream format are as follows:
 - Full HD/SD (MPEG-2 TS format)
 - Sound of the camera can be checked from the browser.
 - Recording and zoom operations cannot be performed from the browser.
 - MotionJPEG
 - Sound of the camera cannot be played back from the browser.
 - Recording and zoom operations can be performed from the browser.
- The monitor's image stops automatically after monitoring is performed continuously for 12 hours in Full HD or SD. (To resume, press the reload button)
- To use Full HD or SD, it is necessary to install Media Player 12 in advance.
- When the video recording quality is set to SSW/SEW on the camera, Full HD will not take effect even if selected.
- Lagging of the screen may be caused by the network speed or computer performance.
- If lagging is severe, reload the screen regularly. (It may take some time for the screen to be displayed after reloading.)
- For Full HD, make use of a computer with the following system requirements.
 - CPU Intel Core 2 Duo 2 GHz or higher
 - 2 GB memory or higher

Video Index Screen

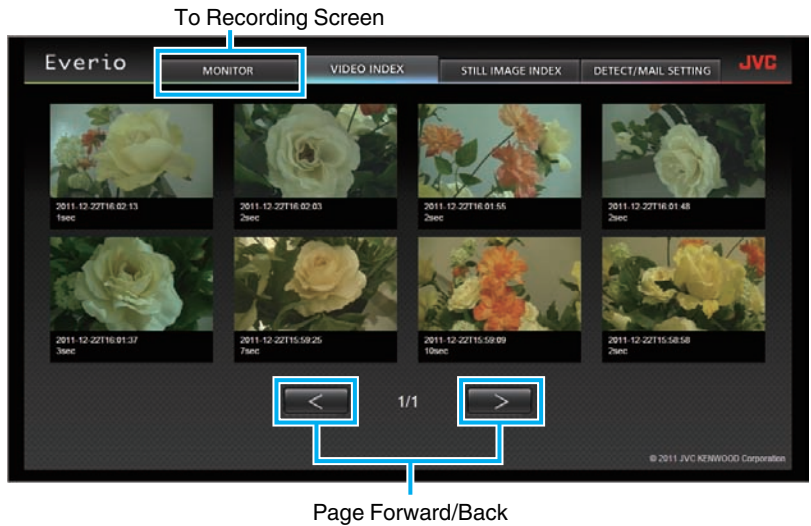

- To download a video, click on the thumbnail.

Still Image Index Screen



- To download a still image, click on the thumbnail.

DETECT/MAIL SETTING Screen

Notification mail settings such as detection method and recipient's e-mail address can be changed even when the camera is out of reach. Registered e-mail addresses of recipients in Everio (Up to 8)
 *A check mark appears on the selected address.

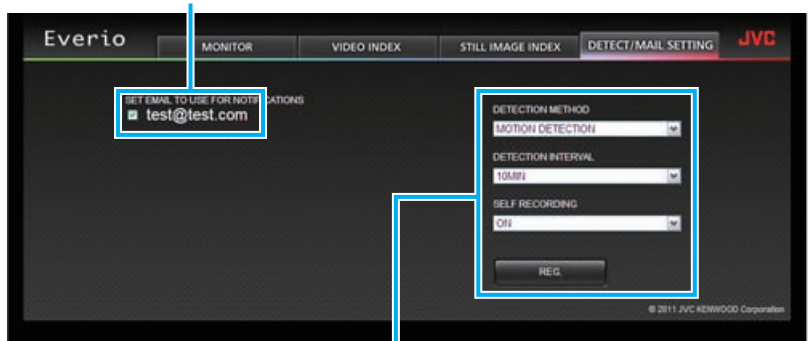

Notification Mail Settings

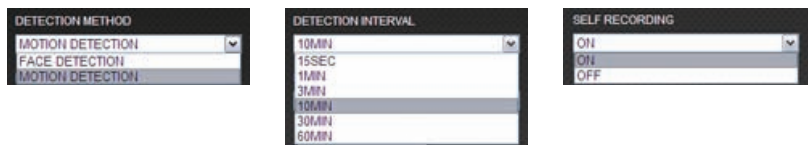

(click "REG." to apply)

Making Camera Settings from a Web Browser

You can change the camera settings from a web browser.

- 1 Tap "MENU".
(Operation on this camera)

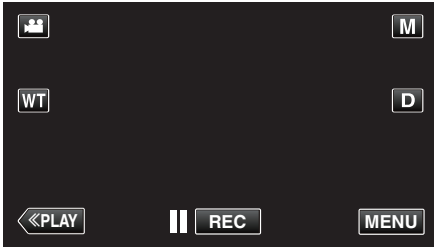

- The shortcut menu appears.

- 2 Tap "Wi-Fi" (Wi-Fi icon) in the shortcut menu.
(Operation on this camera)

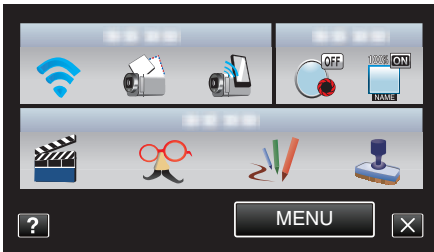

- 3 Tap "NETWORK SETTINGS".
(Operation on this camera)

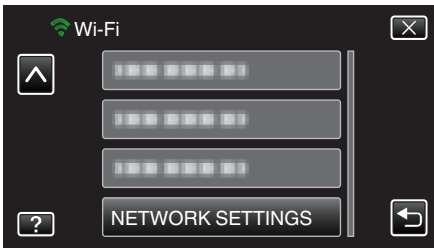

- 4 Tap "SET FROM WEB BROWSER".
(Operation on this camera)

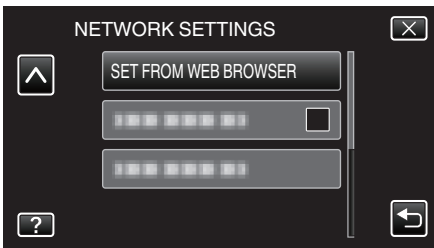

- 5 Check the SSID and PASS shown on the camera's screen, then register them on the computer to connect.
(Operation on this camera)

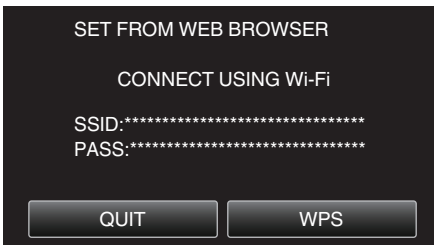

- When the computer is connected to the camera, a URL appears on the camera.

- 6 Check the URL shown on the camera's screen, then enter it on the Internet Explorer (web browser).
(Operation on this camera)

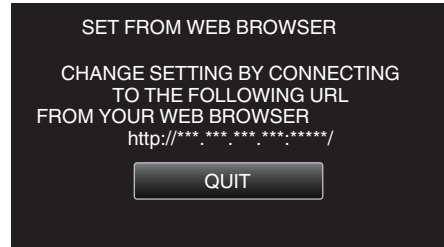

- To exit, tap "QUIT".

You can change the Wi-Fi function of the camera from a web browser.

"Adding/Changing/Deleting an Access Point" (p. 53)

"OUT MONITORING SET" (p. 54)

"Wi-Fi DIRECT SETTING" (p. 54)

"Mail Setting" (p. 54)

Adding/Changing/Deleting an Access Point

To search and add "ACCESS POINTS"

- 1 Click "Access Point".

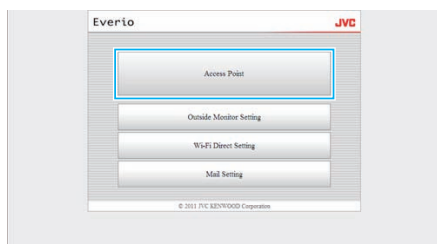

- 2 Click "SEARCH".



- 3 Click on the access point you want to add.



- Click "SEARCH AGAIN" to perform search for an access point again.

- 4 Enter the password, and click "REG.".

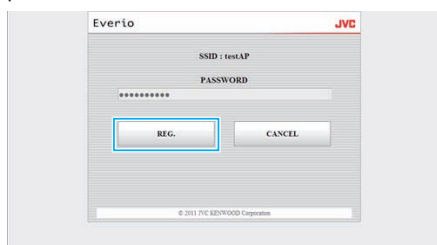

- Password entry is not required if the access point is security protected.

- 5 Click "OK".



To add "ACCESS POINTS" manually

- 1 Click "Access Point".

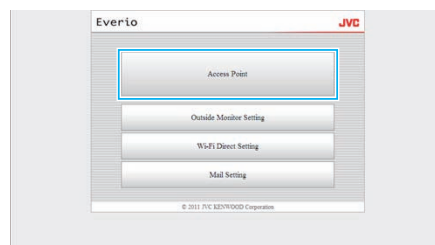

- 2 Click "ADD".

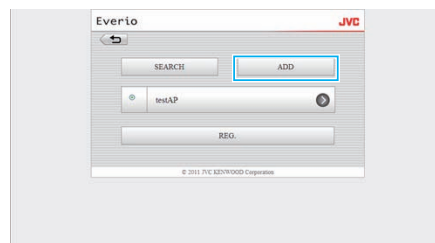

- 3 Enter "SSID", "TYPE OF SECURITY", and "PASSWORD", and click "REG.".



- To configure the LAN settings manually, set "DHCP" to OFF, and enter the necessary information manually.

- 4 Click "OK".

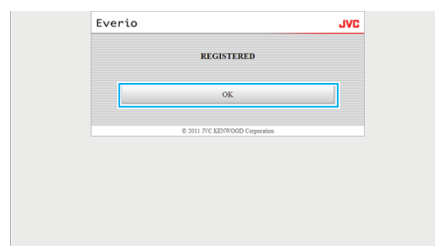

To change (or delete) an "ACCESS POINTS" registration

- 1 Click "Access Point".



- 2 Click on a registered access point.

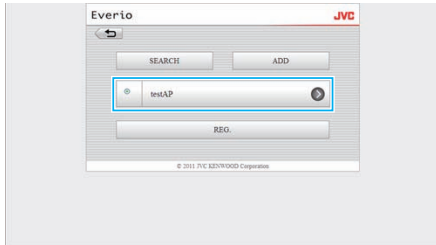

3 After changes are made, click "REG."

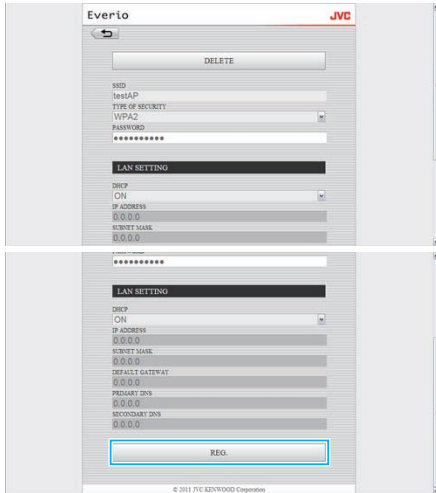

- Click "DELETE" on this screen to delete the registered access point.

4 Click "OK".



WI-FI DIRECT SETTING

To change "Wi-Fi DIRECT SETTING"

1 Click "Wi-Fi Direct Setting".

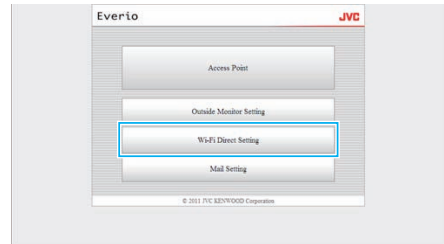

2 After changes are made, click "REG."

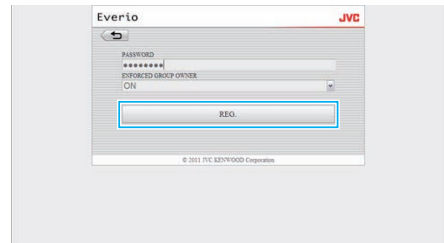

- Click "DELETE" on this screen to delete the registered access point.

3 Click "OK".



OUT MONITORING SET

To change "OUT MONITORING SET"

1 Click "Outside Monitor Setting".



2 After changes are made, click "REG."



- Click "DELETE" on this screen to delete the registered access point.

3 Click "OK".

Mail Setting

To change "SENDER'S EMAIL" settings

1 Click "Mail Setting".

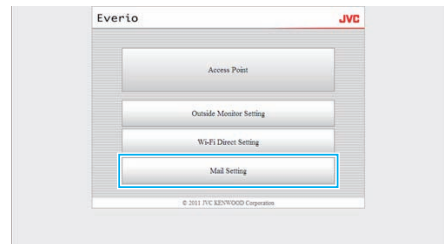

2 Click "SENDER'S EMAIL".



- 3 Enter the necessary information, and click “REG.”.



- 4 Click “OK”.



To add a “RECIPIENT'S EMAIL”

- 1 Click “Mail Setting”.

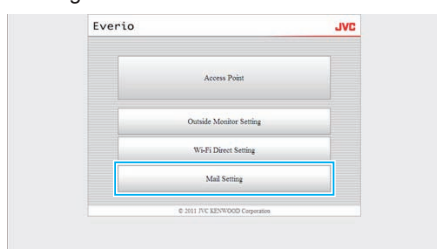

- 2 Click “RECIPIENT'S EMAIL”.

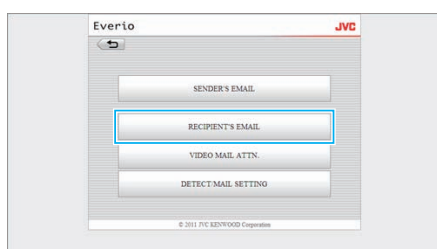

- 3 Click “ADD”.

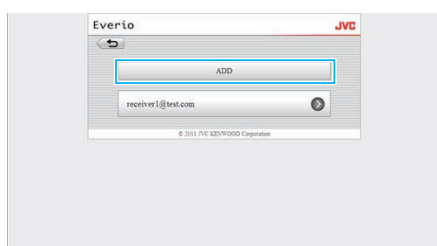

- 4 Enter the mail address, and click “REG.”.

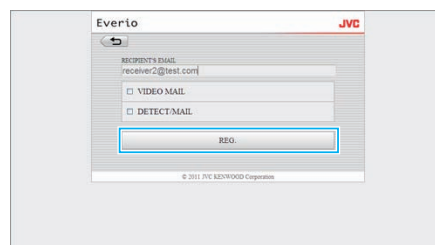

- Select the checkbox for “VIDEO MAIL” and “DETECT/MAIL” to set the address as the recipient.

- 5 Click “OK”.

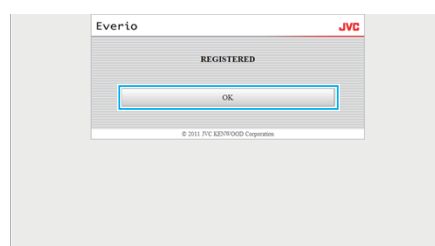

To change or delete a “RECIPIENT'S EMAIL”

- 1 Click “Mail Setting”.

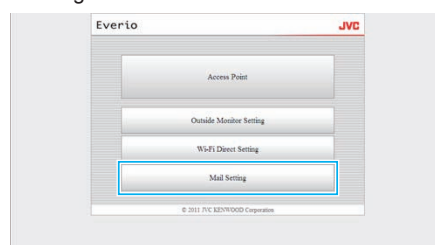

- 2 Click “RECIPIENT'S EMAIL”.



- 3 Click on the mail address you want to change.

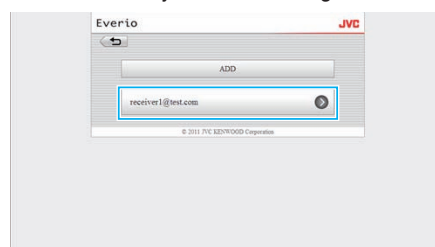

- 4 After changes are made, click “REG.”.

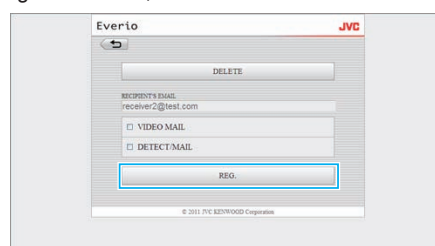

- Click “DELETE” on this screen to delete the registered address.

- 5 Click “OK”.

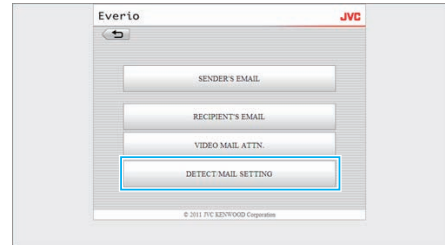

To change "VIDEO MAIL ATTN." settings

1 Click "Mail Setting".

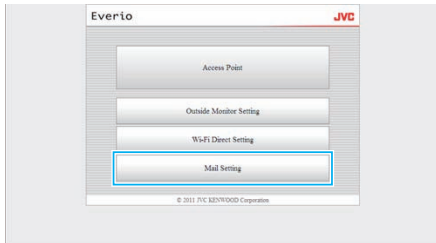

2 Click "VIDEO MAIL ATTN.".



3 After changes are made, click "REG.".

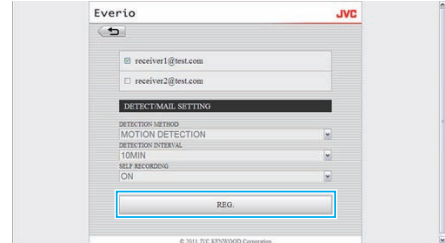

4 Click "OK".

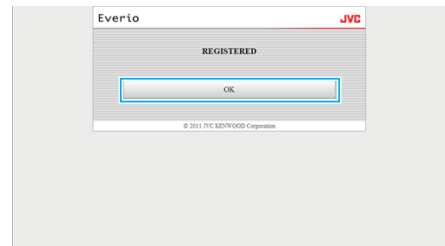

3 After changes are made, click "REG.".

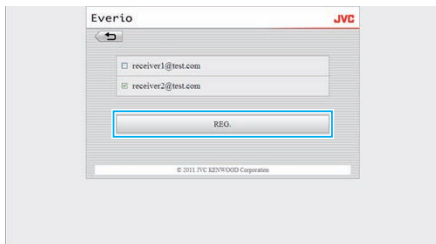

4 Click "OK".



To change "DETECT/MAIL SETTING"

1 Click "Mail Setting".



2 Click "DETECT/MAIL SETTING".

Troubleshooting

Direct Monitoring

Trouble	Action
Unable to connect to camera. (URL required)	<ul style="list-style-type: none"> • Check whether the Wi-Fi connection is established successfully. • Check whether Wi-Fi is connected to "DIRECT-***EVERIO". • Check whether the smartphone (or computer) is connected to the camera. • Try again after powering off and on the camera and the terminal (smartphone or computer).
Operations from this unit do not work when direct monitoring is in use.	<ul style="list-style-type: none"> • Operations cannot be performed from this unit when direct monitoring is in use. Tap "CAMERA OPERATION" on the screen to enable operations from this unit. When operations from this unit are enabled, operations from the smartphone (or computer) do not work.
Recording stops when the Android / iPhone application or web browser is closed.	<ul style="list-style-type: none"> • When the Android / iPhone application or web browser is closed during recording, the camera gets disconnected and recording stops.
Unable to browse internet on the computer when it is connected to the camera.	<ul style="list-style-type: none"> • The camera operates as an access point during direct monitoring. Most computers (or smartphones) cannot be connected to multiple access points at the same time. As such, internet browsing becomes temporarily unavailable if the computer (or smartphone) has been connected to the internet via wireless LAN. • Reconnect the computer to the wireless LAN router that is usually used for internet connection. If the computer connects to the camera unintentionally, remove the camera connection from the computer. (The registered name is "DIRECT-***EVERIO".) • Stop direct monitoring on the camera.
Video or audio is interrupted or delayed	<ul style="list-style-type: none"> • If the network speed is slow, videos and audio sound may be interrupted, or delay may become significant. • (For web browser) Lagging may become significant due to the performance of the computer. If the stream format is set to "Full HD", change to "SD" or "Motion-JPEG" and try again. "Wi-Fi Specifications" (p. 60) • (For web browser) If lagging is severe, reload the screen regularly. • (For smartphone) Try to change the place and time to locate an environment with good signal strength.
The unit turns off automatically.	<ul style="list-style-type: none"> • To prevent the situation of forgetting to turn off the power, this unit will turn off automatically after 10 days of continuous usage.
Unable to set focus.	<ul style="list-style-type: none"> • When not monitoring from a smartphone (or computer), the focus of the camera is fixed. • Even when monitoring from a smartphone (or computer), the focus of the camera will be fixed if not operated for more than 3 hours. (Focus works again when the camera is operated.)
Connection gets disconnected, or a "UNABLE TO CONNECT" message is displayed	<ul style="list-style-type: none"> • Establish connection again at a place with good signal strength. Transmission speed may drop, or connection may fail if the devices are placed too far away from each other, when there are objects in between, or when microwave ovens or other wireless devices are in use. • If connection cannot be established again, restart the terminal (smartphone or computer). • If the camera is too far away from the smartphone (or computer), connection for direct monitoring may be difficult to be established depending on the environment. In this case, connect via an access point (wireless LAN router).

Access Point (Wireless LAN Router)

Trouble	Action
Unable to find an access point (wireless LAN router).	<ul style="list-style-type: none"> • Check whether the distance from the access point (wireless LAN router) is too far, or whether there are shielding materials in between. • If the access point (wireless LAN router) in use goes into the SSID stealth mode, perform manual registration or disable the stealth mode temporarily before registering. • In an environment with multiple access points, you may not be able to find the desired access point through searching. In this case, add the access point manually.
Unable to connect to access point (wireless LAN router).	<ul style="list-style-type: none"> • Check that the password is correct. • For manual connection, check that the SSID or authentication method is correct.
Unsure of which access point (wireless LAN router) to use.	<ul style="list-style-type: none"> • If the settings of the access point (wireless LAN router) have never been changed from their default values, check the following. <ul style="list-style-type: none"> - Check whether an adhesive label indicating the initial settings is attached to the body of the access point (wireless LAN router). - Check for the default settings in the instruction manual of the access point (wireless LAN router).

Using Wi-Fi

Unsure of password for the access point (wireless LAN router).	Refer to the instruction manual of the access point (wireless LAN router) in use.
Unable to connect via Wi-Fi Protected Setup (WPS).	<ul style="list-style-type: none"> • Simple connection methods other than WPS are not supported. Conduct a search for the access point to connect. • Turn off the power of the camera, then try again.

Outside Monitoring (Connection in the House)

Trouble	Action
Unable to connect to camera. (URL required)	<ul style="list-style-type: none"> • Check whether the Wi-Fi connection is established successfully. • Check to ensure that the camera and the terminal (smartphone or computer) are connected to the same access point. • Try again after powering off and on the camera and the terminal (smartphone or computer).
Unsure of URL to access from a web browser.	<ul style="list-style-type: none"> • After outside monitoring is started, tap "CAMERA NETWORK INFO." shown on the camera's screen. Enter the address as shown in "URL(LAN):" into the web browser to access it.
No image and sound when accessing from a web browser.	<ul style="list-style-type: none"> • If you have installed third-party video players, images and sounds may not be played back properly. • If the stream format is set to "Motion-JPEG" when transferring to the web browser, no sound will be output from the browser. • If recording of the video is in progress, no sound will be output from the browser.
Unable to access the entered URL. (cannot be found)	<ul style="list-style-type: none"> • Check that the camera is properly connected to an access point (wireless LAN router). (Wi-Fi icon appears on the camera's screen.) • Check that the computer is properly connected to an access point (wireless LAN router). Connection should be possible if it is connected to the internet. • Check that the URL is correct.
Unable to access the entered URL. (password required)	<ul style="list-style-type: none"> • Enter your username and password. The username is "everio" (fixed) and the default password is "0000" (can be changed).
Operations from this unit do not work when outside monitoring is in use.	<ul style="list-style-type: none"> • Operations cannot be performed from this unit when outside monitoring is in use. Operate from the Android / iPhone application or web browser.
Recording stops when the Android / iPhone application or web browser is closed.	<ul style="list-style-type: none"> • When the Android / iPhone application or web browser is closed during recording, the camera gets disconnected and recording stops.
Video or audio is interrupted or delayed	<ul style="list-style-type: none"> • If the network speed is slow, videos and audio sound may be interrupted, or delay may become significant. • (For web browser) Lagging may become significant due to the performance of the computer. If the stream format is set to "Full HD", change to "SD" or "Motion-JPEG" and try again. <p>"Wi-Fi Specifications" (p. 60)</p> <ul style="list-style-type: none"> • (For web browser) If lagging is severe, reload the screen regularly. • (For smartphone) Try to change the place and time to locate an environment with good signal strength.
The unit turns off automatically.	<ul style="list-style-type: none"> • To prevent the situation of forgetting to turn off the power, this unit will turn off automatically after 10 days of continuous usage.
Unable to set focus.	<ul style="list-style-type: none"> • When not monitoring from a smartphone (or computer), the focus of the camera is fixed. • Even when monitoring from a smartphone (or computer), the focus of the camera will be fixed if not operated for more than 3 hours. (Focus works again when the camera is operated.)
Connection gets disconnected, or a "UNABLE TO CONNECT" message is displayed	<ul style="list-style-type: none"> • Establish connection again at a place with good signal strength. Transmission speed may drop, or connection may fail if the devices are placed too far away from each other, when there are objects in between, or when microwave ovens or other wireless devices are in use. • If connection cannot be established again, restart the terminal (smartphone or computer).
Screen does not refresh or remains black	<ul style="list-style-type: none"> • Check if the camera and the access point are properly connected. Images cannot be detected on the terminal (smartphone or computer) if the camera is disconnected from the access point halfway through.

Outside Monitoring (Connection from the Internet)

Trouble	Action
Unsure of URL to access from a web browser.	<ul style="list-style-type: none"> After outside monitoring is started, tap "CAMERA NETWORK INFO." shown on the camera's screen. Enter the address as shown in "URL(WAN):" into the web browser to access it.
The URL (WAN) does not appear in the network information.	<ul style="list-style-type: none"> The URL (WAN) will not appear if dynamic DNS is not set on the camera. To set dynamic DNS, perform the following steps. <ol style="list-style-type: none"> Obtain an account with JVC dynamic DNS service using your computer. (URL?) Log in to JVC DNS and obtain the dynamic DNS service. (How?) Set the obtained dynamic DNS username and password on the camera. *Only the JVC dynamic DNS service can be set on this camera.
Unable to access the entered URL. (cannot be found)	<ul style="list-style-type: none"> This function cannot be used in an environment with two or more routers. Check that the dynamic DNS username and password are correct. The router in use is not compatible with UPnP, or UPnP is turned off. Check the instruction manual of the router in use, and turn on UPnP. The "UPnP" of the camera is set to "OFF". (By default, it is set to "ON".) Set "UPnP" to "ON". Depending on the terms of service with your provider, it may not be possible to obtain a global IP address. "Confirming global IP address" (p. 21) Check whether a terminal that uses port 80, such as web servers, has been set in the network. If it is set, change the port number of the terminal. When a specific terminal has been set to use port 80 on the router, change the setting such that port 80 can be used by the camera. Try again after powering off and on the camera and the terminal (smartphone or computer).
Video or audio is interrupted or delayed	<ul style="list-style-type: none"> If the network speed is slow, videos and audio sound may be interrupted, or delay may become significant. (For web browser) Lagging may become significant due to the performance of the computer. If the stream format is set to "Full HD", change to "SD" or "Motion-JPEG" and try again. "Wi-Fi Specifications" (p. 60) (For web browser) If lagging is severe, reload the screen regularly. (For smartphone) Try to change the place and time to locate an environment with good signal strength.
The unit turns off automatically.	<ul style="list-style-type: none"> To prevent the situation of forgetting to turn off the power, this unit will turn off automatically after 10 days of continuous usage.
Unable to set focus.	<ul style="list-style-type: none"> When not monitoring from a smartphone (or computer), the focus of the camera is fixed. Even when monitoring from a smartphone (or computer), the focus of the camera will be fixed if not operated for more than 3 hours. (Focus works again when the camera is operated.)
Connection gets disconnected, or a "UNABLE TO CONNECT" message is displayed	<ul style="list-style-type: none"> Establish connection again at a place with good signal strength. Transmission speed may drop, or connection may fail if the devices are placed too far away from each other, when there are objects in between, or when microwave ovens or other wireless devices are in use. If connection cannot be established again, restart the terminal (smartphone or computer).
Screen does not refresh or remains black	<ul style="list-style-type: none"> Check if the camera and the access point are properly connected. Images cannot be detected on the terminal (smartphone or computer) if the camera is disconnected from the access point halfway through.
[XUPnP] is displayed.	<p>This appears when UPnP has failed.</p> <ul style="list-style-type: none"> Check whether the wireless LAN router in use is compatible with UPnP. (Refer to the instruction manual of the wireless LAN router in use, or consult the manufacturer of the router.) When the wireless LAN router in use is compatible with UPnP, turn on the UPnP function. If the icon does not disappear even when the UPnP function is enabled, turn off and on the power of the wireless LAN router in use as well as the camera, then try again.
Unable to connect although [XUPnP] is displayed.	<ul style="list-style-type: none"> When "UPnP" is set to "OFF", [XUPnP] will not appear. Set "UPnP" to "ON". When port 80 has been used by other devices via UPnP, connection cannot be established. Reconnect the camera.

E-mail (Notification Mail, Video Mail)

Trouble	Action
Unable to send e-mails.	<ul style="list-style-type: none"> • Check that the settings of the e-mail server are correct. • Check that the settings of the sender's e-mail address are correct. • Check that the username and password are correct. • If you are using an e-mail service that is not from your provider, it may be necessary to change the SMTP settings. • Some free e-mail services from web browsers or e-mail softwares (SMTP) may have default SMTP settings that do not allow e-mails to be sent. Change the SMTP settings to allow sending of e-mails before use.
Sent e-mails are not received.	<ul style="list-style-type: none"> • Check whether notifications indicating errors have been sent to the sender's e-mail address. (Make use of a computer or similar devices as it is not possible to check from the camera.) - If no notifications are received: Refer to "Unable to send e-mails." and adjust the settings accordingly. - If notifications are received: Check the content of the notification. <p>*Note: Do not continue sending e-mails with the same settings if you receive error notifications. Depending on the provider, you may be marked as a sender of spam (junk mail).</p>
Unable to attach images to e-mails.	<ul style="list-style-type: none"> • Depending on the provider, some attached files may be deleted. Make use of other free e-mail services.
The unit turns off automatically.	<ul style="list-style-type: none"> • To prevent the situation of forgetting to turn off the power, this unit will turn off automatically after 10 days of continuous usage.
Unable to set focus.	<p>(For DETECT/MAIL SETTING)</p> <ul style="list-style-type: none"> • While on standby for notification mails, the focus is fixed. Perform the camera settings first, then enable notification mails. Focus may not be set correctly if the notification mails start before camera settings are made. In this case, disable notification mails temporarily, then enable it again.

Vide/Still Image Transmission

Trouble	Action
Unable to transfer videos and still images to smartphone (or computer).	<ul style="list-style-type: none"> • Check the amount of remaining free space in the destination medium (smartphone or computer).

Wi-Fi Specifications

Wi-Fi Specifications

Item	Details
Wireless LAN Standard	IEEE802.11b/g/n (2.4GHz band)

DIRECT MONITORING / OUTSIDE MONITORING

■ When Using Everio sync.

Item	Details
Supported Terminals	<p>iPhone/iPad/iPod touch: iOS 4.3.5 or later Android: Android 2.1 or later</p> <ul style="list-style-type: none"> • There is no guarantee that the operations will work with all terminals. • "Everio Sync." for iPhone/iPad cannot be used when the iPhone/iPad is connected to the mobile phone network. To make use of this feature, connect to the camera or an access point via Wi-Fi. • A network environment with a minimum line speed of about 5.3 Mbps is recommended for both the camera sending the data and the smartphone terminal receiving the data. If the network speed is too low, video images may appear jumpy, or audio sound may be interrupted or delayed.
Monitor Screen	<p>Video: JPEG 640x360 max. 15 fps Audio: linear PCM 8kHz 16 bits 1ch</p>
Video Transmission	<p>Video: MP4-compliant H.264 Baseline Profile 640x360 30p Audio: AAC 48kHz 16 bits 2ch</p>
Still Image Transmission	JPEG format

■ When Using Web Browser

Item	Details
Operating Environment	<p>Windows 7: Internet Explorer 9 or a later version, and Windows Media Player 12 or a later version are installed</p> <ul style="list-style-type: none"> • For Full HD, make use of a computer with the following system requirements. <ul style="list-style-type: none"> - CPU: Intel Core 2 Duo 2 GHz or higher - Memory: 2 GB or higher • A network environment with the following line speed is recommended for both the camera sending the data and the PC receiving the data. <ul style="list-style-type: none"> - MotionJPEG: approx. 1.7 Mbps or higher - Full HD: approx. 10 Mbps or higher - SD: approx. 3 Mbps or higher <p>If the network speed is too low, video images may appear jumpy, or audio sound may be interrupted or delayed.</p>
Monitor Screen	<ul style="list-style-type: none"> • MotionJPEG Video: JPEG 640x360 max. 5 fps Audio: nil • Full HD Video: MPEG-2 TS compliant H.264 High Profile 1920x1080 60i Audio: AAC 48kHz 16 bits 2ch • SD Video: MPEG-2 TS compliant H.264 Main Profile 720x480 60i Audio: AAC 48kHz 16 bits 2ch
Video Transmission	MPEG-2TS format (no conversion)
Still Image Transmission	JPEG format (no conversion)

VIDEO MAIL







Item	Details
Video	MP4-compliant H.264 Baseline Profile 640x360 30p
Audio	AAC 48kHz 16 bits 2ch
Time	Max. 15 seconds

RECIPIENT'S EMAIL

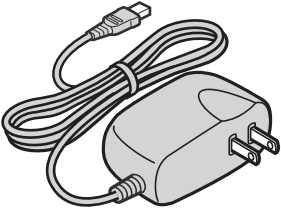
Item	Details
Still Image Transmission	JPEG 640x360

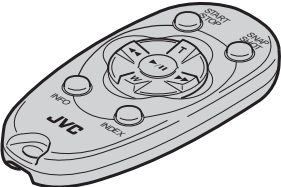
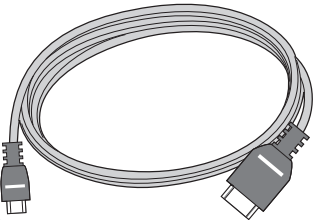
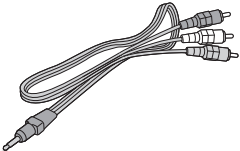
Verifying the Accessories

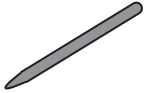
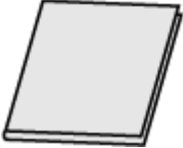
If any of the items are missing or defective, consult your JVC dealer or the nearest JVC service center.

Illustration	Description
	<p>AC Adapter AP-V30U</p> <ul style="list-style-type: none"> Connects to this unit to charge the battery pack. It can also be used when recording or playing back videos indoors.
	<p>Battery Pack BN-VG114E</p> <ul style="list-style-type: none"> Attaches to this unit to supply power.
	<p>Remote Control RM-V760U</p> <ul style="list-style-type: none"> Operates certain functions from a distance.
	<p>HDMI Mini Cable</p> <ul style="list-style-type: none"> Connects this unit to a TV to play back recorded images on the TV in a better quality.
	<p>AV Cable (exclusive)</p> <ul style="list-style-type: none"> Connects this unit to a TV to play back recorded images on the TV.
	<p>USB Cable (Type A - Mini Type B)</p> <ul style="list-style-type: none"> Connects this unit to a computer.
	<p>Stylus Pen</p> <ul style="list-style-type: none"> Use this for operations on the touch screen.
	<p>Basic User Guide</p> <ul style="list-style-type: none"> Read well and keep in a safe place where it can be accessed easily when necessary.
	<p>CD-ROM</p> <ul style="list-style-type: none"> For installing the provided software on a computer.

Memo :

- SD cards are sold separately.

“Types of Usable SD Card” (☞ p. 66)

- When using the AC adapter overseas, please prepare a commercially available converter plug for the country or region of visit.

“Charging the Battery Pack Overseas” (☞ p. 73)

Charging the Battery Pack

Charge the battery pack immediately after purchase and when the remaining battery power is low.

The battery pack is not charged at the time of purchase.

1 Attach the battery pack.

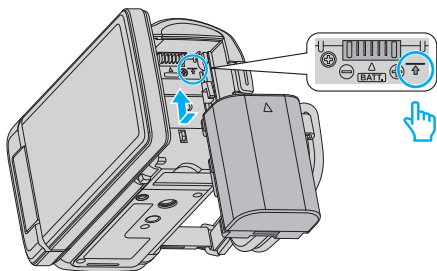

- Align the top of the battery with the mark on this unit, and slide in until the battery clicks into place.

2 Connect the AC adapter to the DC connector.

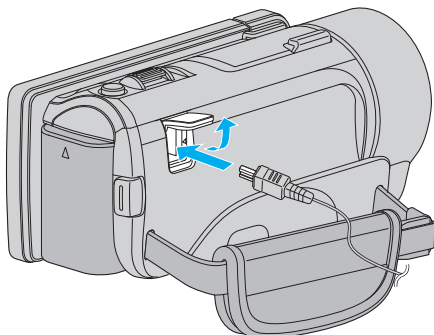

3 Plug in the power.

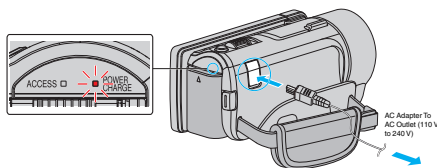

- The charging lamp blinks when charging is in progress. It goes out when charging is finished.

Caution :

Be sure to use JVC battery packs.

- If you use any other battery packs besides JVC battery packs, safety and performance cannot be guaranteed.
- Charging time: Approx. 2 h 30 m (using supplied battery pack)
The charging time is when the unit is used at 25°C (77°F). If the battery pack is charged outside the room temperature range of 10°C to 35°C (50°F to 95°F), charging may take a longer time or it may not start. The recordable and playable time may also be shortened under some usage conditions such as at low temperature.

Be sure to use the supplied AC adapter.

- If you use any other AC adapters besides the supplied AC adapter, malfunctions may occur.

Rechargeable Batteries :

- When using the battery in a low temperature environment (10°C (50°F) or below), the operating time may be shortened, or it may not function properly. When using this unit outdoors in the winter weather, warm the battery, such as by placing it in the pocket, before attaching it. (Keep away from direct contact with a warm pack.)
- Do not expose the battery to excessive heat, such as direct sunlight or fire.
- After removing the battery, store it in a dry place between 15°C to 25°C (59°F to 77°F).
- Keep a 30 % battery level () if the battery pack is not to be used for a long period of time. In addition, fully charge and then fully discharge the battery pack every 6 months, then continue to store it at a 30 % battery level ().

Memo :

- You can connect this unit to the AC adapter to record for long hours indoors.
(Battery charging begins when the LCD monitor is closed.)

Detaching the Battery Pack

To detach the battery pack, perform the above steps in reverse order.

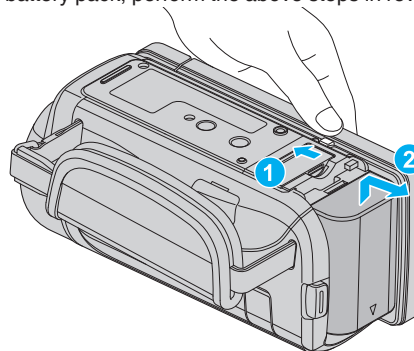

Slide the battery release lever to detach the battery from this unit.

Approximate Battery Charging Time (Using AC Adapter)

Battery Pack	Charging Time
BN-VG114U (Supplied)	2 h 30 m
BN-VG121U	3 h 30 m
BN-VG138U	6 h 10 m

- When the battery life is reached, the recording time becomes shorter even if the battery pack is fully charged.
(Replace the battery pack with a new one.)

* The charging time is when the unit is used at 25°C (77°F). If the battery pack is charged outside the room temperature range of 10°C to 35°C (50°F to 95°F), charging may take a longer time or it may not start. The recordable and playable time may also be shortened under some usage conditions such as at low temperature.

“Approximate Recording Time (Using Battery)” (p. 118)

Grip Adjustment

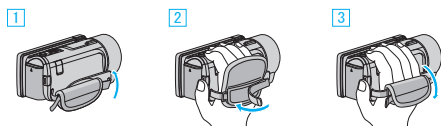

- 1 Pull back the pad
- 2 Adjust the length of the belt
- 3 Attach the pad

Caution :

- Be sure to fasten the grip belt properly.
If the belt is loose, this unit may drop and result in injuries or damages.

Inserting an SD Card

Insert a commercially available SD card before recording.
 “Types of Usable SD Card” (p. 66)
 “Approximate Video Recording Time” (p. 118)

- 1 Close the LCD monitor.

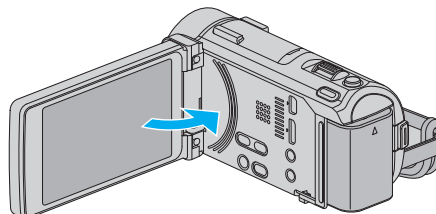

- 2 Open the cover.

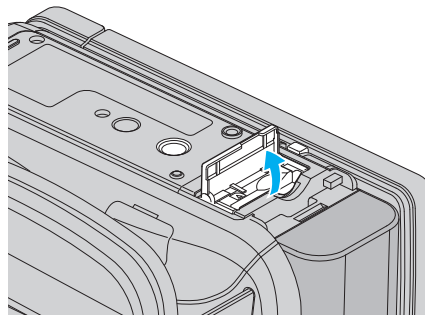

- 3 Insert an SD card.

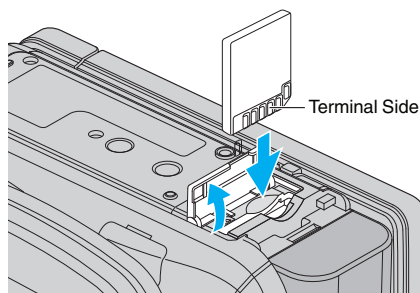

Warning

- Make sure not to insert the SD card in the wrong direction. It may cause damage to the unit and SD card.
- Turn off the power of this unit before inserting or removing an SD card.
- Do not touch the metal contact area when inserting the SD card.
- This unit is not guaranteed to operate with all SD cards. Some SD cards may not work due to specification changes, etc.

Memo :

- Both videos and still images can be recorded on one SD card. It is recommended to confirm the video operation of the SD card before usage.
- To use SD cards that have been used on other devices, it is necessary to format (initialize) the SD card using “FORMAT SD CARD” from media settings.

“FORMAT SD CARD” (p. 205)

Removing the Card

Push the SD card inward once, then pull it out straight.

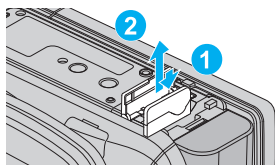

Types of Usable SD Card

The following SD cards can be used on this unit.

Operations are confirmed on the SD cards from the following manufacturers.

- Panasonic
- TOSHIBA
- SanDisk

SD Card



- This unit supports 256 MB to 2 GB SD cards.
- Use a Class 4 or higher compatible SD card (2 GB) for video recording.

SDHC Card



- Use a Class 4 or higher compatible SDHC card (4 GB to 32 GB) for video recording.

SDXC Card



- Use a Class 4 or higher compatible SDXC card (Max. 64 GB) for video recording.

Memo :

- Using SD cards (including SDHC/SDXC cards) other than those specified above may result in recording failure or data loss.
- This unit is not guaranteed to operate with all SD cards. Some SD cards may not work due to specification changes, etc.

- To record videos with "VIDEO QUALITY" set to "UXP", use of a Class 6 or higher compliant SDHC/SDXC card is recommended.
- When recording in progressive format (60p), Class 6 or higher is required.
- Class 4 and Class 6 are guaranteed to have a minimum transfer rate of 4 MB/s and 6 MB/s respectively during reading or writing of data.
- You can also use a Class 10 compliant SDHC/SDXC card.
- Both videos and still images can be recorded on one SD card. It is recommended to confirm the video operation of the SD card before usage.
- To protect the data, do not touch the terminals of the SD card.
- UHS-I SDHC/SDXC cards can be used in the same manner as standard SDHC/SDXC cards.
UHS Speed Class is not supported.

When your computer cannot recognize the SDXC card

Confirm and update the OS of your computer.

Windows XP / Windows XP SP1	Necessary to update to SP2 or higher.
Windows XP SP2 / Windows XP SP3	Necessary to download the update software. (KB955704) http://www.microsoft.com/downloads/details.aspx?FamilyID=1cbe3906-ddd1-4ca2-b727-c2dff5e30f61&displaylang=en
Windows Vista	Necessary to update to SP1 or higher.
Windows Vista SP1 / Windows Vista SP2	Necessary to download the upgrade software. (KB975823) <ul style="list-style-type: none"> • 32 bit version http://www.microsoft.com/downloads/en/details.aspx?FamilyID=2d1abe01-0942-4f8a-abb2-2ad529de00a1 • 64 bit version http://www.microsoft.com/downloads/en/details.aspx?FamilyID=7d54c53f-017c-4ea5-ae08-34c3452ba315
Windows 7	Necessary to download the upgrade software. (KB976422) <ul style="list-style-type: none"> • 32 bit version http://www.microsoft.com/downloads/en/details.aspx?FamilyID=3ee91fc2-a9bc-4ee1-aca3-2a9aff5915ea • 64 bit version http://www.microsoft.com/downloads/en/details.aspx?FamilyID=73f766dd-7127-4445-b860-47084587155f
Mac OS X 10.4 Tiger / Mac OS X 10.5 Leopard	Not compatible.
Mac OS X 10.6 Snow Leopard	Necessary to update to 10.6.5 or later.

Using the Touch Screen

Icon operation buttons, thumbnails, and menu items are displayed on the touch screen according to the mode in use.

- There are two ways to operate the touch screen, namely “tap” and “drag”. The following are some examples.

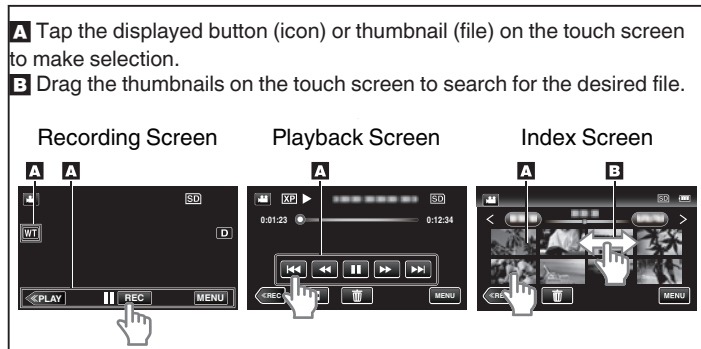

Memo :

- The touch screen of this unit is pressure-sensitive. When the touch screen does not respond smoothly, apply slightly more force to your fingertip or the stylus pen.
 - Tap the buttons (icons) on the touch screen accurately. The buttons may not respond if they are not tapped on the right area.
 - Do not press or rub with excessive force.
 - Do not operate the touch screen using an object with a sharp tip.
 - Pressing two or more places at a time may cause a malfunction.
 - Perform “TOUCH SCREEN ADJUST” if the reactive area of the screen is misaligned with the touched area. (Adjust by lightly tapping with the stylus pen. Do not press with an object with a sharp tip or do not press hard.)
- “TOUCH SCREEN ADJUST” (p. 202)
- It is recommended to use the stylus pen for handwriting effect.

Names of Buttons and Functions on the LCD Monitor

The following screens are displayed during the video and still image modes, and operate as the touch screens.

Recording Screen (Video/Still Image)

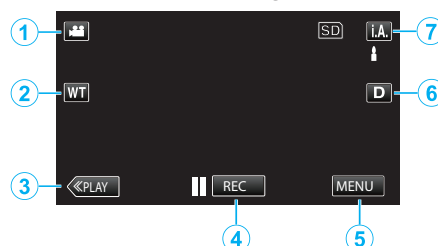

- 1** Video/Still Image Mode Button
 - Switches between video and still image modes.
- 2** Zoom Button
 - “Zooming” (p. 79)
- 3** Playback Mode Button
 - Switches to the playback mode.
- 4** Recording Start/Stop Button
 - REC: Video Recording Start Button
 - REC: Video Recording Stop Button
 - : Still Image Recording Button
- 5** Menu Button
 - “Operating the Menu” (p. 169)
- 6** Display Button
 - Switches the display between full (**Df**) and simple (**D**) with every tap of the button.
 - Simple display: Some displays disappear after approximately 3 seconds.
 - Full display: Displays everything. The display button changes from **D** to **Df**.
 - When the power is turned off, simple display (**D**) will be set.
- 7** Recording Mode Button
 - Switches the recording mode between **i.A.** Intelligent Auto and **M** Manual.

Playback Screen (Video)

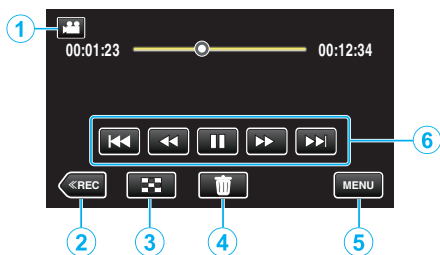

- 1 Video/Still Image Mode Button
 - Switches between video and still image modes.
- 2 Recording Mode Button
 - Switches to the recording mode.
- 3 Index Screen Button
 - “Operation Buttons for Video Playback” (☞ p. 119)
- 4 Delete Button
 - “Deleting the Currently Displayed File” (☞ p. 129)
- 5 Menu Button
 - “Operating the Menu” (☞ p. 169)
- 6 Operation Buttons
 - “Operation Buttons for Video Playback” (☞ p. 119)

Playback Screen (Still Image)

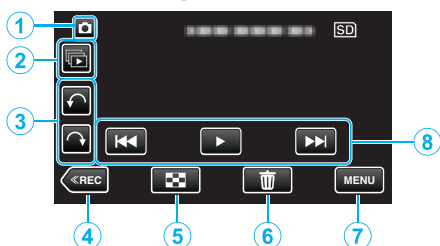

- 1 Video/Still Image Mode Button
 - Switches between video and still image modes.
- 2 Group Playback Button
 - Continuous playback of still images that are recorded continuously within 2 seconds or with the continuous shooting mode.
 - “Playing Back Still Images” (☞ p. 123)
- 3 Rotate Button
 - Rotates a still image 90°. (Clockwise/Counterclockwise)
- 4 Recording Mode Button
 - Switches to the recording mode.
- 5 Index Screen Button
 - “Operation Buttons for Still Image Playback” (☞ p. 123)
- 6 Delete Button
 - “Deleting the Currently Displayed File” (☞ p. 129)
- 7 Menu Button
 - “Operating the Menu” (☞ p. 169)
- 8 Operation Buttons
 - “Operation Buttons for Still Image Playback” (☞ p. 123)

Index Screen

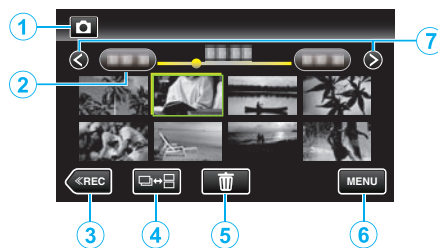

- 1 Video/Still Image Mode Button
 - Switches between video and still image modes.
- 2 Date Button
 - “Operation Buttons for Video Playback” (☞ p. 119)
 - “Operation Buttons for Still Image Playback” (☞ p. 123)
- 3 Playback Mode Button
 - Switches to the playback mode.
- 4 Still Image Mode Button (Still image only)
 - Switches between the group or full index screen displays.
- 5 Delete Button
 - “Deleting Selected Files” (☞ p. 129)
- 6 Menu Button
 - “Operating the Menu” (☞ p. 169)
- 7 Page Forward/Back Button
 - “Operation Buttons for Video Playback” (☞ p. 119)
 - “Operation Buttons for Still Image Playback” (☞ p. 123)

Menu Screen

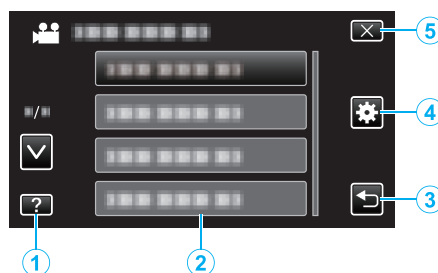

- 1 Help Button
- 2 Menu Items
- 3 Return Button
- 4 Common Menu Button
 - “Operating the Menu” (☞ p. 169)
- 5 Close Button

Clock Setting

The "SET DATE/TIME!" screen appears when you turn on this unit for the first time after purchase, when it has not been used for a long time, or when the clock is not set yet.

Set the clock before recording.

- 1 Open the LCD monitor.

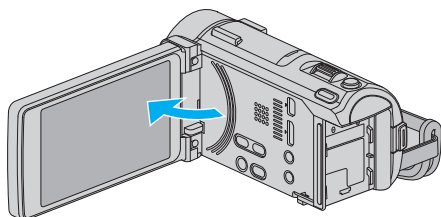

- The unit turns on.
- When the LCD monitor is closed, the unit turns off.

- 2 Tap "YES" when "SET DATE/TIME!" is displayed.

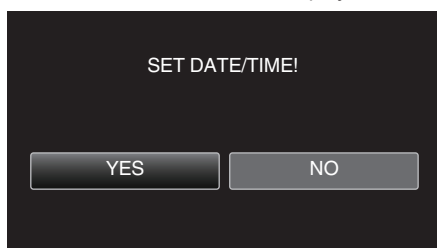

- 3 Set the date and time.

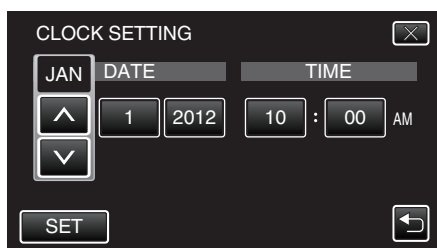

- When the year, month, day, hour, or minute item is tapped, "∧" and "∨" will be displayed.
- Tap ∧ or ∨ to adjust the year, month, day, hour, and minute.

- 4 After setting the date and time, tap "SET".

- 5 Select the region where you live and tap "SAVE".

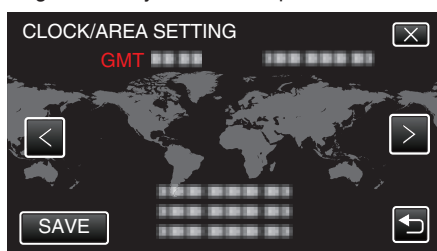

- The city name and time difference are displayed.
- Tap < or > to select the city name.

Memo :

- The clock can be reset again later.

"Resetting the Clock" (☞ p. 69)

- When using this unit overseas, you can set it to the local time for recording.

"Setting the Clock to Local Time when Traveling" (☞ p. 74)

- "SET DATE/TIME!" is displayed when you turn on this unit after it has not been used for a prolonged period.

Connect the AC adapter for more than 24 hours to charge the internal clock battery of this unit before setting the clock.

Resetting the Clock

Set the clock with "CLOCK ADJUST" from the menu.

- 1 Tap "MENU".

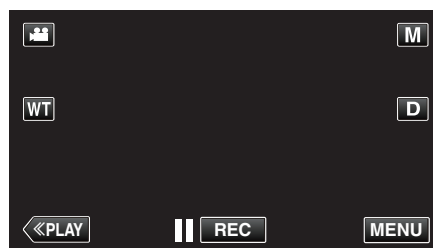

- When entering from the recording mode, tap "MENU" again as the shortcut menu appears.

- 2 Tap "⚙️".



- 3 Tap "CLOCK ADJUST".

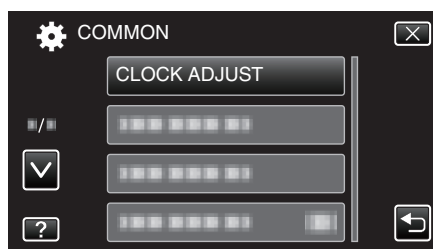

- Tap ∧ or ∨ to move upward or downward for more selection.

- 4 Tap "CLOCK SETTING".

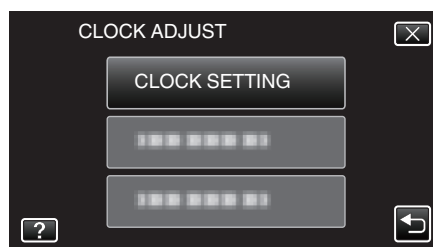

5 Set the date and time.

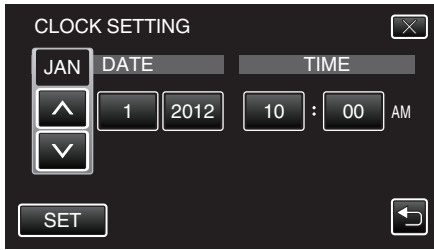

- When the year, month, day, hour, or minute item is tapped, “^” and “v” will be displayed.
- Tap ^ or v to adjust the year, month, day, hour, and minute.

6 After setting the date and time, tap “SET”.

7 Select the region where you live and tap “SAVE”.

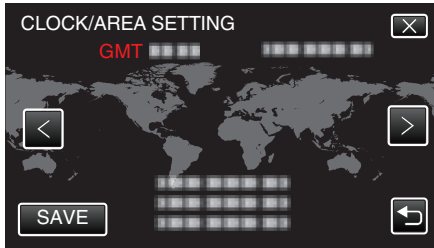

- The city name and time difference are displayed.
- Tap < or > to select the city name.

Changing the Display Language

The language on the display can be changed.

1 Tap “MENU”.

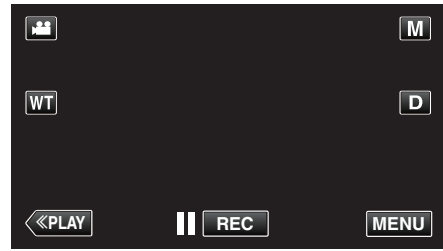

- When entering from the recording mode, tap “MENU” again as the shortcut menu appears.

2 Tap “⚙️”.



3 Tap “LANGUAGE”.

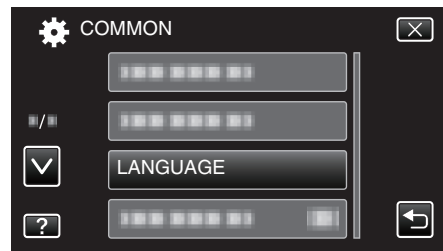

- Tap ^ or v to move upward or downward for more selection.

4 Tap to the desired language.

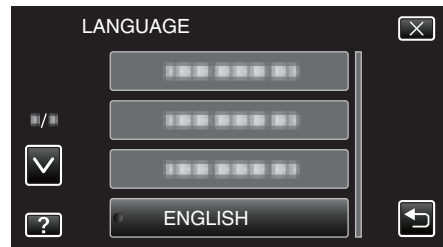

- Tap ^ or v to move upward or downward for more selection.

Holding this Unit

When holding this unit, keep your elbows close to your sides to prevent camera shake.

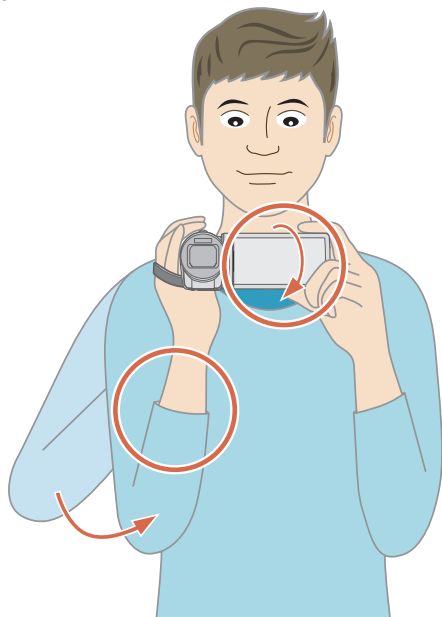

- Hold the LCD monitor with your left hand and adjust the angle accordingly. Holding the LCD monitor with your left hand helps to stabilize the camera for recording.

Caution :

- Be careful not to drop this unit during transportation.
- Guardians should pay close attention when this unit is being used by children.

Memo :

- If camera shake is excessive, use the image stabilizer. "Reducing Camera Shake" (p. 110)

Tripod Mounting

This unit can be mounted on a tripod (or monopod). This is useful for preventing camera shake and recording from the same position.

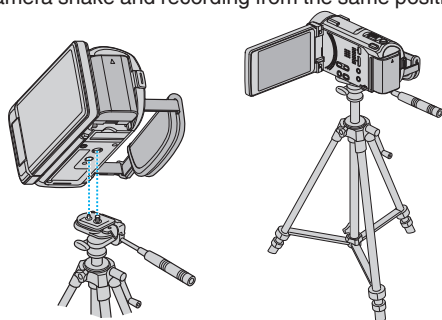

- To prevent this unit from falling off, check the tripod mounting screw holes and positioning holes on the unit carefully before mounting, and turn the screws until they are fastened firmly.

Caution :

- To prevent injuries or damages which may result if this unit falls off, read the instruction manual of the tripod (or monopod) to be used and make sure that it is securely attached.

Memo :

- It is recommended to use a tripod or monopod when recording in conditions prone to camera shake (such as in dark places or when zoomed to the telephoto end).
- Set the image stabilizer to  (OFF) when using a tripod for recording.

"Reducing Camera Shake" (p. 110)

Using the Remote Control

You can operate this unit from a distance away using the supplied remote control.

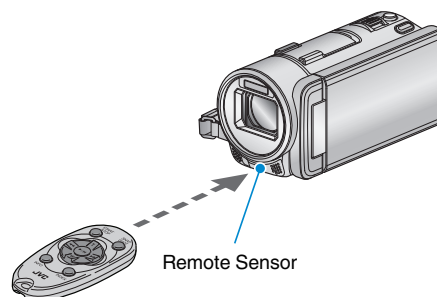

Memo :

- Point the remote control toward the sensor directly and use it within 5 m from this unit.
- The transmitted beam may not be effective or may cause incorrect operation when the sensor is directly exposed to sunlight or powerful lighting.

Preparing the Remote Control

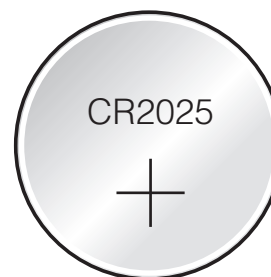

Using the Remote Control for the First Time

Pull out the insulation sheet

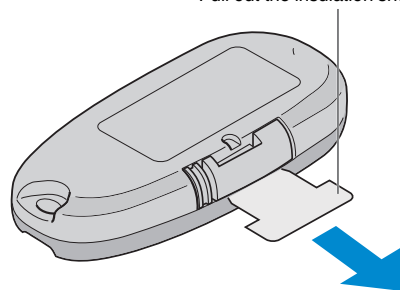

- A button battery (CR2025) is included inside the remote control at the time of purchase. Remove the insulation sheet before use.

Reinserting the Battery

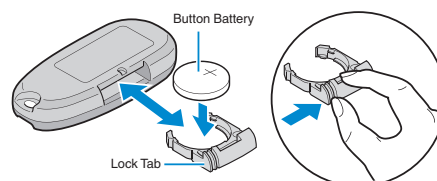

- Pull out the battery holder by pressing the lock tab.
- Insert the button battery with the + side facing upward.

Operation Buttons on Remote Control Unit

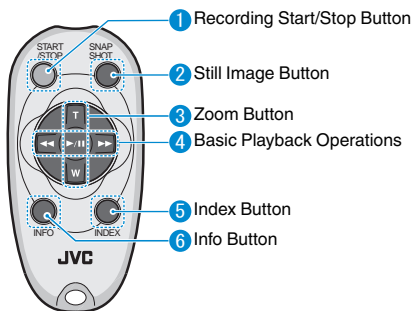

- 1** Recording Start/Stop Button
- Starts/stops video recording.

- 2** Still Image Button
- Takes a still image.

- 3** Zoom Button
- T: Zooms in
 - W: Zooms out

- 4** Basic Playback Operations

Operation Button	Description
Playback/Pause Button ▶ /	<ul style="list-style-type: none"> Starts/pauses playback of videos or slideshows.
Left Button ◀◀	<ul style="list-style-type: none"> Moves the cursor to the left. Performs reverse search during playback.
Right Button ▶▶	<ul style="list-style-type: none"> Moves the cursor to the right. Performs forward search during playback.
T Button T	<ul style="list-style-type: none"> Zooms in. (during pause) Turns up (+) the volume during video playback.
W Button W	<ul style="list-style-type: none"> Zooms out. (during pause) Turns down (-) the volume during video playback.

- 5** Index Button
- Stops playback and returns to index screen.

- 6** Info Button
- Recording: Displays the remaining time (for video only) and battery power.
 - Playback: Displays file information such as recording date.

Attaching Headphones

You can attach optional headphones to this unit.

- 1** Open the LCD monitor.

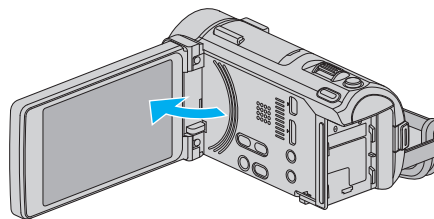

- 2** Connect the headphones to the headphones connector.

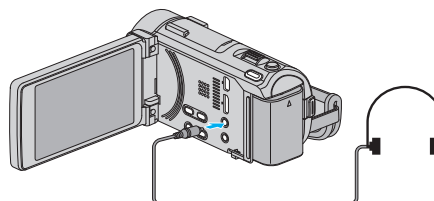

Memo :

- The volume level of the headphones can be adjusted using "HEADPHONE VOL. ADJ." in the menu.
- "HEADPHONE VOL. ADJ." (p. 182)
- Audio cannot be output from the AV connector when headphones are connected.

Attaching an External Microphone

You can attach an external microphone (commercially available) to this unit.

- Use a microphone that supports plug-in power.

1 Open the shoe cover.

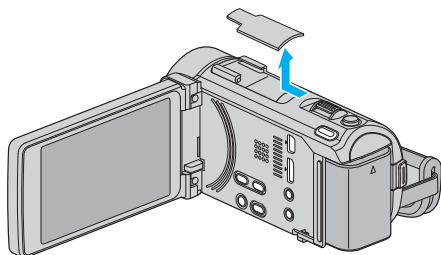

2 Attach an external microphone (commercially available) to the shoe.

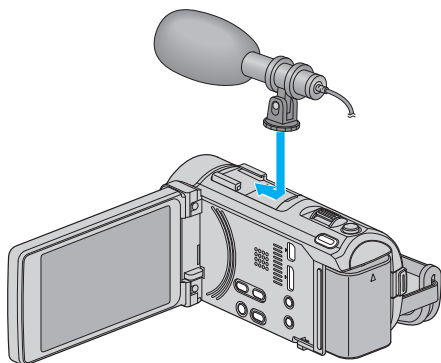

3 Connect the cable of the external microphone to the microphone connector.

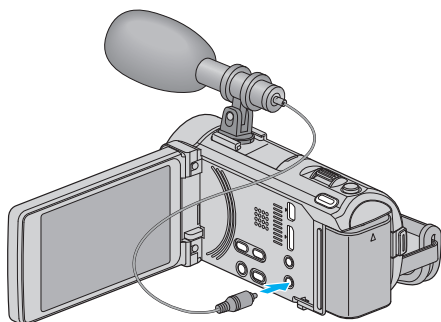

Memo :

- Do not apply too much force when attaching accessories such as an external microphone.
- The microphone level display and setting can be changed in the menu.
 “MIC LEVEL” (p. 181)
 “MIC LEVEL SETTING” (p. 182)

Using this Unit Overseas

The shape of the power outlet varies according to countries and regions. To charge the battery pack, you need a converter plug that matches the shape of the outlet.

“Charging the Battery Pack Overseas” (p. 73)

Change the date and time display to the local time by selecting your travel destination in “AREA SETTING” of “CLOCK ADJUST”.

“Setting the Clock to Local Time when Traveling” (p. 74)

When “ON” is selected in “DST SETTING” of “CLOCK ADJUST”, the time is set 1 hour ahead.

“Setting Daylight Saving Time” (p. 74)

Charging the Battery Pack Overseas

The shape of the power outlet varies according to countries and regions. To charge the battery pack, you need a converter plug that matches the shape of the outlet.

A	B	BF	C	O

North America	Europe	Oceania	Middle East
United States A	Iceland C	Australia O	Israel C
Canada A	Ireland C	Guam A	Iran C
Mexico A	United Kingdom B,BF	Tahiti C	Kuwait B,C
	Italy C	Tonga O	Jordan B,BF
	Austria C	New Zealand O	
India B,C,BF	Netherlands C	Fiji O	
Indonesia C	Canary Islands C		
Singapore B,BF	Greece C		
Sri Lanka B,C,BF	Switzerland C		
Thailand A,BF,C	Sweden C		
South Korea A,C	Spain A,C		
China A,B,BF,C,O	Denmark C		
Nepal C	Germany C		
Pakistan B,C	Norway C		
Bangladesh C	Hungary C		
Philippines A,BF,O	Finland C		
Vietnam A,C	France C		
Hong Kong Special	Belgium C		
Administrative Region B,BF	Poland B,C		
Macau Special	Portugal B,C		
Administrative Region B,C	Romania C		
Malaysia B,BF,C			

Setting the Clock to Local Time when Traveling

Change the date and time display to the local time by selecting your travel destination in “AREA SETTING” of “CLOCK ADJUST”. Restore the region settings after you returned from the trip.

1 Tap “MENU”.

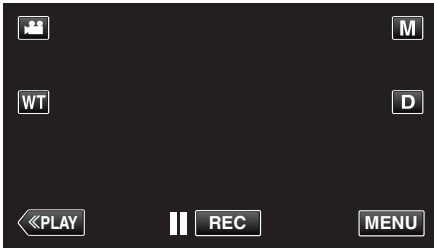

- When entering from the recording mode, tap “MENU” again as the shortcut menu appears.

2 Tap “⚙️”.



3 Tap “CLOCK ADJUST”.

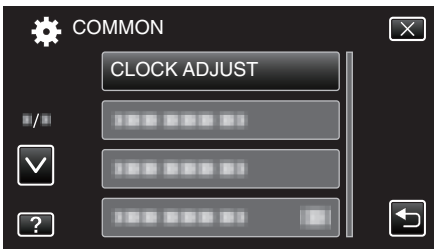

- Tap ^ or v to move upward or downward for more selection.

4 Tap “AREA SETTING”.

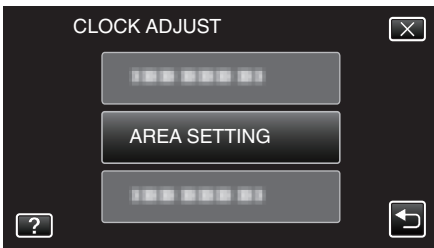

5 Select the area you are traveling to and tap “SAVE”.



- The city name and time difference are displayed.
- Tap < or > to select the city name.

Memo :

- Setting “AREA SETTING” changes the clock time such that time difference is accounted for.
After returning to your country, re-select the region that was set initially to restore the original clock settings.

Setting Daylight Saving Time

When “ON” is selected in “DST SETTING” of “CLOCK ADJUST”, the time is set 1 hour ahead.

1 Tap “MENU”.

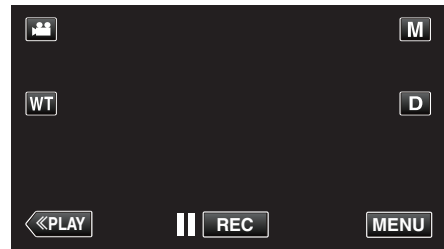

- When entering from the recording mode, tap “MENU” again as the shortcut menu appears.

2 Tap “⚙️”.



3 Tap “CLOCK ADJUST”.

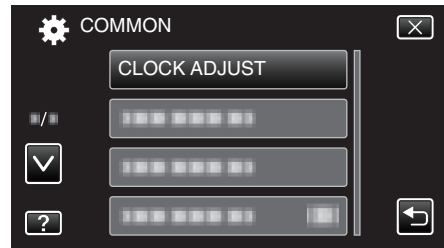

- Tap ^ or v to move upward or downward for more selection.

4 Tap “DST SETTING”.

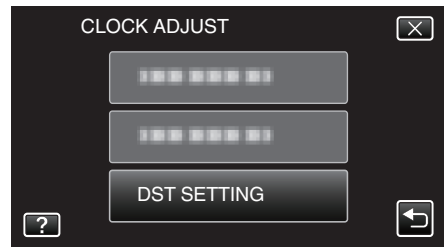

5 Tap “ON”.

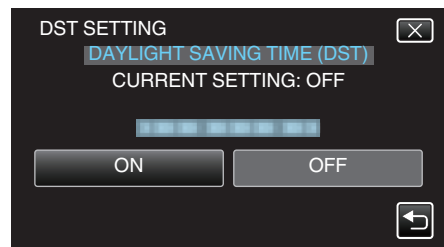

Memo :

- What is daylight saving time?
Daylight saving time is the system of setting the clock 1 hour ahead for a fixed period in summer. It is used mainly in the Western countries.
- Restore the daylight saving time settings after you returned from the trip.

Optional Accessories

You can record for a longer time by using the optional battery pack.

Product Name	Description
Battery Pack <ul style="list-style-type: none"> • BN-VG114U • BN-VG121U • BN-VG138U 	<ul style="list-style-type: none"> • Provides a longer recording time. It can also be used as a spare battery pack.
Battery Charger <ul style="list-style-type: none"> • AA-VG1 	<ul style="list-style-type: none"> • Enables the battery pack to be charged without using this unit.

Memo :

- The optional accessories above may not be supported in some regions.
- For more information, refer to the catalog.
- For details on the provided accessories, refer to “Verifying the Accessories”.

“Verifying the Accessories” (p. 62)

- BN-VG114U is the same battery pack that comes with this unit.

Approximate Recording Time (Using Battery)

Battery Pack	Actual Recording Time	Continuous Recording Time
BN-VG114U (Supplied)	40 m	1 h 15 m
BN-VG121U	1 h 5 m	1 h 55 m
BN-VG138U	1 h 55 m	3 h 25 m

- The above are values when “LIGHT” is set to “OFF”, “MONITOR BRIGHTNESS” is set to “3” (standard), and “SYSTEM SELECT” is set to “60”.
- The actual recording time may be shorter if zooming is used or if recording is stopped repeatedly.
(It is recommended to prepare battery packs ready for three times the expected recording time.)
- When the battery life is reached, the recording time becomes shorter even if the battery pack is fully charged.
(Replace the battery pack with a new one.)

Taking Videos in Auto Mode

You can record without worrying about the setting details by using the Intelligent Auto mode. Settings such as exposure and focus will be adjusted automatically to suit the shooting conditions.

- In case of specific shooting scenes such as person etc., its icon is displayed on the screen.
- Before recording an important scene, it is recommended to conduct a trial recording.

1 Open the LCD monitor.

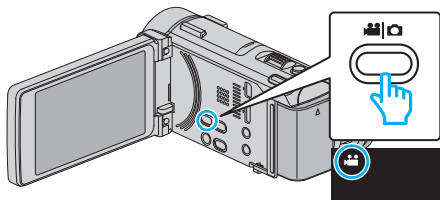

- Check if the recording mode is .
- If the mode is still image, tap on the recording screen to display the mode switching screen. Tap to switch the mode to video.

2 Check if the recording mode is **i.A.** Intelligent Auto.

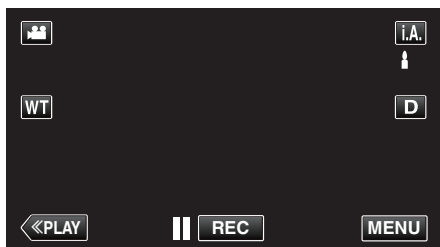

- If the mode is Manual, tap on the recording screen to display the mode switching screen. Tap **i.A.** to switch the recording mode to Intelligent Auto.

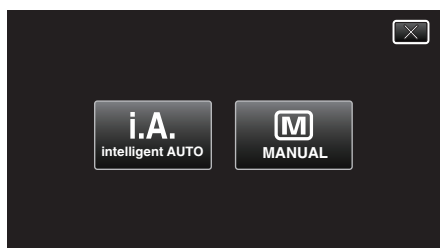

3 Start recording.

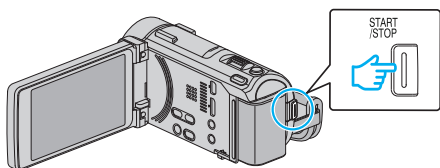

- Press again to stop.
- Some displays disappear after approximately 3 seconds. Use the **D** button to change the displays.

Memo :





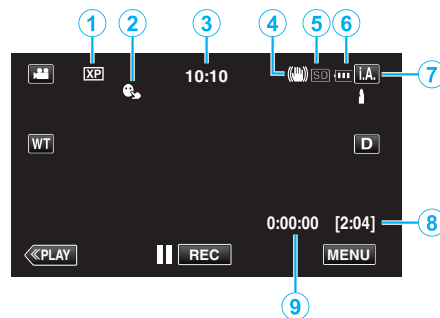







- Depending on the subject and shooting conditions, recording may not be performed properly even in the Intelligent Auto mode.

Indications During Video Recording



	Display Icon	Description
①	Video Quality	Displays the icon of the “VIDEO QUALITY” setting selected in the recording menu. “VIDEO QUALITY” (☞ p. 179)
②	TOUCH PRIORITY AE/AF	Displays the setting of “TOUCH PRIORITY AE/AF”. By default, it is set to “FACE TRACKING”. “Capturing Subjects Clearly (TOUCH PRIORITY AE/AF)” (☞ p. 99)
③	Time	Displays the current time. “Clock Setting” (☞ p. 69)
④	Image Stabilizer	Displays the image stabilizer setting. “Reducing Camera Shake” (☞ p. 110)
⑤	Recording Media	Displays the icon of the media where videos are recorded to.
⑥	Battery Indicator	Displays the approximate remaining battery power. “Checking the Remaining Recording Time” (☞ p. 117)
⑦	Recording Mode	Displays the current recording mode of i.A. (Intelligent Auto) or M (Manual).
⑧	Remaining Recording Time	Displays the remaining time for video recording. “Checking the Remaining Recording Time” (☞ p. 117)
⑨	Scene Counter (Recorded Time)	Displays the elapsed time of the video that is currently being recorded.

■ Scenes of Intelligent Auto

Display Icon	Description
	Captures one's skin beautifully.
	Allows people to be captured naturally.
	Focuses at a far distance and captures a sharp image with vivid colors.
	Records with minimal noise in the overall image.
	Allows night scenes to be captured accurately with minimal noise in the overall image.
	Prevents colors from fading even when recording in a bright environment.
	Records while focusing on a near object.
	Reproduces the green color of trees vividly.
	Reproduces the colors of sunset naturally.
	Adjusts settings so that the subject does not appear too dark due to backlight.
	Allows people to be captured naturally with minimal noise in the overall image.
	Records while focusing on a near object even in a dark environment.

Memo :

- Scenes can be detected according to the shooting conditions and automatically adjusted in Intelligent Auto mode.
- Some functions may not work properly depending on the shooting conditions.

Operation Buttons for Video Recording

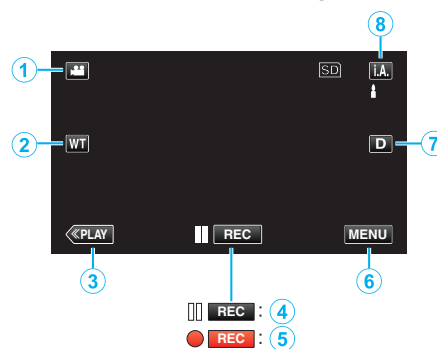

	Operation Button	Description
①	Video/Still Image Mode	Switches between video and still image modes.
②	T/W Zoom	Allows the same functions as the zoom lever to be performed. Camera shake that often occurs when using the zoom lever can be minimized. "Zooming" (p. 79)
③	Playback Mode	Switches to the playback mode.
④ / ⑤	Recording Start Record-Standby	Functions as the START/STOP button.
⑥	MENU	Displays the various menus of video recording. "Operating the Menu" (p. 169)
⑦	Display Button D	Switches the display between full (D_F) and simple (D) with every tap of the button. <ul style="list-style-type: none"> • Simple display: Some displays disappear after approximately 3 seconds. • Full display: Displays everything. The display button changes from D to D_F. • When the power is turned off, simple display (D) will be set.
⑧	Recording Mode i.A./M	Switches the recording mode.

Using the Silent Mode

When the Silent mode is used, the LCD monitor darkens and operation sounds will not be output. Use this mode to record quietly in dark places such as during a performance.

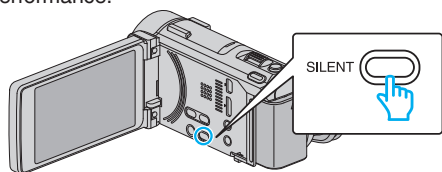

- Press and hold the SILENT button to turn on the Silent mode. To turn it off, press and hold the button again.
 -  appears when "SILENT MODE" is set to "ON".
- "SILENT MODE" (☞ p. 199)

Useful Settings for Recording

- When "QUICK RESTART" is set to "ON", this unit turns on immediately if you open the LCD monitor within 5 minutes after the power is turned off by closing the monitor.
- "QUICK RESTART" (☞ p. 200)
- When "AUTO POWER OFF" is set to "ON", this unit turns itself off automatically to conserve power when it is not operated for 5 minutes. (only when using the battery pack)
- "AUTO POWER OFF" (☞ p. 200)
- When "TOUCH PRIORITY AE/AF" is set to "FACE TRACKING", this unit detects faces and automatically adjusts its brightness and focus to record the faces more clearly.
- "Capturing Subjects Clearly (TOUCH PRIORITY AE/AF)" (☞ p. 99)
- When "DATE/TIME RECORDING" is used, the date and time can be recorded together with the video.
- "Recording Videos with Date and Time" (☞ p. 116)
- When progressive (60p) recording is set, high quality images with a smooth depth of field can be recorded. In addition, fast-moving subjects can also be captured sharply without flickering.
- "SYSTEM SELECT" (☞ p. 179)

Caution :

- Do not expose the lens to direct sunlight.
 - Do not use this unit in the rain, snow, or places with high humidity like the bathroom.
 - Do not use this unit in places subject to excessive humidity or dust, as well as places exposed to steam or smoke directly.
 - While this unit may be used with the LCD monitor reversed and closed, the temperature rises more easily. Leave the LCD monitor open when using this unit in places exposed to direct sunlight or high temperatures.
 - The power may turn off to protect the circuit if the temperature of this unit rises too much.
 - If the temperature of this unit rises during recording, ● **REC** changes color to yellow as a notification.
 - Do not remove the battery pack, AC adapter, or SD card when the access lamp is lighted. The recorded data may become unreadable.
- "ACCESS (Access) Lamp" (☞ p. 208)
- This unit is a microcomputer-controlled device. Electrostatic discharge, external noise and interference (from a TV, a radio, etc.) might prevent it from functioning properly. In such a case, turn off the power, then remove the AC adapter and battery pack. This unit will be reset.
 - Videos that are recorded in the 60p mode (when "SYSTEM SELECT" is set to "60p") are playable only on AVCHD Progressive compatible devices.
- "SYSTEM SELECT" (☞ p. 179)
- Make a backup of important recorded data.
 - It is recommended to copy your important recorded data to a DVD or other recording media for storage.
 - JVC will not be responsible for any lost data.

Memo :

- Check the remaining recording time in the media before you start shooting. If there is not enough space, move (copy) the data to a computer or disc.
- When there are many files in the media, it may take time for them to be displayed on the playback screen. Wait for a while as the access lamp appears blinking, which indicates normal operation.

- Do not forget to make copies after recording!
- Recording stops automatically as it cannot be performed for 12 or more consecutive hours according to specifications. (It may take some time to resume recording.)
- For long recordings, the file is split into two or more files if the size exceeds 4 GB.
- You can connect this unit to the AC adapter to record for long hours indoors.
- Depending on the shooting conditions, the four corners of the screen may appear dark, but this is not a malfunction. In this case, change the shooting conditions by moving the zoom lever, etc.

Zooming

The angle of view can be adjusted using zoom.

- Use the W end (wide angle end) to shoot a wider field of view.
- Use the T end (telephoto end) to magnify the subject for shooting.

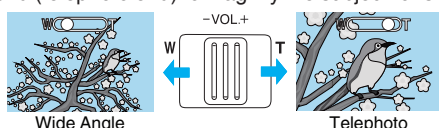

- You can also use the zoom (T/W) button on the touch screen to zoom.

Zoom Button (T/W)

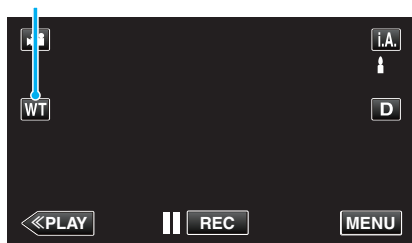

Memo :

- When digital zoom is used, the image becomes grainy as it is digitally enlarged.
- The zoom ratio range can be changed.

“ZOOM” (p. 180)

Capturing Still Images During Video Recording

Still images can be captured by pressing the SNAPSHOT button while in the video mode (standby or recording).

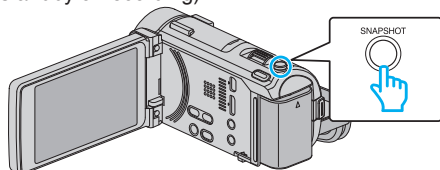

- “PHOTO” lights up on the screen when a still image is being captured.



Memo :

- The size of the still image that is captured in the video mode is 1920 x 1080.
- Operation is invalid under the following conditions:
 - when menu is being displayed
 - when remaining recording time or battery power is being displayed
 - when “TIME-LAPSE RECORDING” is in use
 - when “FACE SUB-WINDOW” is set
 - when “ANIMATION EFFECT” is set
 - when “HIGH SPEED RECORDING” is set
 - when “DECORATE FACE EFFECT” is set
 - when “STAMP” is set
 - when “HANDWRITING EFFECT” is set
 - when “AUTO REC” is set
 - when “DATE/TIME RECORDING” is set

Taking Still Images in Auto Mode

You can record without worrying about the setting details by using the Intelligent Auto mode.

- 1 Open the LCD monitor.

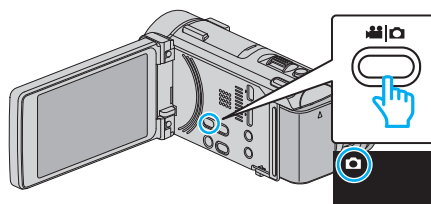

- Check if the recording mode is .
- If the mode is video, tap on the recording screen to display the mode switching screen. Tap to switch the mode to still image.

- 2 Check if the recording mode is **i.A.**, Intelligent Auto.

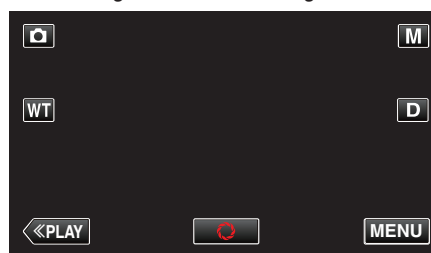

- If the mode is **M** Manual, tap **M** on the recording screen to display the mode switching screen. Tap **i.A.** to switch the recording mode to Intelligent Auto.

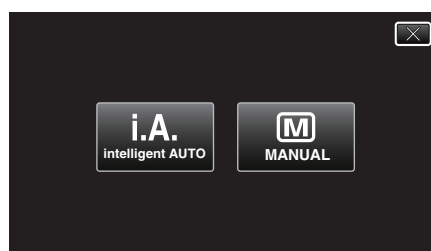

- 3 Set the focus on the subject.

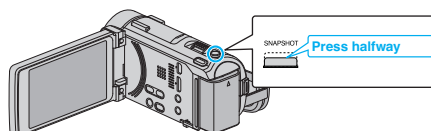

- When focused, the focus icon lights up in green.

- 4 Take a still image.

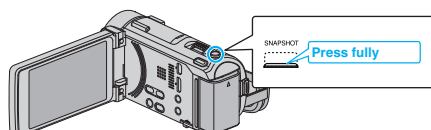

- PHOTO lights up when a still image is being captured.
- Some displays disappear after approximately 3 seconds. Use the **D** button to change the displays.

Memo :

- Depending on the subject and shooting conditions, recording may not be performed properly even in the Intelligent Auto mode.
- Image stabilization only starts when the button is pressed fully.

Indications During Still Image Recording

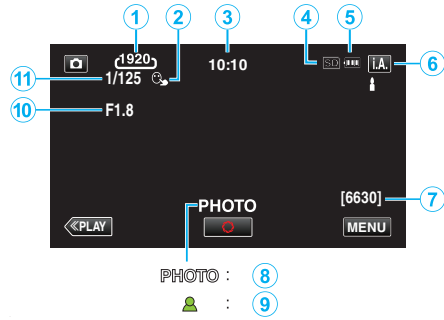

	Display Icon	Description
①	Image Size	Displays the icon of the image size. • The size of still images can be changed. “IMAGE SIZE” (☞ p. 190)
②	TOUCH PRIORITY AE/AF	Displays the setting of “TOUCH PRIORITY AE/AF”. By default, it is set to “FACE TRACKING” “Capturing Subjects Clearly (TOUCH PRIORITY AE/AF)” (☞ p. 99)
③	Time	Displays the current time. “Clock Setting” (☞ p. 69)
④	Recording Media	Displays the icon of the media where still images are recorded to.
⑤	Battery Indicator	Displays the approximate remaining battery power. “Checking the Remaining Recording Time” (☞ p. 117)
⑥	Recording Mode	Displays the current recording mode of i.A. (Intelligent Auto) or M (Manual).
⑦	Remaining Number of Shots	Displays the remaining number of shots for still image recording. “Approximate Number of Still Images (Unit: Number of Shots)” (☞ p. 118)
⑧	Recording in Progress	“PHOTO” appears when a still image is being captured.
⑨	Focus	Lights up in green when focused.
⑩	Aperture Value	Displays the aperture value.
⑪	Shutter Speed	Displays the shutter speed.

■ Scenes of Intelligent Auto

Display Icon	Description
	Captures one’s skin beautifully.
	Allows people to be captured naturally.
	Focuses at a far distance and captures a sharp image with vivid colors.
	Records with minimal noise in the overall image.
	Allows night scenes to be captured accurately with minimal noise in the overall image.
	Prevents colors from fading even when recording in a bright environment.
	Records while focusing on a near object.
	Reproduces the green color of trees vividly.
	Reproduces the colors of sunset naturally.
	Adjusts settings so that the subject does not appear too dark due to backlight.
	Allows people to be captured naturally with minimal noise in the overall image.
	Records while focusing on a near object even in a dark environment.

Memo :

- Scenes can be detected according to the shooting conditions and automatically adjusted in Intelligent Auto mode.
- Some functions may not work properly depending on the shooting conditions.

Operation Buttons for Still Image Recording



	Operation Button	Description
①	Video/Still Image Mode	Switches between video and still image modes.
②	T/W Zoom	Allows the same functions as the zoom lever to be performed. Camera shake that often occurs when using the zoom lever can be minimized. "Zooming" (p. 81)
③	Playback Mode	Switches to the playback mode.
④	Snapshot	Functions as the SNAPSHOT button. However, focus cannot be set by pressing halfway.
⑤	MENU	Displays the various menus of still image recording. "Operating the Menu" (p. 169)
⑥	Display Button D	Switches the display between full (D_F) and simple (D) with every tap of the button. <ul style="list-style-type: none"> Simple display: Some displays disappear after approximately 3 seconds. Full display: Displays everything. The display button changes from D to D_F. When the power is turned off, simple display (D) will be set.
⑦	Recording Mode i.A./M	Switches the recording mode.

Using the Silent Mode

When the Silent mode is used, the LCD monitor darkens and operation sounds will not be output. Use this mode to record quietly in dark places such as during a performance.

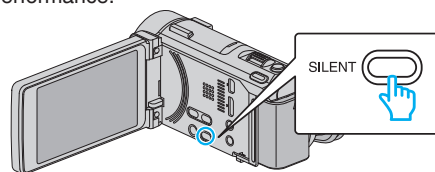

- Press and hold the SILENT button to turn on the Silent mode. To turn it off, press and hold the button again.
 - appears when "SILENT MODE" is set to "ON".
- "SILENT MODE" (p. 199)

Useful Settings for Recording

- When "QUICK RESTART" is set to "ON", this unit turns on immediately if you open the LCD monitor within 5 minutes after the power is turned off by closing the monitor.
- "QUICK RESTART" (p. 200)
- When "AUTO POWER OFF" is set to "ON", this unit turns itself off automatically to conserve power when it is not operated for 5 minutes. (only when using the battery pack)
- "AUTO POWER OFF" (p. 200)
- When "TOUCH PRIORITY AE/AF" is set to "FACE TRACKING", this unit detects faces and automatically adjusts its brightness and focus to record the faces more clearly.
- "Capturing Subjects Clearly (TOUCH PRIORITY AE/AF)" (p. 99)

Caution :

- Do not expose the lens to direct sunlight.
 - Do not use this unit in the rain, snow, or places with high humidity like the bathroom.
 - Do not use this unit in places subject to excessive humidity or dust, as well as places exposed to steam or smoke directly.
 - While this unit may be used with the LCD monitor reversed and closed, the temperature rises more easily. Leave the LCD monitor open when using this unit in places exposed to direct sunlight or high temperatures.
 - The power may turn off to protect the circuit if the temperature of this unit rises too much.
 - Do not remove the battery pack, AC adapter, or SD card when the access lamp is lighted. The recorded data may become unreadable.
- "ACCESS (Access) Lamp" (p. 208)
- This unit is a microcomputer-controlled device. Electrostatic discharge, external noise and interference (from a TV, a radio, etc.) might prevent it from functioning properly. In such a case, turn off the power, then remove the AC adapter and battery pack. This unit will be reset.

Memo :

- Before recording an important scene, it is recommended to conduct a trial recording.
- Depending on the shooting conditions, the four corners of the screen may appear dark, but this is not a malfunction. In this case, change the shooting conditions by moving the zoom lever, etc.

Zooming

The angle of view can be adjusted using zoom.

- Use the W end (wide angle end) to shoot a wider field of view.
- Use the T end (telephoto end) to magnify the subject for shooting.

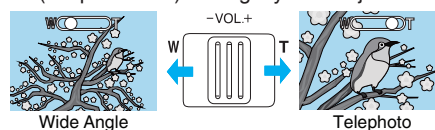

- The following zoom options are available:
 - Optical Zoom (1 - 10x)
- You can also use the zoom (T/W) button on the touch screen to zoom.

Zoom Button (T/W)

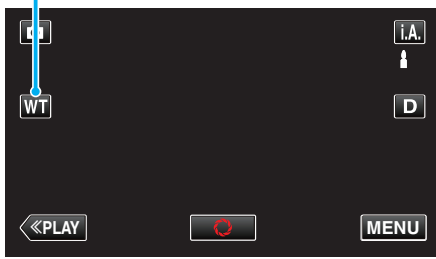

Memo :

- Only optical zoom is available in the still image recording mode.

Manual Recording

You can adjust settings, such as brightness and shutter speed, by using the manual mode.

Manual recording can be set for both video and still image modes.

1 Open the LCD monitor.

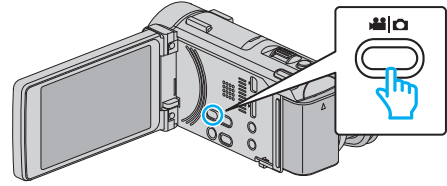

- Set the recording mode to either video or still image.
- To switch the mode between video and still image, tap or on the recording screen to display the mode switching screen. Tap or to switch the mode to video or still image respectively. (You can also use the button on this unit.)

2 Select the Manual recording mode.

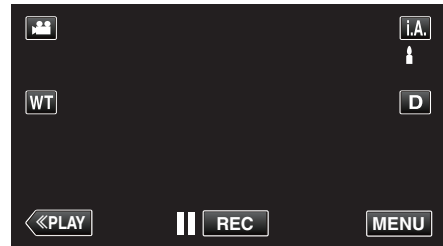

- If the mode is **i.A.**, Intelligent Auto, tap **i.A.** on the recording screen to display the mode switching screen. Tap **M** to switch the recording mode to Manual.

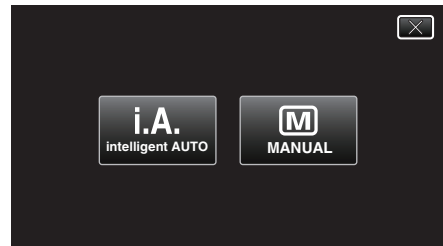

3 Tap "MENU".

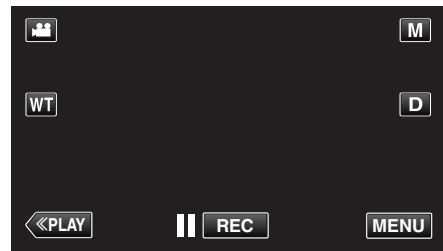

- The shortcut menu appears.

4 Tap "MENU" in the shortcut menu.

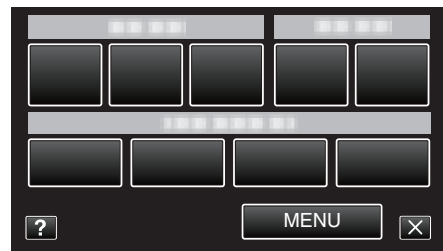

5 Tap the item to set manually.

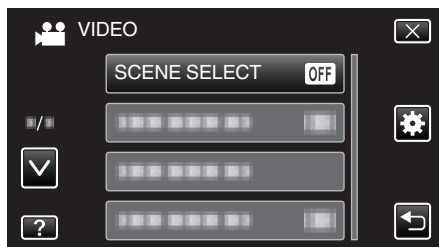

- For details on the various manual settings, refer to “Manual Recording Menu”.

Memo : _____

- The manual settings are displayed only in the manual mode.

Manual Recording Menu

The following items can be set.

Name	Description
SCENE SELECT	<ul style="list-style-type: none"> • Recordings that suit the shooting conditions can be performed easily. “Shooting According to Scene (Subject)” (☞ p. 84)
FOCUS	<ul style="list-style-type: none"> • Use manual focus if the subject is not focused automatically. “Adjusting Focus Manually” (☞ p. 86)
BRIGHTNESS ADJUST	<ul style="list-style-type: none"> • Overall brightness on the screen can be adjusted. • Use this when recording in a dark or bright location. “Adjusting Brightness” (☞ p. 87)
SHUTTER SPEED	<ul style="list-style-type: none"> • Shutter speed can be adjusted. • Use this when shooting a fast-moving subject or to emphasize the subject’s movement. “Setting Shutter Speed” (☞ p. 88)
APERTURE PRIORITY	<ul style="list-style-type: none"> • You can adjust the aperture to capture an image with only the subject in focus while blurring the surroundings. “Setting Aperture” (☞ p. 89)
WHITE BALANCE	<ul style="list-style-type: none"> • Overall color on the screen can be adjusted. • Use this when the color on the screen appears differently from the actual color. “Setting White Balance” (☞ p. 90)
BACKLIGHT COMP.	<ul style="list-style-type: none"> • Corrects the image when the subject appears dark due to backlight. • Use this when shooting against the light. “Setting Backlight Compensation” (☞ p. 91)
ZEBRA	<ul style="list-style-type: none"> • During video recording, diagonal lines (zebra pattern) are displayed only at areas with the specified luminance levels. *Displayed only in the manual recording mode. “Checking for Overexposed Areas (ZEBRA)” (☞ p. 92)
TELE MACRO	<ul style="list-style-type: none"> • Use this to take close-up (macro) shots of the subject. “Taking Close-up Shots” (☞ p. 93)

Recording

Shooting According to Scene (Subject)

Common scenes that are often encountered can be recorded with the most suitable settings.

1 Select the Manual recording mode.

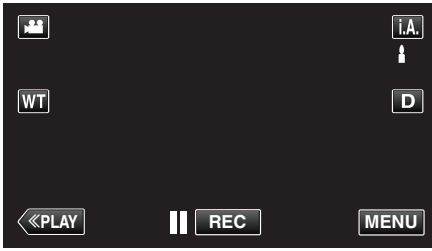

- If the mode is **i.A.** Intelligent Auto, tap **i.A.** on the recording screen to display the mode switching screen. Tap **M** to switch the recording mode to Manual.

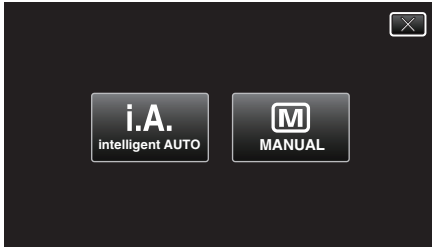

2 Tap "MENU".

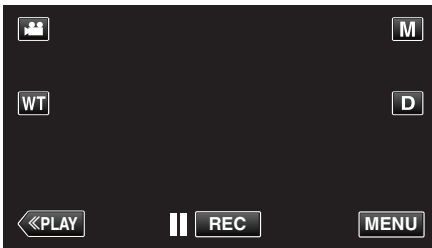

- The shortcut menu appears.

3 Tap "MENU" in the shortcut menu.

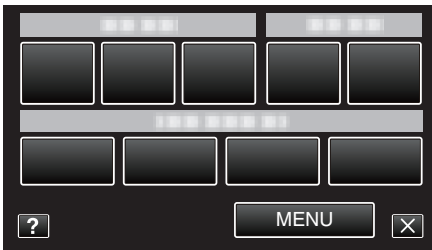

4 Tap "SCENE SELECT".

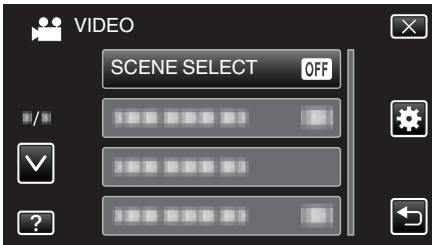





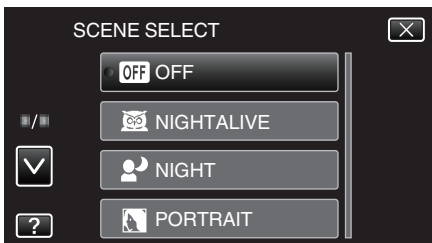



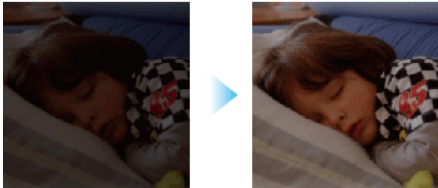

- Tap \wedge or \vee to move upward or downward for more selection.
- Tap \times to exit the menu.
- Tap \curvearrowright to return to the previous screen.

5 Tap the appropriate scene.

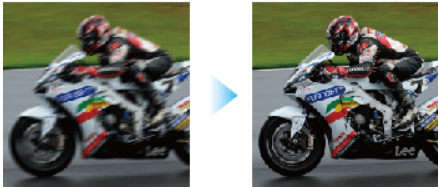

- Tap "OFF" to cancel the selection.
- Tap \wedge or \vee to move upward or downward for more selection.
- Tap \times to exit the menu.

*The image is only an impression.

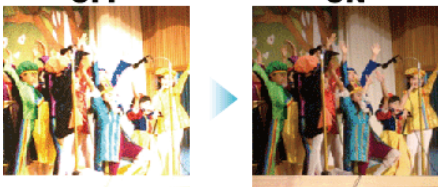
Setting	Effect
 NIGHTLIVE	<p>Increases gain and brightens the scene automatically using a slow shutter when the surrounding is dark. To prevent camera shake, use a tripod.</p> <p>OFF ON</p> 
 NIGHT	<p>Captures night scenes naturally.</p> <p>OFF ON</p>  <ul style="list-style-type: none"> • Capture the image brighter than the actual scene by using a slow shutter in the still image mode.
 PORTRAIT	<p>Blurs the background to bring out the people in the picture.</p> <p>OFF ON</p> 
 SPORTS	<p>Captures fast-moving subjects clearly in every single frame.</p> <p>OFF ON</p> 
 SNOW	<p>Prevents the subject from appearing too dark when recording snow scenes on a sunny day.</p> <p>OFF ON</p> 
 SPOTLIGHT	<p>Prevents the human subject from appearing too bright under light.</p> <p>OFF ON</p> 

- All scenes of “SCENE SELECT” cannot be set during “TIME-LAPSE RECORDING”, “HIGH SPEED RECORDING”, “AUTO REC”, or “FACE SUB-WINDOW”.

Memo : _____

Adjusting Focus Manually

Set this when the focus is not clear in Intelligent Auto or when manual focusing is desired.

1 Select the Manual recording mode.



- If the mode is **i.A.**, Intelligent Auto, tap **i.A.** on the recording screen to display the mode switching screen. Tap **M** to switch the recording mode to Manual.



2 Tap "MENU".

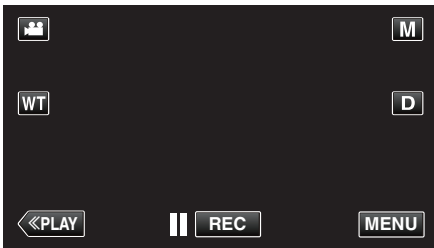

- The shortcut menu appears.

3 Tap "MENU" in the shortcut menu.

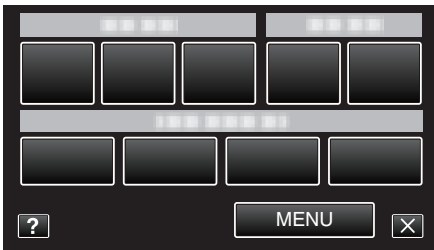

4 Tap "FOCUS".

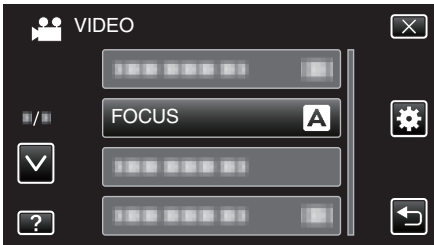

- Tap **^** or **v** to move upward or downward for more selection.
- Tap **X** to exit the menu.
- Tap **↶** to return to the previous screen.

5 Tap "MANUAL".

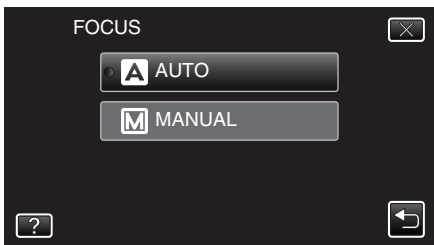

6 Adjust the focus.



- Tap **▲** to focus on a distant subject. If **▲** appears blinking, focus cannot be set any further.
- Tap **●** to focus on a near subject. If **●** appears blinking, focus cannot be set any nearer.

7 Tap "SET" to confirm.

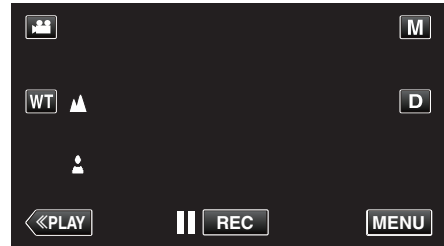

- When focus is confirmed, the focusing frame disappears and **▲** and **●** are displayed.

Memo :

- A subject that is focused at the telephoto (T) end remains in focus when it is zoomed out to the wide angle (W) end.

Adjusting Brightness

You can adjust the brightness to your preferred level.

- 1 Select the Manual recording mode.

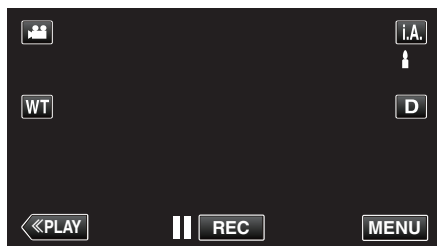

- If the mode is **i.A.** Intelligent Auto, tap **i.A.** on the recording screen to display the mode switching screen.

Tap **M** to switch the recording mode to Manual.

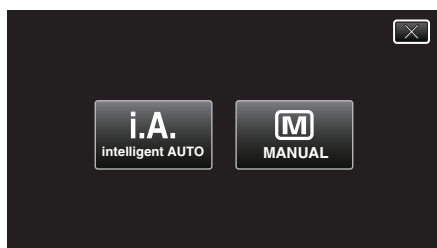

- 2 Tap "MENU".

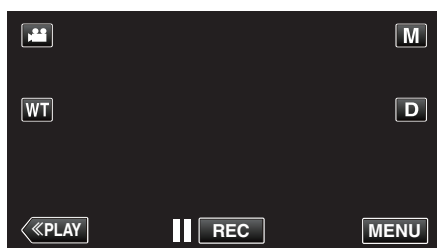

- The shortcut menu appears.

- 3 Tap "MENU" in the shortcut menu.

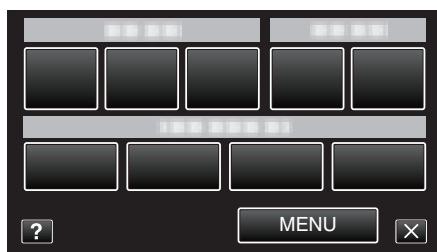

- 4 Tap "BRIGHTNESS ADJUST".

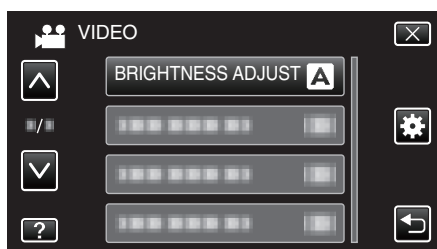

- Tap \wedge or \vee to move upward or downward for more selection.
- Tap \times to exit the menu.
- Tap \curvearrowright to return to the previous screen.

- 5 Tap "MANUAL".

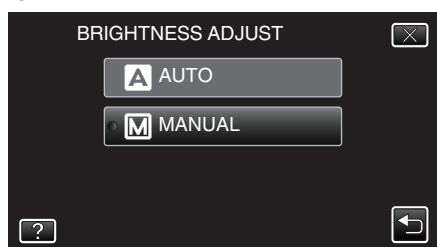

- 6 Adjust the brightness value.

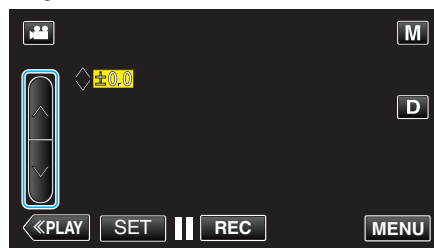

- Compensation range during video recording: -2.0 to +2.0
- Compensation range during still image recording: -2.0 to +2.0
- Tap \wedge to increase the brightness.
- Tap \vee to decrease the brightness.

- 7 Tap "SET" to confirm.

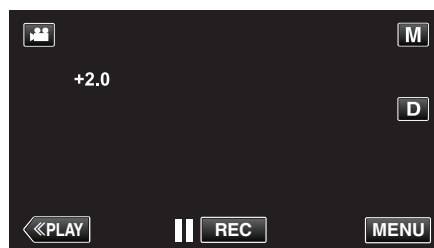

Memo :

- Settings can be adjusted separately for videos and still images.

Recording

Setting Shutter Speed

You can set the shutter speed to suit the type of subject.

1 Select the Manual recording mode.

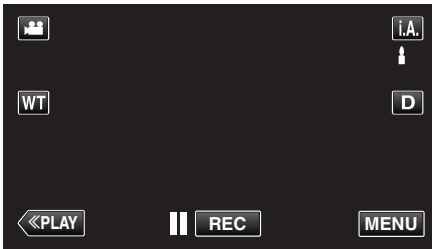

- If the mode is **i.A.**, Intelligent Auto, tap **i.A.** on the recording screen to display the mode switching screen. Tap **M** to switch the recording mode to Manual.

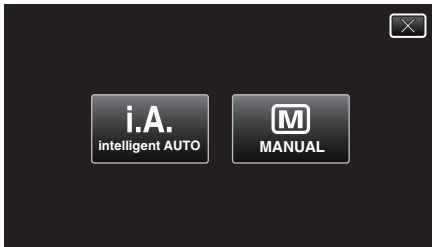

2 Tap "MENU".

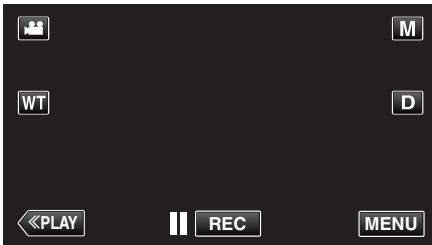

- The shortcut menu appears.

3 Tap "MENU" in the shortcut menu.

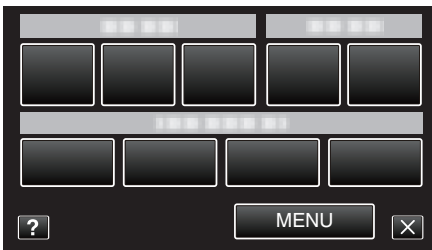

4 Tap "SHUTTER SPEED".

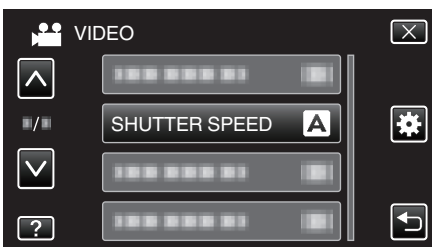

- Tap \wedge or \vee to move upward or downward for more selection.
- Tap \times to exit the menu.
- Tap \curvearrowright to return to the previous screen.

5 Tap "MANUAL".

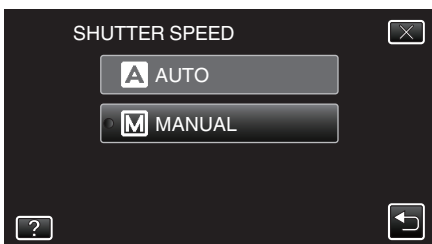

6 Adjust the shutter speed.

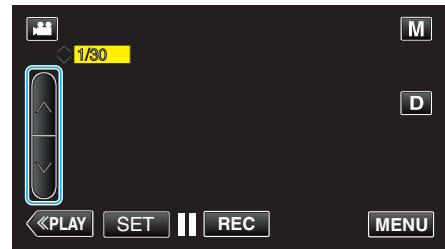

- Shutter speed can be set from 1/2 to 1/4000.
- Tap \wedge to increase the shutter speed.
- Tap \vee to decrease the shutter speed.

7 Tap "SET" to confirm.

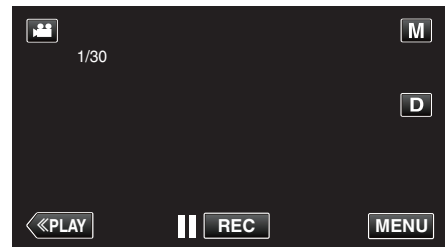

Memo :

- Settings can be adjusted separately for videos and still images.
- "SHUTTER SPEED" can only be set to a maximum of 1/125 when "FLASH" is not set to "OFF" in the still image recording mode.
- While fast-moving subjects can be captured clearly by increasing "SHUTTER SPEED", the screen may appear darker. When recording in dark places such as indoors, check the brightness of the LCD monitor and set "SHUTTER SPEED" accordingly.

Setting Aperture

You can adjust the aperture to change the area of focus.

- 1 Select the Manual recording mode.

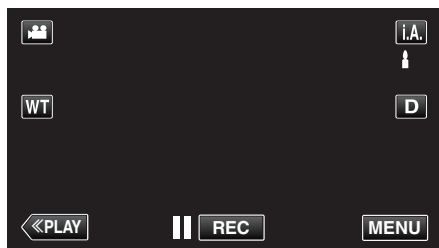

- If the mode is **i.A.** Intelligent Auto, tap **i.A.** on the recording screen to display the mode switching screen.

Tap **M** to switch the recording mode to Manual.

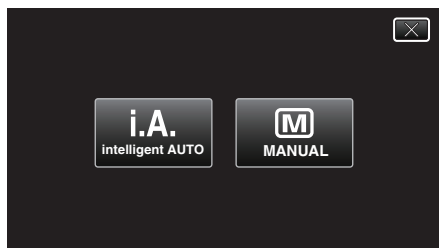

- 2 Tap "MENU".

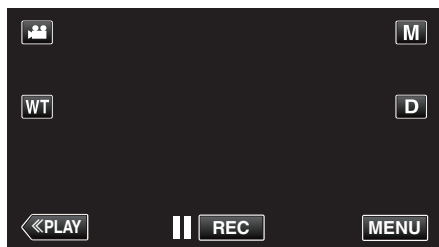

- The shortcut menu appears.

- 3 Tap "MENU" in the shortcut menu.

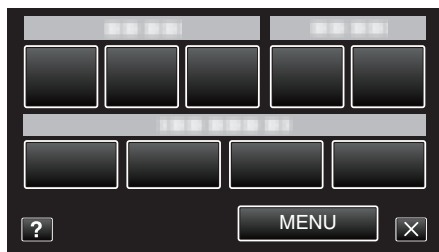

- 4 Tap "APERTURE PRIORITY".

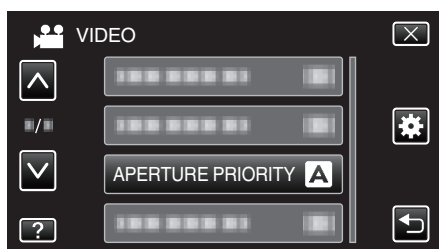

- Tap \wedge or \vee to move upward or downward for more selection.
- Tap \times to exit the menu.
- Tap \curvearrowright to return to the previous screen.

- 5 Tap "MANUAL".

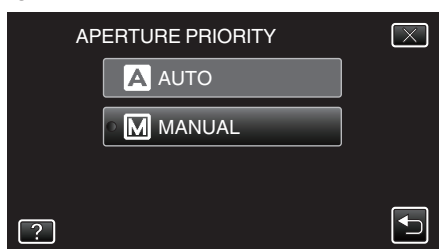

- 6 Adjust the aperture.



- Aperture can be set from F1.2 to F5.6.
- If you want the background to be in focus as well (larger aperture value), tap \wedge .
- If you want the background to appear blurry (smaller aperture value), tap \vee .

- 7 Tap "SET" to confirm.

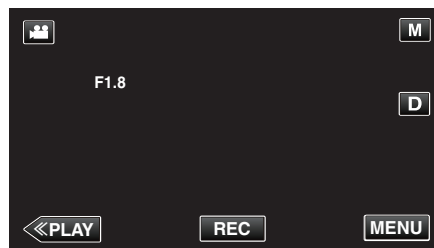

Memo :

- Settings can be adjusted separately for videos and still images.
- When zoomed to the telephoto end, the aperture value is set according to the zoom and indicated in yellow. Set the zoom to the wide angle end to enable the smallest F-number to be set.
- The larger the aperture value, the darker the subject may appear.

Recording

Setting White Balance

You can set the color tone to suit the light source.

- 1 Select the Manual recording mode.

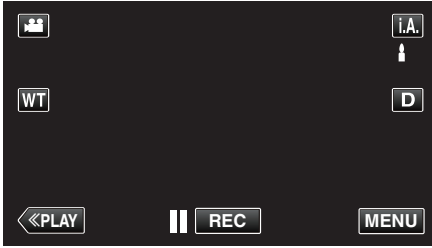

- If the mode is **i.A.**, Intelligent Auto, tap **i.A.** on the recording screen to display the mode switching screen. Tap **M** to switch the recording mode to Manual.



- 2 Tap "MENU".

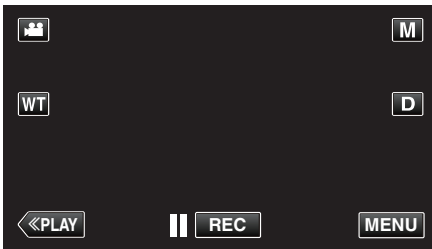

- The shortcut menu appears.

- 3 Tap "MENU" in the shortcut menu.

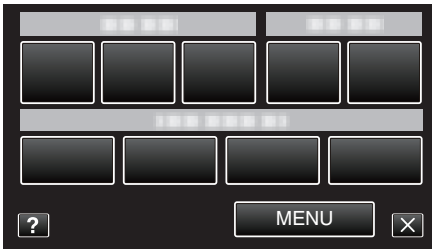

- 4 Tap "WHITE BALANCE".

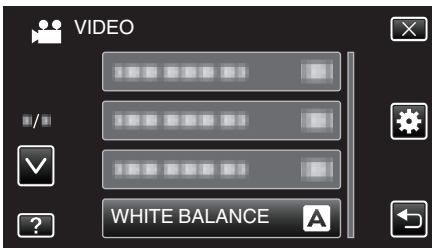

- Tap \wedge or \vee to move upward or downward for more selection.
- Tap \times to exit the menu.
- Tap \curvearrowright to return to the previous screen.

- 5 Tap the appropriate shooting environment.

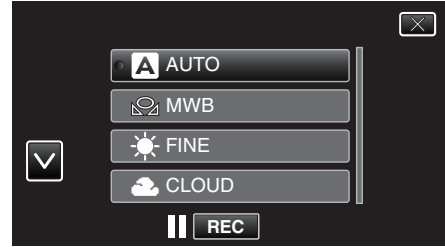

- Tap \wedge or \vee to move the cursor.

Setting	Details
AUTO	Adjusts automatically to the natural colors.
MWB	Use this when the problem of unnatural colors is not resolved.
FINE	Set this when shooting outdoors on a sunny day.
CLOUD	Set this when shooting on a cloudy day or inside a shade.
HALOGEN	Set this when shooting under illumination such as a video light.
MARINE:BLUE	Set this when shooting the sea at deep water area (water appears blue) using an optional marine case.
MARINE:GREEN	Set this when shooting the sea at shallow water area (water appears green) using an optional marine case.

Using MWB

- 1 Hold a sheet of plain white paper in front of the lens so that the white paper fills the screen.
- 2 Tap "MWB" and keep touching while the icon appears and blinks.
- 3 Release your touch after the menu disappears and MWB lights up.

Memo :

- The setting will not change if "MWB" is being tapped too fast (less than 1 second).

Setting Backlight Compensation

You can correct the image when the subject appears too dark due to backlight.

- 1 Select the Manual recording mode.

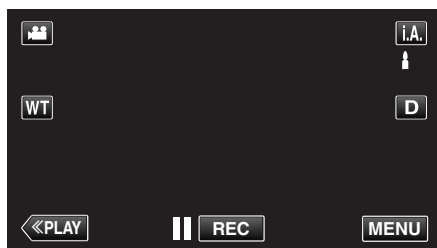

- If the mode is **i.A.** Intelligent Auto, tap **i.A.** on the recording screen to display the mode switching screen. Tap **M** to switch the recording mode to Manual.

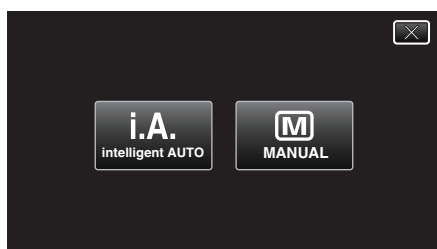

- 2 Tap "MENU".

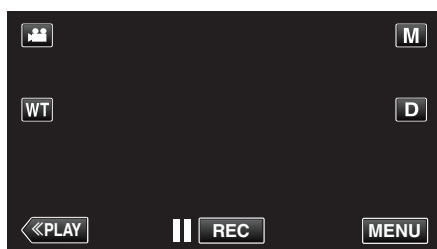

- The shortcut menu appears.

- 3 Tap "MENU" in the shortcut menu.

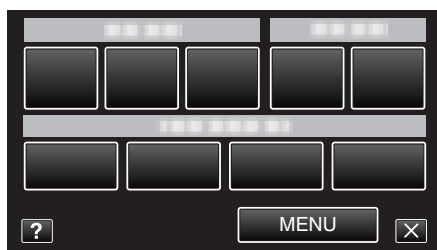

- 4 Tap "BACKLIGHT COMP.".

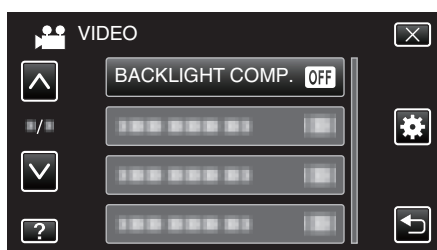

- Tap \wedge or \vee to move upward or downward for more selection.
- Tap \times to exit the menu.
- Tap \curvearrowright to return to the previous screen.

- 5 Tap "ON".

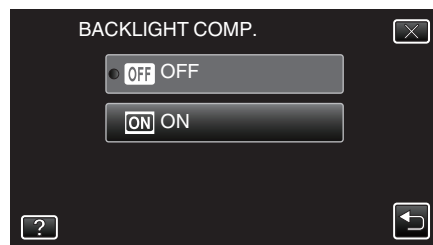

- After setting, the backlight icon  appears.

Recording

Checking for Overexposed Areas (ZEBRA)

During video recording, diagonal lines (zebra pattern) are displayed only at areas with the specified luminance levels.

- 1 Select the Manual recording mode.

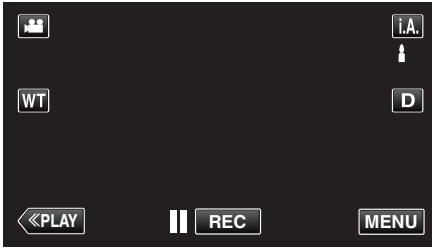

- If the mode is **i.A.**, Intelligent Auto, tap **i.A.** on the recording screen to display the mode switching screen. Tap **M** to switch the recording mode to Manual.

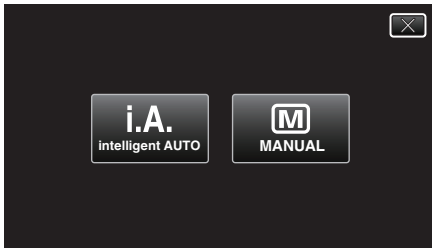

- 2 Tap "MENU".

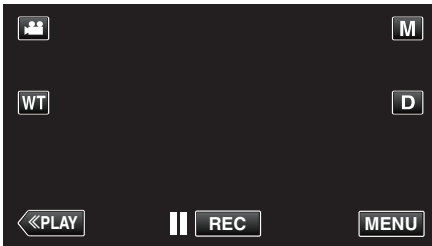

- The shortcut menu appears.

- 3 Tap "MENU" in the shortcut menu.

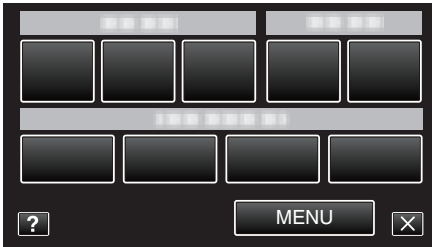

- 4 Tap "ZEBRA".

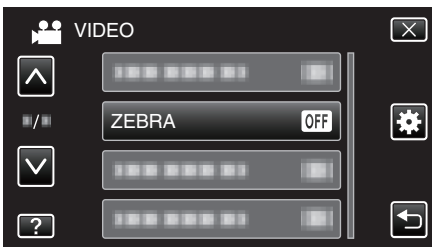

- Tap \wedge or \vee to move upward or downward for more selection.
- Tap \times to exit the menu.
- Tap \curvearrowright to return to the previous screen.

- 5 Tap "70-80%" or "OVER100%".

70-80%	Sections that are close to be overexposed are displayed in striped pattern.
OVER100%	Sections that are overexposed are displayed in striped pattern.

Setting	Details
OFF	Deactivates the function.

Taking Close-up Shots

You can take close-up shots of an object using the tele macro function.



*The image is only an impression.

- 1 Select the Manual recording mode.

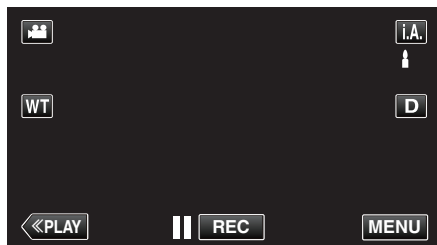

- If the mode is **i.A.** Intelligent Auto, tap **i.A.** on the recording screen to display the mode switching screen. Tap **M** to switch the recording mode to Manual.

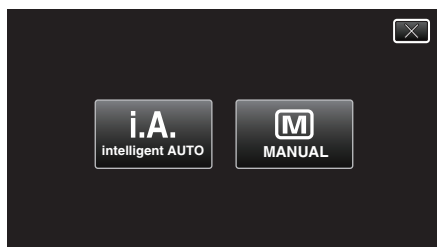

- 2 Tap "MENU".

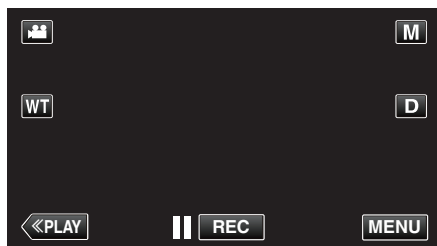

- The shortcut menu appears.

- 3 Tap "MENU" in the shortcut menu.

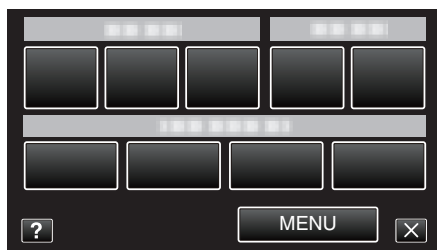

- 4 Tap "TELE MACRO".



- Tap \wedge or \vee to move upward or downward for more selection.
- Tap \times to exit the menu.
- Tap \leftarrow to return to the previous screen.

- 5 Tap "ON".

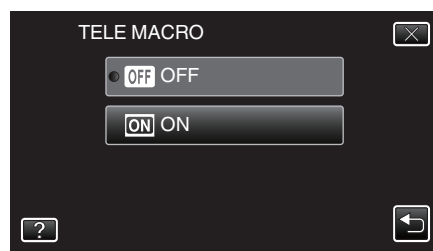

- After setting, the tele macro icon $\left[\text{M} \right]$ appears.

Setting	Details
OFF	Enables close-up shots up to 1 m at the telephoto (T) end. Enables close-up shots up to 5 cm at the wide angle (W) end.
ON	Enables close-up shots up to 60 cm at the telephoto (T) end. Enables close-up shots up to 5 cm at the wide angle (W) end.

Caution :

- When you are not taking close-up shots, set "TELE MACRO" to "OFF". Otherwise, the image may be blur.

Recording with Effects

You can add animation effects to video recordings. The animation effects appear when smiles are detected or when the screen is touched.

Type of Effect	Description of Effect
ANIMATION EFFECT	Records videos with animation effects. "Recording with Animation Effects" (p. 94)
DECORATE FACE EFFECT	Detects faces and enables decorations such as sunglasses to be added. "Recording with Face Decorations" (p. 96)
STAMP	Records videos with various decorative stamps. "Recording with Decorative Stamps" (p. 96)
HANDWRITING EFFECT	Records videos with your personal handwriting or drawing. "Recording with Personal Handwriting" (p. 97)

Recording with Animation Effects

You can add animation effects to video recordings. The animation effects appear when smiles are detected or when the screen is touched.

1 Open the LCD monitor.

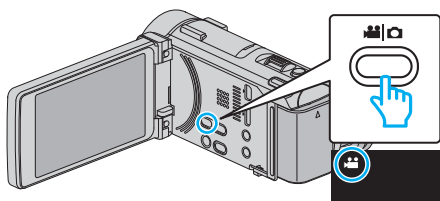

- Check if the recording mode is .
- If the mode is still image, tap on the recording screen to display the mode switching screen. Tap to switch the recording mode. (You can also use the button on this unit.)

2 Tap "MENU".

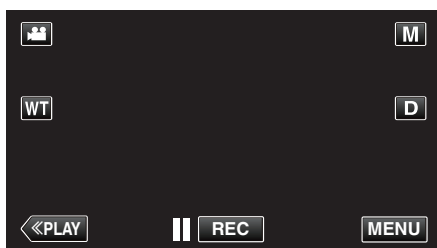

- The shortcut menu appears.

3 Tap "MENU". (Go to step 4.) Alternatively, tap "ANIMATION EFFECT" in the shortcut menu. (Go to step 5.)

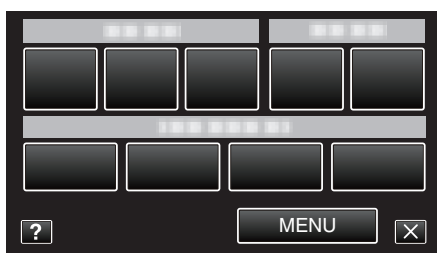

4 Tap "ANIMATION EFFECT".

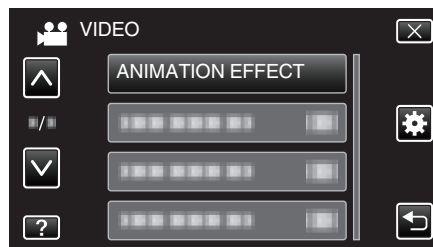





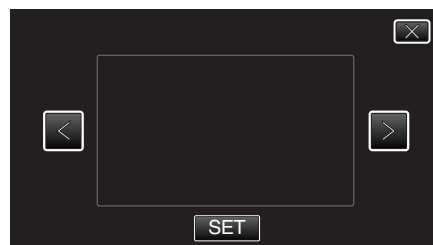

- Tap or to move upward or downward for more selection.
- Tap to exit the menu.
- Tap to return to the previous screen.

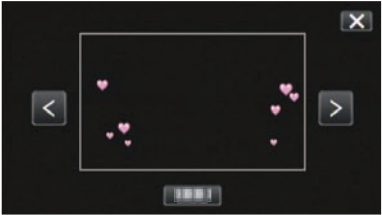
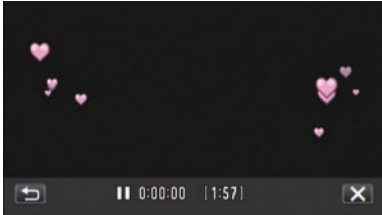
5 Select a desired effect and tap "SET".

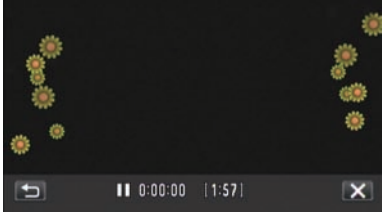

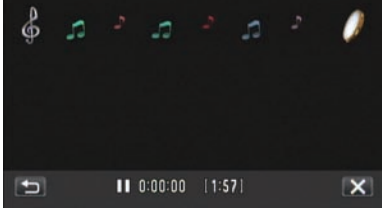
- Tap or to change the effect.
- Press the START/STOP button the camera to start recording. Press again to stop.
- To select another effect, tap .
- Tap to exit "ANIMATION EFFECT". (To perform operations other than recording, tap to cancel the "ANIMATION EFFECT" first.)

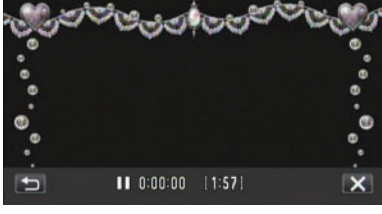
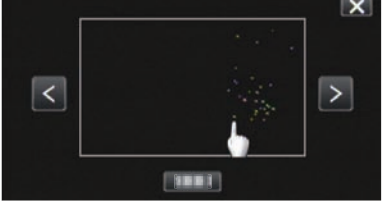
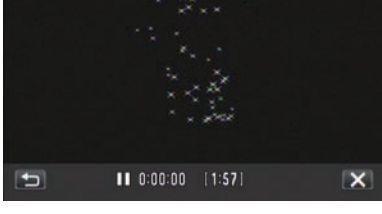
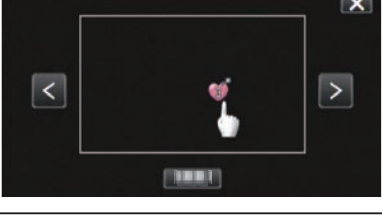
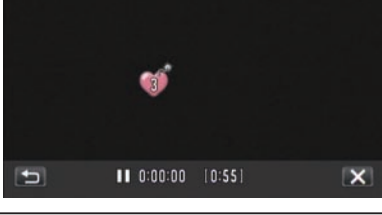
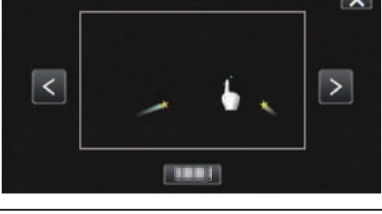
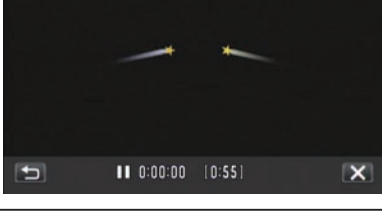
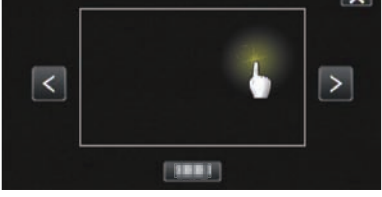
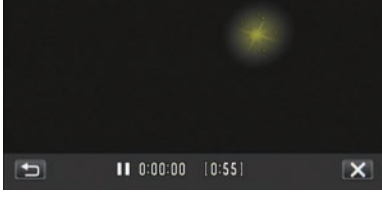
During Setting	After Setting	Note
		<p>Animation (effect) appears when smiles are detected.</p>
		<p>Animation (effect) appears when smiles are detected.</p>
		<p>Animation (effect) appears when smiles are detected.</p>
		<p>Animation (effect) appears when smiles are detected.</p>
		<p>Animation (effect) appears when the screen is touched.</p>
		<p>Animation (effect) appears when the screen is touched.</p>
		<p>Animation (effect) appears when the screen is touched.</p>
		<p>Animation (effect) appears when the screen is touched.</p>

Recording

Recording with Face Decorations

Detects faces and enables decorations such as sunglasses to be added.

- 1 Open the LCD monitor.

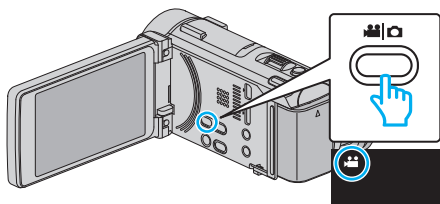

- Check if the recording mode is .
- If the mode is still image, tap on the recording screen to display the mode switching screen. Tap to switch the recording mode. (You can also use the button on this unit.)

- 2 Tap "MENU".

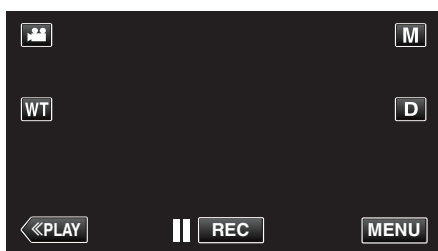

- The shortcut menu appears.

- 3 Tap "MENU". (Go to step 4.)

Alternatively, tap "DECORATE FACE EFFECT" () in the shortcut menu. (Go to step 5.)

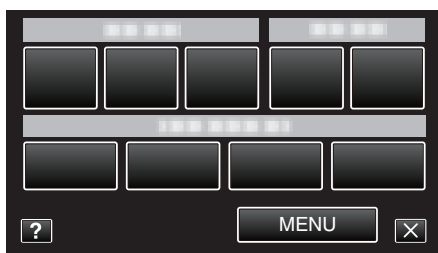

- 4 Tap "DECORATE FACE EFFECT".

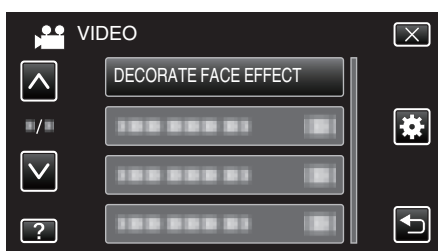

- Tap or to move upward or downward for more selection.
- Tap to exit the menu.
- Tap to return to the previous screen.

- 5 Select a desired effect and tap "SET".

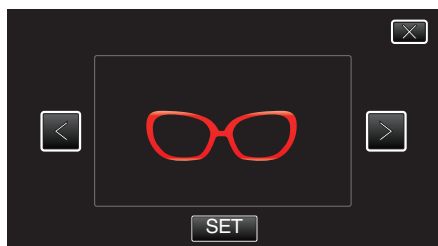

- Tap or to select an item.
- Press the START/STOP button the camera to start recording. Press again to stop.
- To select another effect, tap .
- Tap to exit "DECORATE FACE EFFECT".

(To perform operations other than recording, tap to cancel the "DECORATE FACE EFFECT" first.)

Recording with Decorative Stamps

Records videos with various decorative stamps.

- 1 Open the LCD monitor.

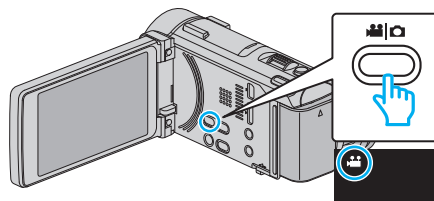

- Check if the recording mode is .
- If the mode is still image, tap on the recording screen to display the mode switching screen. Tap to switch the recording mode. (You can also use the button on this unit.)

- 2 Tap "MENU".

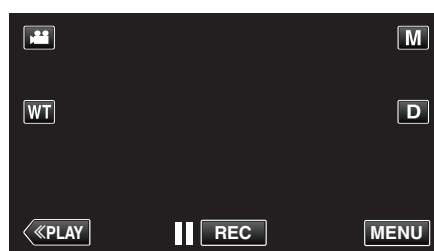

- The shortcut menu appears.

- 3 Tap "MENU". (Go to step 4.)

Alternatively, tap "STAMP" () in the shortcut menu. (Go to step 5.)

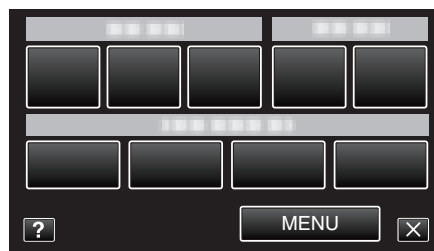

- 4 Tap "STAMP".

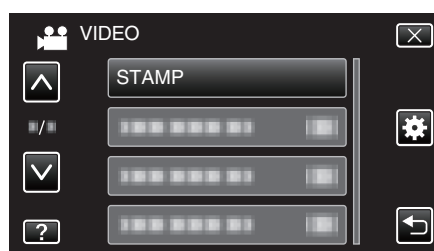

- Tap or to move upward or downward for more selection.
- Tap to exit the menu.
- Tap to return to the previous screen.

- 5 Select a stamp.

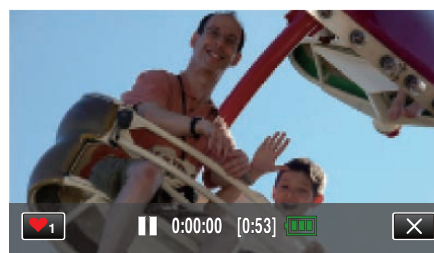

- Tap to start selecting a stamp. Tap on the desired stamp to use. The number indicates the size of the stamp.

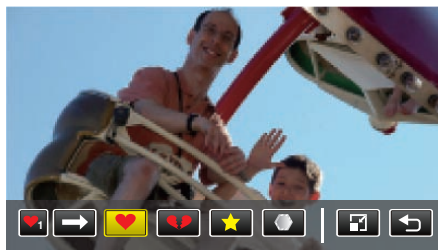

- Tap → to scroll through the list of stamps.
- Tap [] to change the size of stamps.
- Tap ↶ to return to the previous screen.

6 Tap on the screen to add a stamp.

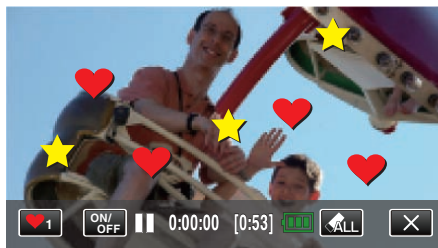

- Tap ALL to delete the stamp.
- Tap "ON/OFF" to display/hide the stamps.
- Press the START/STOP button the camera to start recording. Press again to stop.
- Tap X to exit "STAMP".
(To perform operations other than recording, tap X to cancel the "STAMP" first.)

Memo :

- Up to 50 stamps may be added.
- The added stamps are deleted when the stamp mode ends or when power is turned off.

Recording with Personal Handwriting

Records videos with your personal handwriting or drawing.

1 Open the LCD monitor.

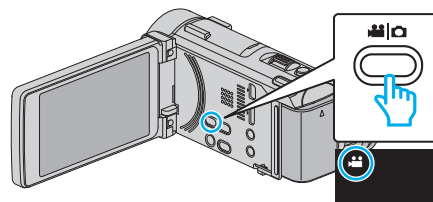

- Check if the recording mode is [].
- If the mode is [] still image, tap [] on the recording screen to display the mode switching screen. Tap [] to switch the recording mode. (You can also use the [] button on this unit.)

2 Tap "MENU".

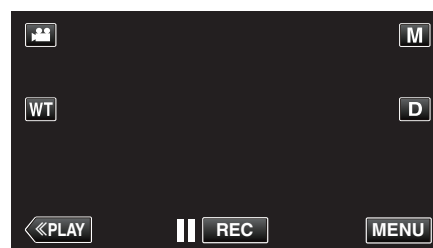

- The shortcut menu appears.

3 Tap "MENU". (Go to step 4.)
Alternatively, tap "HANDWRITING EFFECT" (ا) in the shortcut menu. (Go to step 5.)

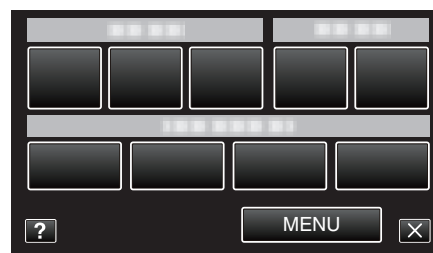

4 Tap "HANDWRITING EFFECT".

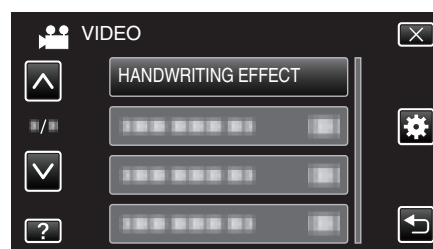





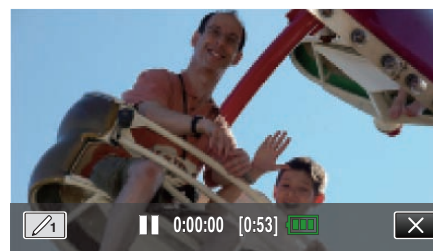

- Tap ^ or v to move upward or downward for more selection.
- Tap X to exit the menu.
- Tap ↶ to return to the previous screen.

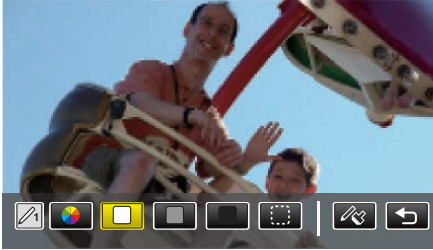
5 Select a line.







- Tap [] to select the line color and thickness. The number indicates the thickness of the line.

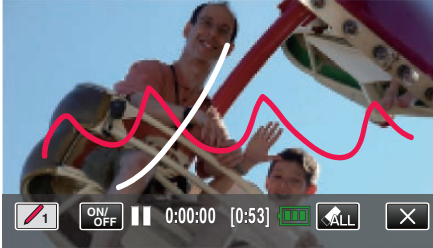

- You can select a color from white, gray, black, etc.
- Select  to tap and erase part of the line.
- Tap  to select the line color.
Tap  to scroll through the list of colors.
- Tap  to select the line thickness.
- Tap  to return to the previous screen.

6 Start writing and drawing with the provided stylus.



- Tap  to delete all the lines.
- Tap "ON/OFF" to display/hide the lines.
- Press the START/STOP button the camera to start recording.
Press again to stop.
- Tap  to exit "HANDWRITING EFFECT".
(To perform operations other than recording, tap  to cancel the "HANDWRITING EFFECT" first.)

Memo :

- If the writings and drawings appear to be misaligned, correct the touch position.
- "TOUCH SCREEN ADJUST" (☞ p. 202)
- The writings and drawings are deleted when the handwriting mode ends or when the power is turned off.
-

Capturing Subjects Clearly (TOUCH PRIORITY AE/AF)

“TOUCH PRIORITY AE/AF” is a function that adjusts focus and brightness based on a tapped position.

By registering the face of a person beforehand, you can enable tracking of the person even without specific selection during recording.

This function is available for both videos and still images.

- 1 Open the LCD monitor.

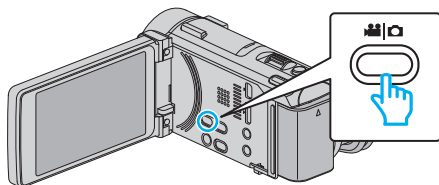

- Set the recording mode to either video or still image.
- To switch the mode between video and still image, tap or on the recording screen to display the mode switching screen. Tap or to switch the mode to video or still image respectively. (You can also use the / button on this unit.)

- 2 Tap “MENU”.

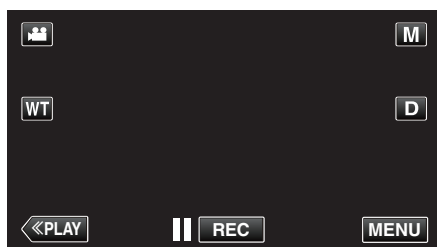

- The shortcut menu appears.

- 3 Tap “MENU” in the shortcut menu.

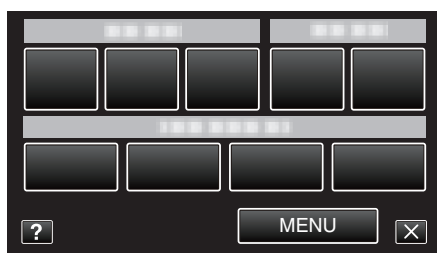

- 4 Tap “TOUCH PRIORITY AE/AF”.



- Tap or to move upward or downward for more selection.
- Tap to exit the menu.
- Tap to return to the previous screen.

- 5 Tap the desired setting.

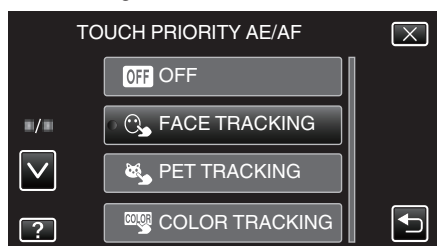

FACE TRACKING

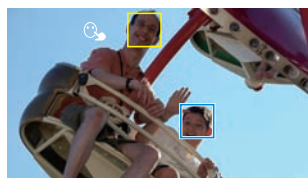

COLOR TRACKING

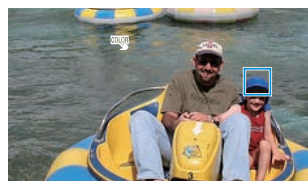

PET TRACKING

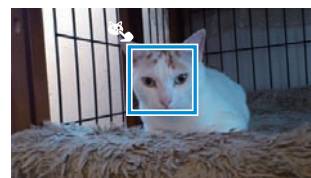

AREA SELECT

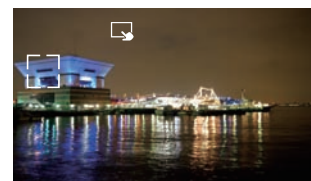

- Focus and brightness will be adjusted automatically based on the tapped position (face/color/area). A blue frame appears around the selected subject (face/color), while a white frame appears around the selected area.
- To reset, tap the desired position (face/color/area) again.
- To cancel “FACE TRACKING” or “COLOR TRACKING”, tap the blue frame.
- To cancel “AREA SELECT”, tap the white frame.

Setting	Details
OFF	Deactivates the function.
FACE TRACKING	appears on the screen. Recording is performed while tracking and automatically adjusting the tapped face (subject) with appropriate focus and brightness. In addition, a blue frame appears around the tapped face (subject). (When the face of a person is registered, it becomes the main subject and the blue frame appears even without specific selection.)
PET TRACKING	appears on the screen. Recording is performed while tracking and automatically adjusting the face of the tapped pet (subject) with appropriate brightness. In addition, a blue frame appears around the tapped pet (subject).
COLOR TRACKING	appears on the screen. Recording is performed while tracking and automatically adjusting the tapped color (subject) with appropriate focus and brightness. In addition, a blue frame appears around the tapped color (subject).
AREA SELECT	appears on the screen. Recording is performed while automatically adjusting the tapped area (fixed position) with appropriate focus and brightness. In addition, a white frame appears around the tapped area.

Memo :

- When “TOUCH PRIORITY AE/AF” is set, “FOCUS” will be set to “AUTO” automatically.
- Tap the selected position (face/color/area) again to cancel the setting. (Setting remains for registered faces.)
- Tap on an unselected position (face/color/area) to reset.
- If the camera loses track of a subject, tap the subject again.
- Settings are canceled when zoom operation is performed. (“AREA SELECT” only)
- When “FACE TRACKING” is set after face registration, the blue frame appears around the face with the highest priority registered.
- When recording registered faces using “FACE TRACKING”, focus and brightness will be adjusted automatically even without specific selection. In addition, registered faces may be tracked back again even if they are lost. Therefore, it is recommended to register the faces that are often being recorded by this camera beforehand.

“Registering Human Face Personal Authentication Information”
(p. 105)

- When “COLOR TRACKING” is set, the targeted subject (color) may change if similar colors are detected. In this case, tap the subject again.

The targeted subject (color) may also be tracked back again if it appears in the center of the screen within a specific time.

Caution :

- Subjects near the sides of the LCD monitor may not respond or be recognized when tapped. In this case, move the subject to the center and tap again.
- “FACE TRACKING” may not work properly depending on the shooting conditions (distance, angle, brightness, etc.) and the subject (direction of face, etc.). It is also particularly difficult to detect faces in backlight.
- “PET TRACKING” may not work properly depending on the type of pet, shooting conditions (distance, angle, brightness, etc.) and the subject (direction of face, etc.). It is also particularly difficult to detect faces of pets that are totally black, covered in long hair, or in backlight.
- “COLOR TRACKING” may not function properly in the following cases:
 - when recording subjects with no contrast
 - when recording subjects that are moving at high speed
 - when recording in a dark place
 - when the surrounding brightness changes
- When “FACE TRACKING” is set, the subject may be lost if the camera is moved vertically or horizontally very fast. For unregistered faces, they cannot be tracked back again. To track back the subject, tap on it again. For registered faces, focus and brightness will be adjusted automatically even without specific selection. In addition, registered faces may be tracked back again even if they are lost. Therefore, it is recommended to register the faces that are often being recorded by this camera beforehand.

“Registering Human Face Personal Authentication Information”
(p. 105)

Capturing Smiles Automatically (SMILE SHOT)

“SMILE SHOT” automatically captures a still image upon detection of a smile.

This function is available for both videos and still images.

Set “TOUCH PRIORITY AE/AF” to “FACE TRACKING” before selecting “SMILE SHOT”.

“Capturing Subjects Clearly (TOUCH PRIORITY AE/AF)” (p. 99)

1 Open the LCD monitor.

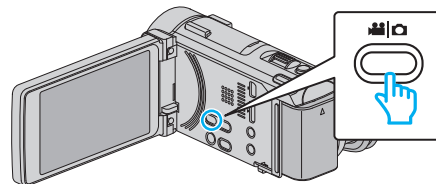

- Set the recording mode to either video or still image.
- To switch the mode between video and still image, tap or on the recording screen to display the mode switching screen. Tap or to switch the mode to video or still image respectively. (You can also use the button on this unit.)

2 Tap “MENU”.

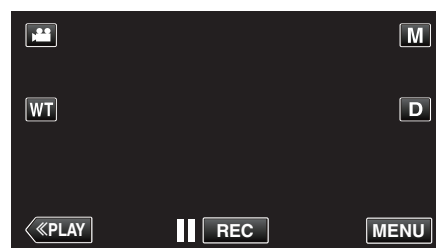

- The shortcut menu appears.

3 Tap “MENU”. (Go to step 4.)

Alternatively, tap “SMILE SHOT”() in the shortcut menu. (Go to step 5.)

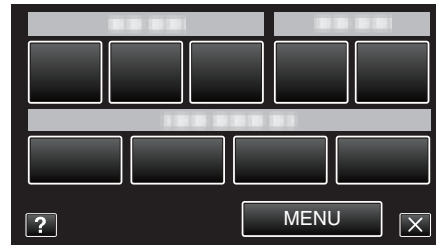

4 Tap “SMILE SHOT”.

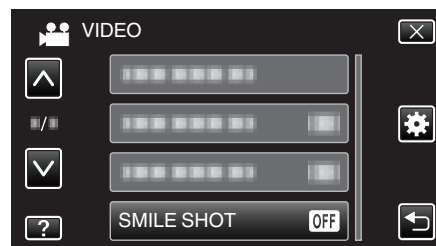

- Tap or to move upward or downward for more selection.
- Tap to exit the menu.
- Tap to return to the previous screen.

5 Tap “ON”.

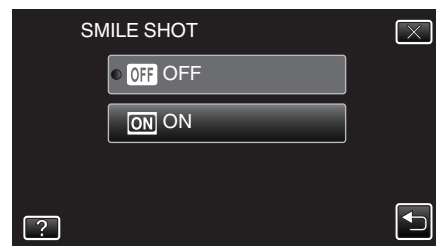

- Tap to exit the menu as the previous screen appears.

6 Point the camera toward the human subject.

- A still image is automatically captured when smiles are detected.

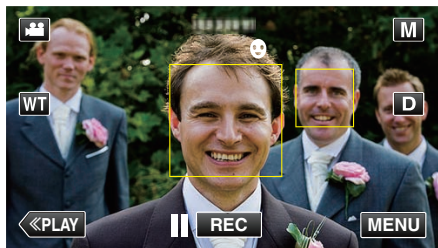

- PHOTO lights up when a still image is being captured.
- You can display the name and smile level (%) together with the frame by setting "SMILE%/NAME DISPLAY" in the menu to "ON" before recording.

"Setting SMILE%/NAME DISPLAY" (☞ p. 107)

Memo : _____

- The camera is able to detect up to 16 faces. Smile levels will be displayed for up to 3 of the largest faces displayed on the screen.
- This function may not work properly depending on the shooting conditions (distance, angle, brightness, etc.) and the subject (direction of face, smile level, etc.). It is also difficult to detect a smile in backlight.
- After a smile is detected and captured, it takes time before the next recording may be performed.
- "SMILE SHOT" does not work in the following cases:
 - when menu is being displayed
 - when remaining recording time or battery power is being displayed
 - when "FACE SUB-WINDOW" is set
 - when "ANIMATION EFFECT" is set
 - when "DECORATE FACE EFFECT" is set
 - when "STAMP" is set
 - when "HANDWRITING EFFECT" is set
 - when "AUTO REC" is set
 - when "DATE/TIME RECORDING" is set

"Recording while Displaying a Magnified View of a Selected Face (FACE SUB-WINDOW)" (☞ p. 103)

"Recording with Animation Effects" (☞ p. 94)

Caution : _____

- If "TOUCH PRIORITY AE/AF" is not set to "FACE TRACKING", "SMILE SHOT" will not work.
- If appropriate results cannot be obtained, record with "SMILE SHOT" set to "OFF".

Recording

Capturing Pets Automatically (PET SHOT)

“PET SHOT” automatically captures a still image upon detection of the face of a pet, such as dogs or cats.

This function is available for both videos and still images.

1 Open the LCD monitor.

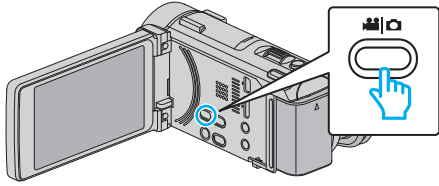

- Set the recording mode to either video or still image.
- To switch the mode between video and still image, tap or on the recording screen to display the mode switching screen. Tap or to switch the mode to video or still image respectively. (You can also use the / button on this unit.)

2 Tap “MENU”.

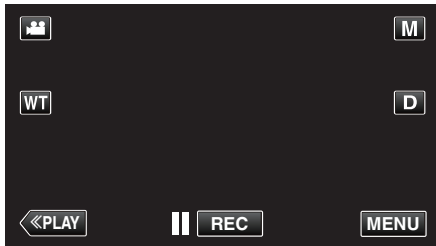

- The shortcut menu appears.

3 Tap “MENU” in the shortcut menu.

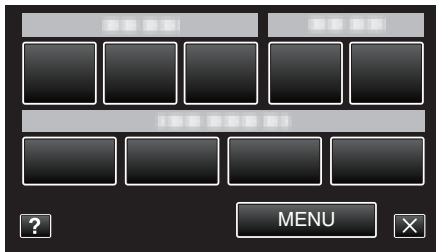

4 Tap “PET SHOT”.



- Tap or to move upward or downward for more selection.
- Tap to exit the menu.
- Tap to return to the previous screen.

5 Tap “ON”.

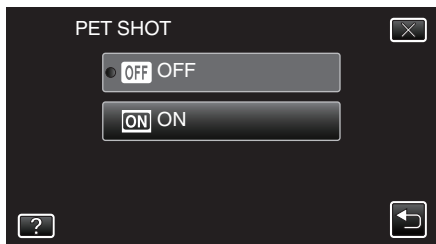

- Tap to exit the menu as the previous screen appears.

6 Point the camera toward the pet.

- A still image is automatically captured when faces of pets are detected.

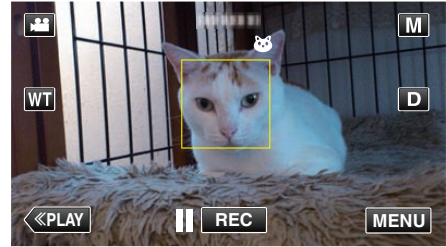

- PHOTO lights up when a still image is being captured.

Memo :

- The camera is able to detect up to 6 faces of pets.
- “PET SHOT” may not work properly depending on the type of pet, shooting conditions (distance, angle, brightness, etc.) and the subject (direction of face, etc.). It is also particularly difficult to detect faces of pets that are totally black, covered in long hair, or in backlight.
- Subjects other than your pet may be detected by mistake sometimes. Make use of “PET SHOT” only for pets such as dogs or cats.
- After a pet is detected and captured, it takes time before the next recording may be performed.
- “PET SHOT” does not work in the following cases:
 - when menu is being displayed
 - when remaining recording time or battery power is being displayed
 - when “FACE SUB-WINDOW” is set
 - when “ANIMATION EFFECT” is set
 - when “DECORATE FACE EFFECT” is set
 - when “STAMP” is set
 - when “HANDWRITING EFFECT” is set
 - when “AUTO REC” is set
 - when “DATE/TIME RECORDING” is set

“Recording while Displaying a Magnified View of a Selected Face (FACE SUB-WINDOW)” (p. 103)

“Recording with Effects” (p. 94)

Caution :

- When “PET SHOT” is set to “ON”, “TOUCH PRIORITY AE/AF” will be set to “PET TRACKING” automatically. Even when “PET SHOT” is set to “ON”, if “TOUCH PRIORITY AE/AF” is not set to “PET TRACKING”, “PET SHOT” will be set to “OFF” automatically.
- If appropriate results cannot be obtained, record with “PET SHOT” set to “OFF”.

Recording while Displaying a Magnified View of a Selected Face (FACE SUB-WINDOW)

You can record while viewing both the overall image of the scene and magnified image of a subject’s expression. Frames appear around the faces that can be magnified. Tap a frame to track and magnify the face in a sub-window.

- 1 Open the LCD monitor.

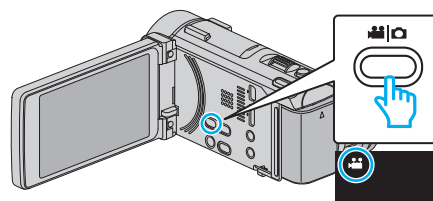

- Check if the recording mode is .
- If the mode is still image, tap on the recording screen to display the mode switching screen. Tap to switch the mode to video. (You can also use the button on this unit.)

- 2 Tap “MENU”.

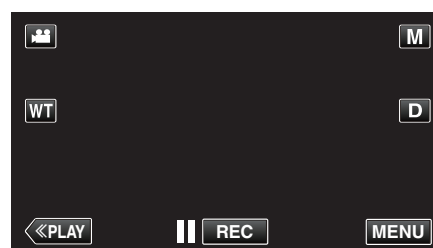

- The shortcut menu appears.

- 3 Tap “MENU” in the shortcut menu.

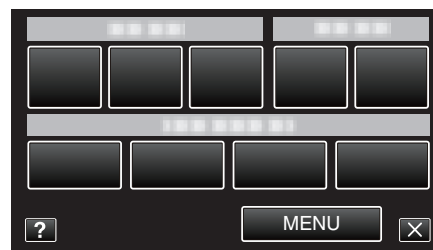

- 4 Tap “FACE SUB-WINDOW”.

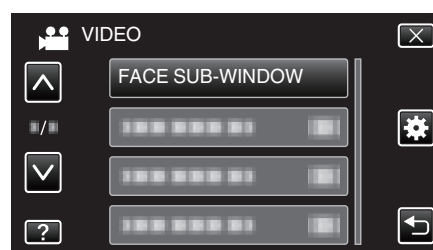

- 5 Tap on the frame of the face to magnify.

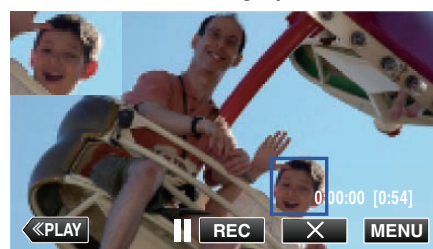

- When the face within a frame is tapped, it is displayed in a sub-window. The display position of the sub-window is set automatically according to the position of the tapped face.
- The frame of the tapped face changes to blue.
- When the tapped face disappears from the screen, the sub-window disappears too. When the face reappears on the screen., the sub-window is displayed again automatically.

- To exit "FACE SUB-WINDOW", tap "X".

Caution :

- Take note of the following when "FACE SUB-WINDOW" is set.
 - Functions such as digital zoom, zoom operation on the touch screen, simultaneous still image recording, "TIME-LAPSE RECORDING", "HIGH SPEED RECORDING", "DECORATE FACE EFFECT", "STAMP", "HANDWRITING EFFECT", "DATE/TIME RECORDING", "AUTO REC", and "HEADPHONE VOL. ADJ." are not available.
 - Settings such as "FOCUS" and "BRIGHTNESS ADJUST" are set to "AUTO" automatically.
 - If "TOUCH PRIORITY AE/AF" is set to FACE TRACKING, appropriate focus and brightness will be adjusted for the person displayed in the sub-window.
 - "ANIMATION EFFECT" is not available.
- The sub-window display will also be recorded.

Memo :

- When a face is magnified and displayed in the sub-window, only the name of the person will be displayed. (When a face is not registered, the name of the person will not be displayed.)
- The face sub-window mode is canceled when the power is turned off.
- Frames do not appear around the faces in the face sub-window mode as easily as in the other modes. They appear around the faces that can be magnified only. The frames do not appear in the following cases:
 - when the face of the subject is extremely small
 - when the surrounding is too dark or too bright
 - when the face appears horizontal or slanted
 - when the face appears bigger than the sub-window (such as when it is zoomed in)
 - when a part of the face is hidden

"Registering Human Face Personal Authentication Information"

( p. 105)

Registering Human Face Personal Authentication Information

By registering the face of a person beforehand, focus and brightness can be adjusted automatically by the face tracking function. Up to 3 faces, together with names and priority levels, can be registered.

It is recommended to register the faces that are often being recorded by this camera beforehand.

1 Open the LCD monitor.

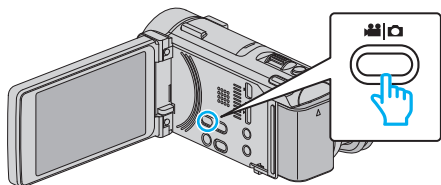

- Set the recording mode to either video or still image.
- To switch the mode between video and still image, tap or on the recording screen to display the mode switching screen. Tap or to switch the mode to video or still image respectively. (You can also use the / button on this unit.)

2 Tap "MENU".

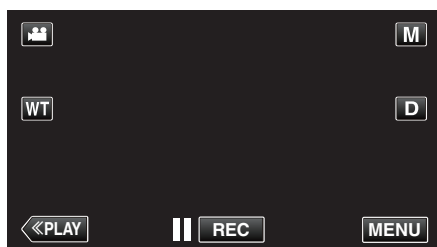

- The shortcut menu appears.

3 Tap "MENU" in the shortcut menu.

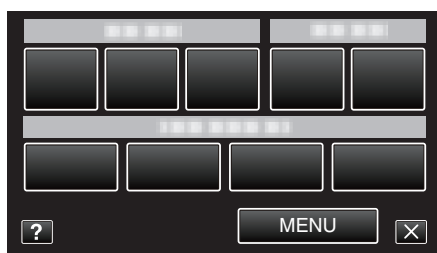

4 Tap "FACE REGISTRATION".

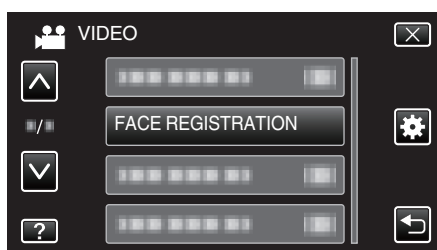

- Tap or to move upward or downward for more selection.
- Tap to exit the menu.
- Tap to return to the previous screen.

5 Tap "REGISTER NEW FACE".

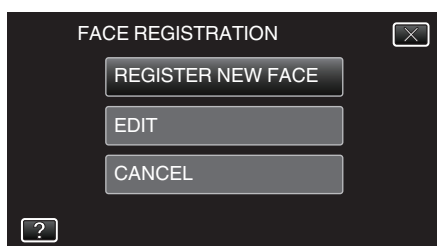

6 Point the camera toward the human subject.

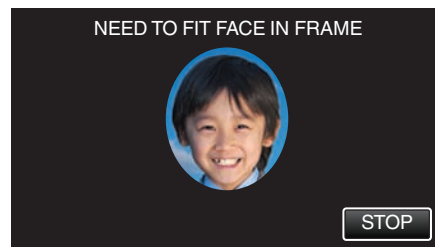

- Information is collected before face registration recording. The frame appears blinking while information is being collected.
- Adjust to fit the face within the frame while it is blinking. The frame stops blinking and lights up after information collection is complete.
- To cancel the registration, tap "STOP". When "CANCEL FACE RECOGNITION?" appears, tap "YES" to return to the normal recording mode.

7 Tap "RECORD" and record the face from the front.

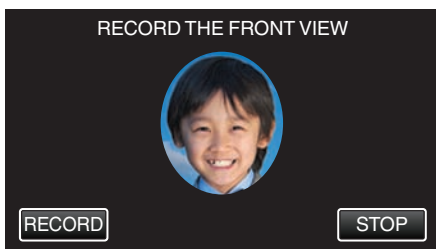

- A face is captured to be used on the face registration index screen.
- Other than tapping "RECORD", you can also record by pressing the SNAPSHOT button fully.
- A sound can be heard when recording is complete.
- To cancel the registration, tap "STOP". When "CANCEL FACE RECOGNITION?" appears, tap "YES" to return to the normal recording mode.

8 Tap "YES" to continue recording.

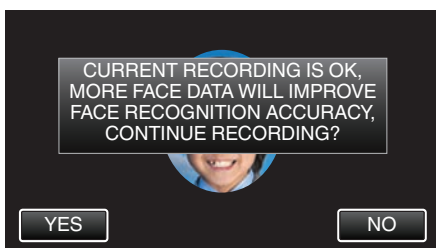

- To proceed to collect face information in the four directions of up, down, left, and right, tap "YES". It is recommended to continue recording to increase the accuracy of face recognition.
- To end face registration recording, tap "NO". Go to step 11.

9 Rotate the face slowly in four directions to register the face information.

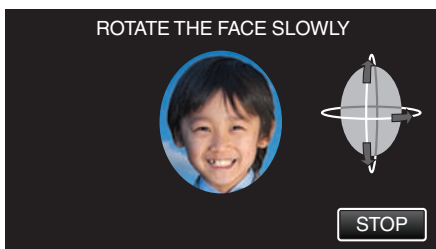

- Rotate the face slowly while looking at the camera. A sound can be heard when recording is complete for each direction. (4 times in total) Repeat the step until recording (registration) is complete for all directions.
- Registration of the four directions may fail depending on the shooting environment. In this case, tap "STOP" to cancel recording, then tap "NO" and go to step 11.
- If the face cannot be properly recognized during recording, register the face again.

10 Face the camera with a smiling face.

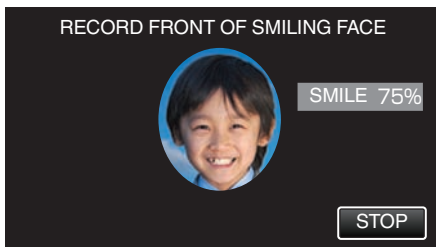

- Recording starts automatically. Using the smile % display as a reference, smile such that the value is as high as possible.
- A sound can be heard when recording is complete.
- To cancel recording of smiling face and proceed to enter a name, tap "STOP", then tap "NO" and go to step 11.

11 Tap "OK".

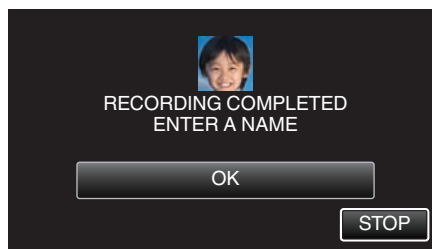

- Tapping "OK" registers the recorded face and the screen for entering a name appears.
- To cancel the registration, tap "STOP". When "CANCEL FACE RECOGNITION?" appears, tap "YES" to return to the normal recording mode.

12 Tap on the on-screen keyboard to enter a name, then tap "REG.".

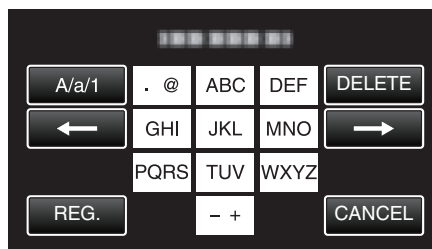

- Tap "DELETE" to delete a character.
- Tap "CANCEL" to exit.
- Tap "A/a/1" to select character input type from upper case letter, lower case letter, and number.
- Tap ← or → to move one space to the left or right.
- Up to 8 characters can be entered.
- How to input characters
Example: To enter "KEN"
Tap "JKL" 2 times → Tap "DEF" 2 times → Tap "MNO" 2 times

13 Tap the desired priority level, then tap "REG.".

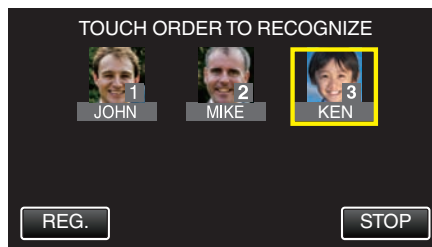

- Upon registration, the last number is assigned as the priority level. During face detection, the subject with the highest priority (lowest number) will be detected.
- You can change the priority level of a subject by tapping on the number.
Example: To change the priority level of number 3 to number 1, tap number 1. The priority level of the registered subject becomes number 1, while the priority levels of the original number 1 and the ones below drop by one place. (In this example, the original number 1 becomes number 2, and the original number 2 becomes number 3.)
- When "REG." is tapped, the registration complete screen appears.

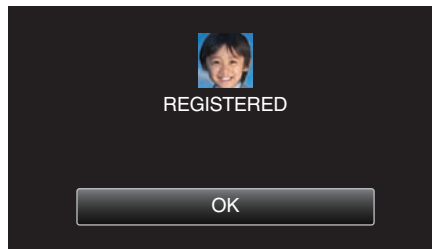

- Tap "OK" to complete the registration.
- You can edit registered face information in "EDIT". "Editing the Registered Face Information" (p. 108)

Memo : _____

- Faces may not be registered correctly in the following cases:
 - when the face appears either too small or too large compared to the frame
 - when it is too dark or too bright
 - when the face appears horizontal or slanted
 - when a part of the face is hidden
 - when there are multiple faces within the frame
- To increase the accuracy of face recognition, fit only one face within the frame and register in a bright environment.
- Faces may not be recognized correctly depending on the shooting conditions and environment. In this case, register the face again.
- Faces may not be recognized correctly during recording if the face recognition level is low. In this case, register the face again.
- Face tracking, face sub-window, and name display may not work properly depending on the registered faces, shooting conditions (distance, angle, brightness, etc.), and expressions.
- Face tracking, face sub-window, and name display may not work properly for people with similar facial features, such as siblings, parents, children, etc.

Setting SMILE%/NAME DISPLAY

“SMILE%/NAME DISPLAY” allows you to set the items to display when faces are detected.

This item is only displayed when “TOUCH PRIORITY AE/AF” is set to “FACE TRACKING”.

“Capturing Subjects Clearly (TOUCH PRIORITY AE/AF)” (p. 99)

- 1 Open the LCD monitor.

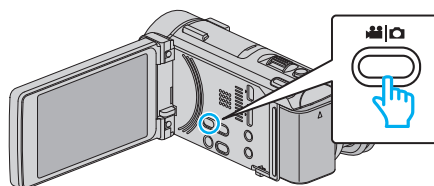

- Set the recording mode to either video or still image.
- To switch the mode between video and still image, tap or on the recording screen to display the mode switching screen. Tap or to switch the mode to video or still image respectively. (You can also use the / button on this unit.)

- 2 Tap “MENU”.

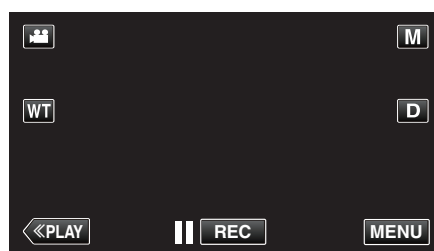

- The shortcut menu appears.

- 3 Tap “MENU”. (Go to step 4.)
Alternatively, tap “SMILE%/NAME DISPLAY” () in the shortcut menu. (Go to step 5.)

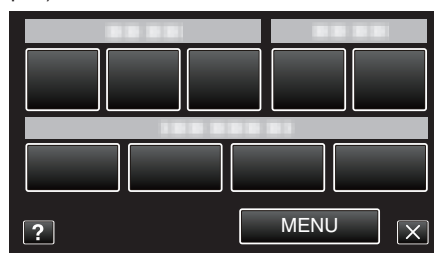

- 4 Tap “SMILE%/NAME DISPLAY”.



5 Tap the desired setting.

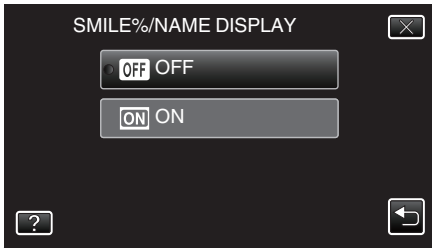

Setting	Details
OFF	Displays only the frames when faces are detected.
ON	Displays the frames, names, and smile levels (%) when faces are detected.

- Frame: Appears around detected faces.
- Name: Appears for faces that are registered.
- Smile level: Appears in value (0 % - 100 %) for detected smiles.



Memo :

- The camera is able to detect up to 16 faces. Smile levels will be displayed for up to 3 of the largest faces displayed on the screen.
 - Some faces may not be detected depending on the shooting environment.
 - You can register personal authentication information like face, name, and priority level of person before recording.
 - Up to 3 registered names will be displayed according to the priority level.
- “Registering Human Face Personal Authentication Information” (p. 105)
- “SMILE%/NAME DISPLAY” is set to “ON” when the demo mode is activated.
- “DEMO MODE” (p. 201)

Editing the Registered Face Information

Editing Registered Face Information

You can change the name, priority level, and face information that are registered.

1 Tap “MENU”.

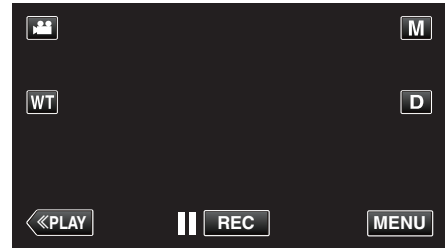

- The shortcut menu appears.

2 Tap “MENU” in the shortcut menu.

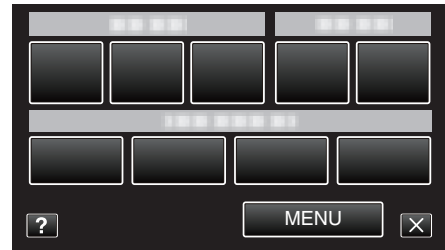

3 Tap “FACE REGISTRATION”.

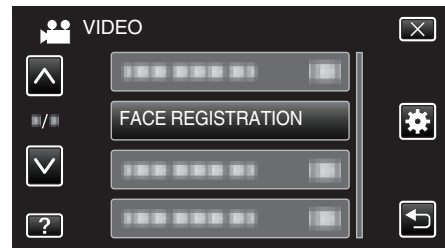

- Tap ^ or v to move upward or downward for more selection.
- Tap X to exit the menu.
- Tap ↶ to return to the previous screen.

4 Tap “EDIT”.

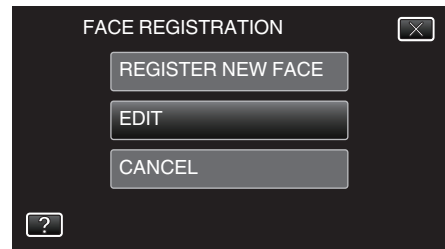

5 Tap the person to edit.

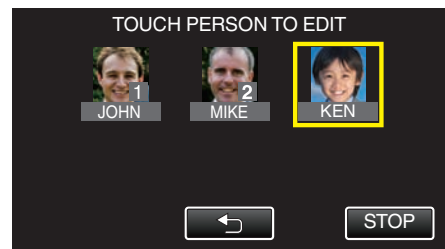

6 Tap the item to edit.

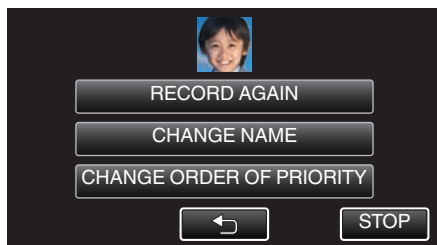

- If you select “RECORD AGAIN”, proceed to step 6 in ““Registering Human Face Personal Authentication Information” (p. 105) ”.
- If you select “CHANGE NAME”, proceed to step 12 in ““Registering Human Face Personal Authentication Information” (p. 106) ”.
- If you select “CHANGE ORDER OF PRIORITY”, proceed to step 13 in ““Registering Human Face Personal Authentication Information” (p. 106) ”.

“Registering Human Face Personal Authentication Information”
(p. 105)

Canceling (Deleting) Registered Face Information

You can cancel (delete) the face information that is registered.

- 1 Tap “MENU”.

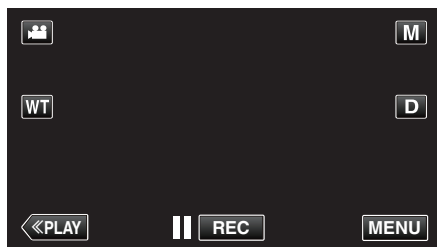

- The shortcut menu appears.

- 2 Tap “MENU” in the shortcut menu.

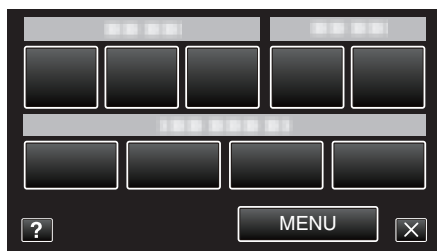

- 3 Tap “FACE REGISTRATION”.

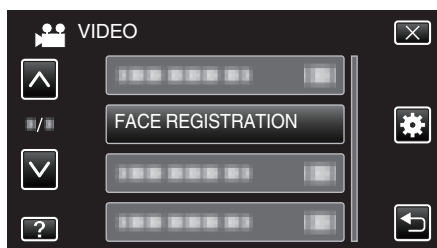

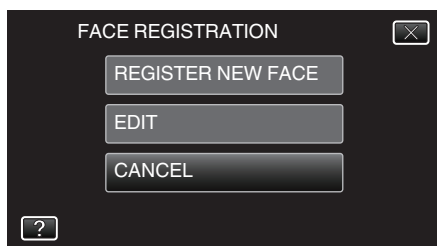

- Tap ^ or v to move upward or downward for more selection.
- Tap X to exit the menu.
- Tap ↶ to return to the previous screen.

- 4 Tap “CANCEL”.

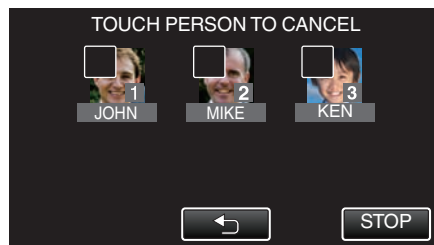

- 5 Tap the person to cancel registration of.



-  appears on the selected person.
- To remove  from a person, tap on the person again.

- 6 Tap “SET”.

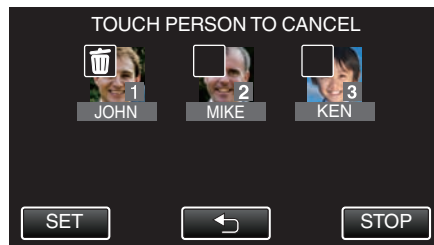

- 7 Tap “YES”.

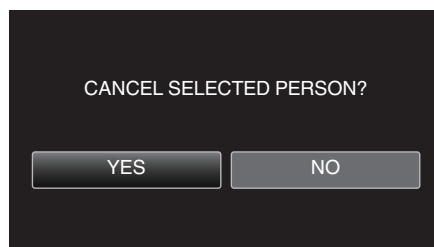

- Tap “YES” to delete the face information of the selected person.
- Tap “NO” to return to the previous screen.
- Tap “OK” when the deletion complete screen appears.

Reducing Camera Shake

When the image stabilizer is set, camera shake during video recording can be effectively reduced.



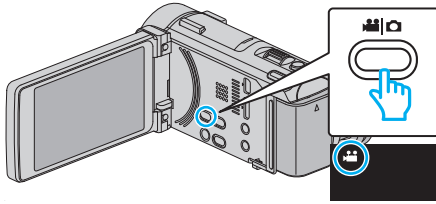

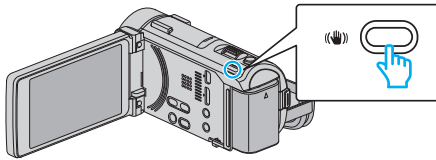

1 Open the LCD monitor.



2 Press the  button to change the setting.



- The setting of image stabilizer changes with every press.

Setting	Details
 OFF	Deactivates image stabilizer.
 ON	Reduces camera shake under normal shooting conditions.
 ON (AIS) ( video mode only)	Reduces camera shake more effectively when shooting bright scenes on the wide angle end. Only on the wide angle end (approx. 5x).
 ON (Enhanced AIS) ( video mode only)	The area of correction in the enhanced AIS mode is greater than that in the AIS mode. Camera shake can be reduced more effectively even when recording is performed by zooming from wide angle to telephoto, or moving together with the subject.

Memo :

- It is recommended to set the image stabilizer to "OFF" when shooting a subject of little movement with the unit on a tripod.
- Complete stabilization may not be possible if camera shake is excessive.
- When "ON (AIS)" is set, the angle of view becomes narrower. In the enhanced AIS mode, the angle of view becomes even narrower than "ON (AIS)".
- Dynamic zoom is not available in the enhanced AIS mode.
- Image stabilization only starts when the SNAPSHOT button is pressed halfway during still image recording.

Slow-motion (High-speed) Recording





You can record videos in slow-motion by increasing the recording speed to emphasize the movements, and play back the slow-motion video smoothly. This is a handy function for checking movements, such as golf swings.

Recording Speed	300 fps
Image Size	720×480
Maximum Recording Time	144 m
Maximum Playback Time	12 h
Image Size when Connected to Monitor	1920×1080

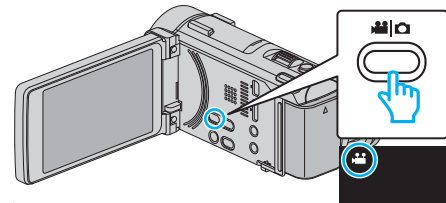
- The playback time will be 5 times of the actual recorded time. (Example: If the recorded time is 1 minute, the playback time will be 5 minutes.)

1 Open the LCD monitor.



- Check if the recording mode is .
- If the mode is  still image, tap  on the recording screen to display the mode switching screen. Tap  to switch the mode to video. (You can also use the  button on this unit.)

2 Tap "MENU".

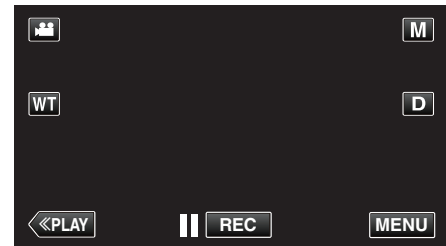

- The shortcut menu appears.

3 Tap "MENU" in the shortcut menu.

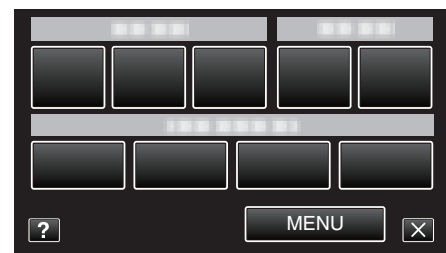

4 Tap "HIGH SPEED RECORDING".

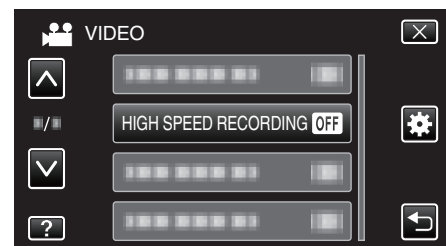

5 Tap "ON".



- When “ON” is tapped, 300 frames can be recorded in 1 second.
- To cancel high-speed recording, tap “OFF”.

6 Start recording.

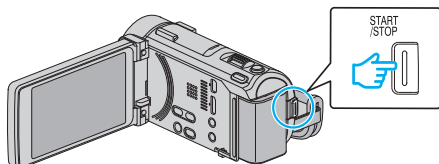

- Press the START/STOP button again to stop recording.
- Settings of high-speed recording are not saved when the power is turned off.

Memo :

- Images may appear grainier than other videos. The image displayed on the LCD monitor during recording may also appear grainier.
- Audio sound is not recorded together with the video.
- When high-speed recording is enabled, only the optical zoom can be used.
- During high-speed recording, “TOUCH PRIORITY AE/AF” is set to “OFF”. In addition, as image stabilizer is set to “OFF”, it is recommended that a tripod be used, and recording be performed in a bright location with the subject magnified as much as possible.

“Tripod Mounting” (p. 71)

Recording at Intervals (TIME-LAPSE RECORDING)

Enables the changes of a scene that occur slowly over a long period to be shown within a short time by taking frames of it at a certain interval. This is useful for making observations such as the opening of a flower bud.

1 Open the LCD monitor.

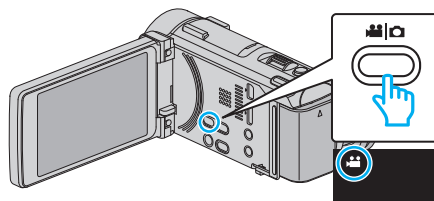

- Check if the recording mode is .
- If the mode is still image, tap on the recording screen to display the mode switching screen. Tap to switch the mode to video. (You can also use the button on this unit.)

2 Tap “MENU”.

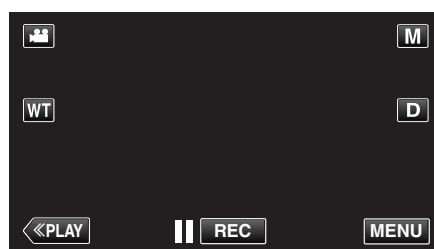

- The shortcut menu appears.

3 Tap “MENU” in the shortcut menu.

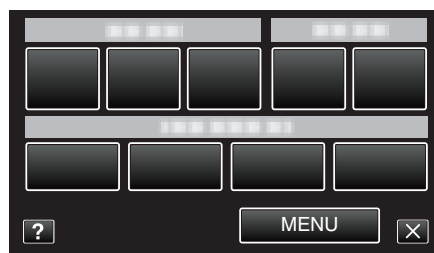

4 Tap “TIME-LAPSE RECORDING”.

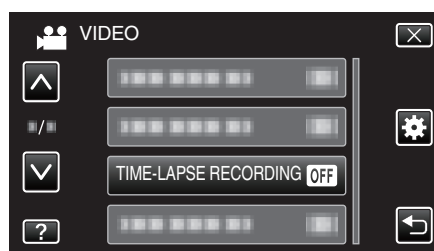

- Tap or to move upward or downward for more selection.
- Tap to exit the menu.
- Tap to return to the previous screen.

5 Tap to select a recording interval (1 to 80 seconds).

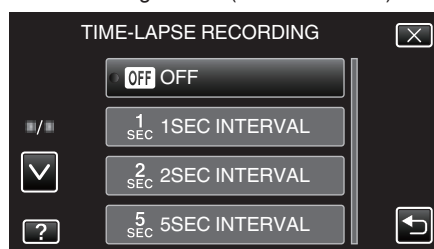

- The greater the number of seconds, the longer the recording interval.
- Tap or to move upward or downward for more selection.
- Tap to exit the menu.
- Tap to return to the previous screen.

6 Start recording.

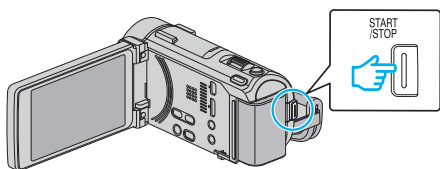

- A frame is taken at intervals of the selected period.
- When the recording interval is set to "20SEC INTERVAL" or higher, this unit switches to the power-saving mode between recordings. At the next point to record, the power-saving mode will be turned off and recording will start automatically.
- Press the START/STOP button again to stop recording.

Indications During Time-Lapse Recording

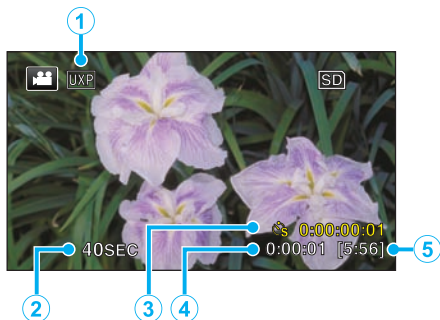

	Display	Description
①	Video Quality	Displays the icon of the video quality that is set.
②	Speed Indicator	Displays the recording interval that is set.
③	Recorded Time	Displays the actual recorded time of the video. Recorded time increases in units of frames.
④	Actual Elapsed Time	Displays the actual elapsed time after recording starts.
⑤	Remaining Recording Time	Remaining time left to record with the currently selected video quality.

Time-Lapse Setting

The greater the number of seconds, the longer the recording interval.

Setting	Details
OFF	Deactivates the function.
1SEC INTERVAL	Takes a frame at 1-second intervals. Recorded videos will be played back at 30 times speed.
2SEC INTERVAL	Takes a frame at 2-second intervals. Recorded videos will be played back at 60 times speed.
5SEC INTERVAL	Takes a frame at 5-second intervals. Recorded videos will be played back at 150 times speed.
10SEC INTERVAL	Takes a frame at 10-second intervals. Recorded videos will be played back at 300 times speed.
20SEC INTERVAL	Takes a frame at 20-second intervals. Recorded videos will be played back at 600 times speed.
40SEC INTERVAL	Takes a frame at 40-second intervals. Recorded videos will be played back at 1 200 times speed.
80SEC INTERVAL	Takes a frame at 80-second intervals. Recorded videos will be played back at 2 400 times speed.

Caution :

- Audio cannot be recorded during time-lapse recording.
- Zooming, simultaneous still image recording, and image stabilizer are not available in time-lapse recording.
- When recording is stopped with the recorded time less than "0:00:00:17", the video will not be saved.

Memo :

- Settings of time-lapse recording are reset when the power is turned off. To start time-lapse recording again, it is necessary to make the selection once more.
- Recording stops automatically 99 hours after it is started.
- Make use of a tripod and AC adapter for time-lapse recordings with long intervals.

It is also recommended to fix the focus and white balance manually.

"Tripod Mounting" (☞ p. 71)

"Adjusting Focus Manually" (☞ p. 86)

"Setting White Balance" (☞ p. 90)

Recording Automatically by Sensing Movements (AUTO REC)

This function enables the unit to record automatically by sensing the changes in subject's movement (brightness) within the red frame displayed on the LCD monitor.

It can be set for both video and still image modes.

- 1 Open the LCD monitor.

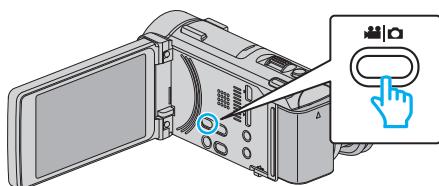

- Set the recording mode to either video or still image.
 - To switch the mode between video and still image, tap or on the recording screen to display the mode switching screen. Tap or to switch the mode to video or still image respectively. (You can also use the / button on this unit.)
- 2 Compose the picture according to the subject.
 - Adjust the angle of view with the zoom, etc.
 - 3 Tap "MENU".

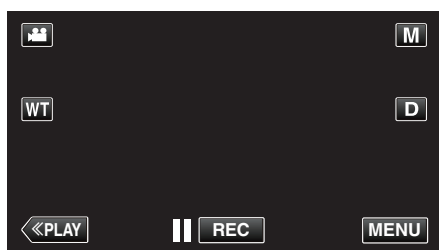

- The shortcut menu appears.
- 4 Tap "MENU" in the shortcut menu.

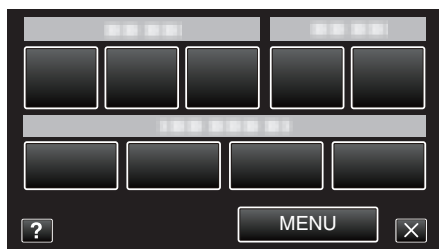

- 5 Tap "AUTO REC".

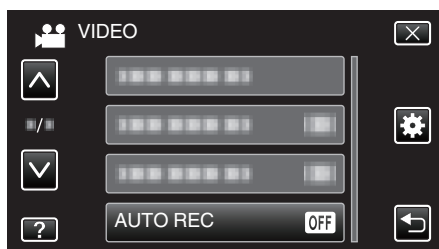

- Tap or to move upward or downward for more selection.
 - Tap to exit the menu.
 - Tap to return to the previous screen.
- 6 Tap "ON".

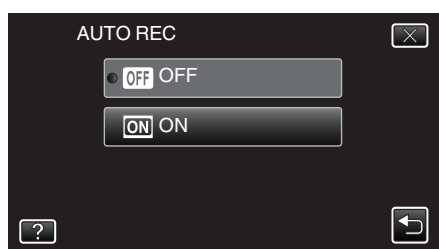

- 7 Recording starts automatically when the subject within the red frame moves.

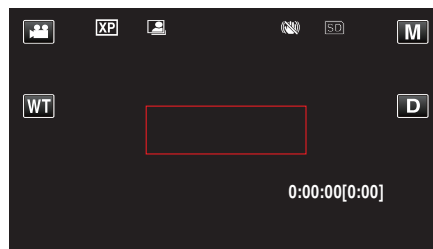

- A red frame appears 2 seconds after the menu display disappears.
- For video recording, recording continues while there are still movements of the subject (changes in brightness) within the red frame. When there are no more movements of the subject (changes in brightness) within the red frame, recording will stop in 5 seconds.
- To stop video recording manually, press the START/STOP button. However, as the "AUTO REC" setting remains at "ON" even after the video recording is stopped, recording starts again when movements of the subject (changes in brightness) are detected within the red frame. To cancel "AUTO REC", set it to "OFF".

Caution :

- Digital zoom, image stabilizer, self-timer, and continuous shooting are not available after "AUTO REC" is set.
- "AUTO REC" cannot be used together with "TIME-LAPSE RECORDING". When both are set, priority is given to "TIME-LAPSE RECORDING".
- "IMAGE SIZE" cannot be changed after "AUTO REC" is selected. Set it before selecting "AUTO REC".
- The auto power off and power-saving modes are not available after "AUTO REC" is set.

Memo :

- Recording stops when there are no changes for 5 seconds during video recording.
- Settings of "AUTO REC" are not saved when the power is turned off.
- Recording may not start when the movements of the subject within the red frame are too fast or the changes in brightness are too small.
- Recording may start due to changes in brightness even if there is no movement within the red frame.
- While zooming, recording cannot be started.

Taking Group Shots (Self-timer)

The 10-second self-timer and Face Detection self-timer are convenient functions for taking group photos. The 2-second self-timer is useful for preventing camera shake caused by pressing the shutter button.

Memo :

When shooting a photo using the self-timer function, use of a tripod is recommended. "Tripod Mounting" (p. 71)

Using the 2-/10-second Self-timer

1 Open the LCD monitor.

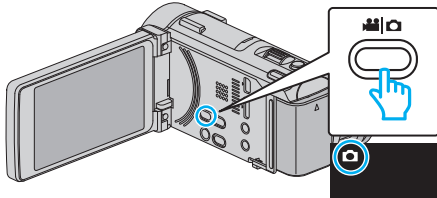

- Check if the recording mode is .
- If the mode is video, tap on the recording screen to display the mode switching screen. Tap to switch the mode to still image. (You can also use the button on this unit.)

2 Tap "MENU".

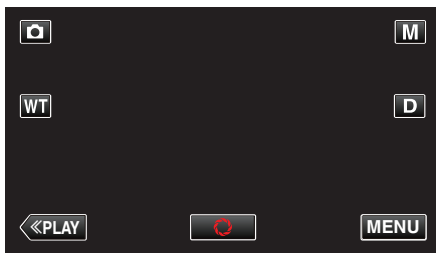

- The shortcut menu appears.

3 Tap "MENU" in the shortcut menu.



4 Tap "SELF-TIMER".

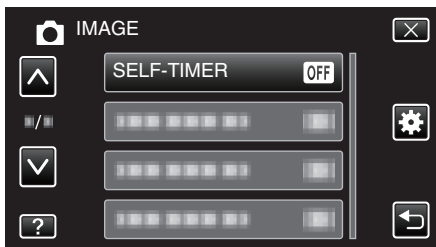

- Tap or to move upward or downward for more selection.
- Tap to exit the menu.
- Tap to return to the previous screen.

5 Tap "2SEC" or "10SEC".

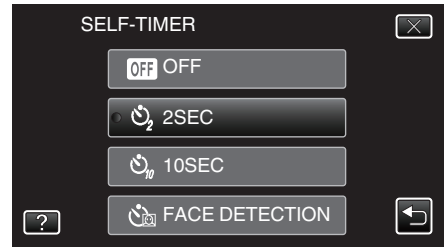

6 Set the focus on the subject.

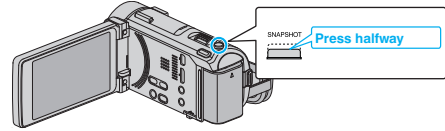

- When focused, the focus icon lights up in green.

7 Take a still image.

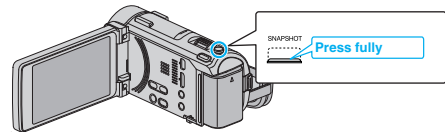

- A timer appears and countdown to shooting starts.
- To stop the self-timer, press the SNAPSHOT button again.

Using the Face Detection Self-timer

Pressing the SNAPSHOT button starts face detection, and shooting is performed three seconds after another person enters the frame. This function is useful when you want to include the photographer in the group photo.

- 1 Open the LCD monitor and select the still image mode.

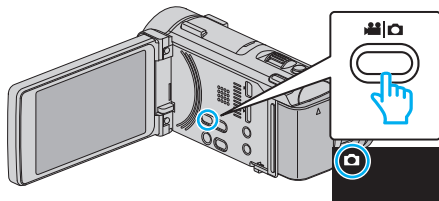

- The still image mode icon appears.

- 2 Tap "MENU".

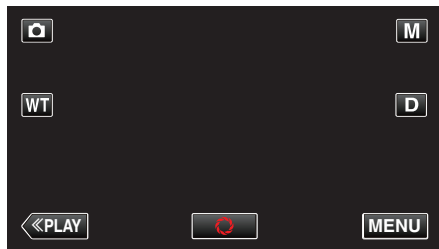

- The shortcut menu appears.

- 3 Tap "MENU" in the shortcut menu.

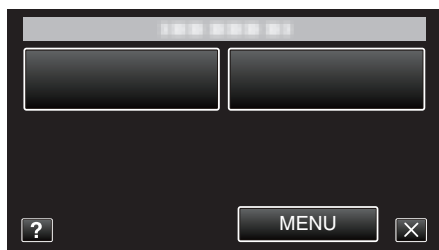

- 4 Tap "SELF-TIMER".

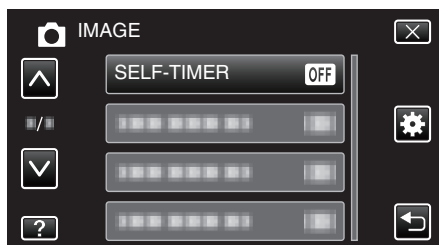

- Tap \wedge or \vee to move upward or downward for more selection.
- Tap \times to exit the menu.
- Tap \curvearrowright to return to the previous screen.

- 5 Tap "FACE DETECTION".

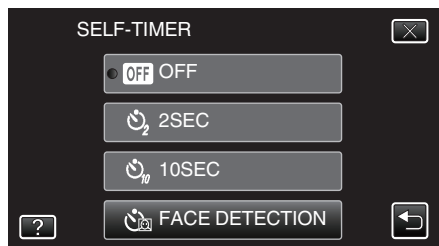

- 6 After making sure that everyone is facing the camera, press the SNAPSHOT button.

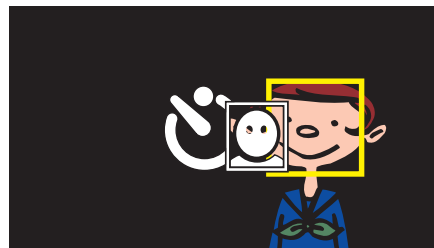
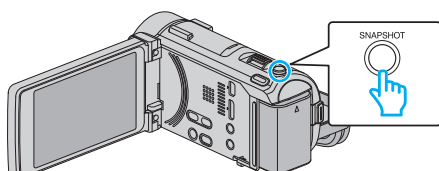

- Frames appear around the faces of the subjects.
- Pressing the SNAPSHOT button again starts the 10-second self-timer.

- 7 The photographer enters the frame.

Photographer

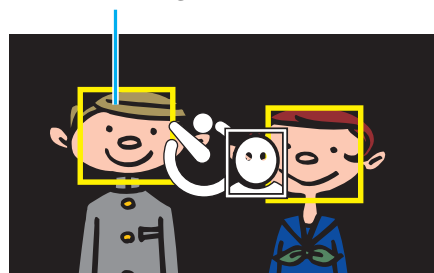

- The shutter is released 3 seconds after the photographer enters the frame.
- To stop the self-timer, press the SNAPSHOT button again.

Memo :

- The "FACE DETECTION" function may fail to detect faces depending on the shooting environment.

Recording Videos with Date and Time

You can record videos together with the date and time. Set this when you want to save the file with date and time display. (The date and time cannot be deleted after recording.)

1 Open the LCD monitor.

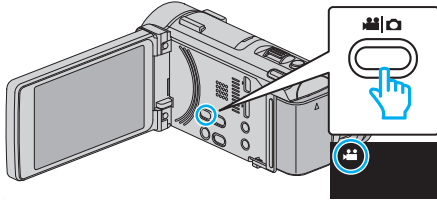

- Check if the recording mode is .
- If the mode is still image, tap on the recording screen to display the mode switching screen. Tap to switch the mode to video. (You can also use the button on this unit.)

2 Tap "MENU".

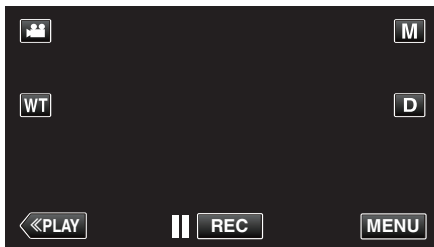

- The shortcut menu appears.

3 Tap "MENU" in the shortcut menu.

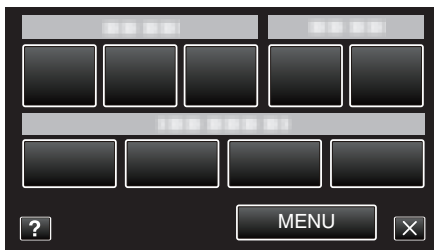

4 Tap "DATE/TIME RECORDING".

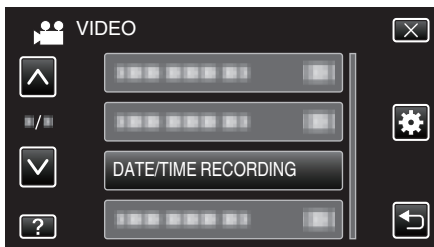

- Tap or to move upward or downward for more selection.
- Tap to exit the menu.
- Tap to return to the previous screen.
- When the item is tapped, the precaution for date/time recording appears.

5 Press the START/STOP button to start recording.

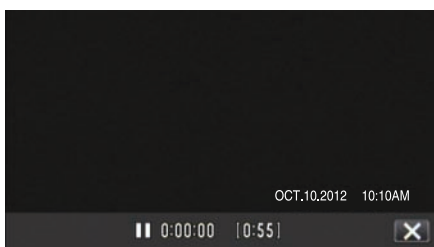

- Press the START/STOP button again to stop recording.
- Tap to exit "DATE/TIME RECORDING".

(To perform operations other than recording, tap to cancel the "DATE/TIME RECORDING" first.)

Caution :

- The date and time cannot be deleted after recording.

Checking the Remaining Recording Time

You can check the remaining recording time on the SD card as well as the remaining battery power.

- 1 Open the LCD monitor.

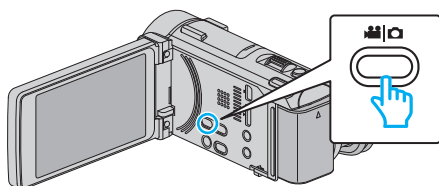

- Set the recording mode to either video or still image.
- To switch the mode between video and still image, tap or on the recording screen to display the mode switching screen. Tap or to switch the mode to video or still image respectively. (You can also use the / button on this unit.)

- 2 Tap "MENU".

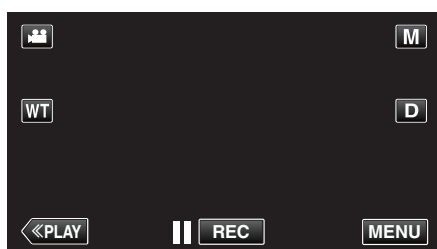

- The shortcut menu appears.

- 3 Tap "MENU" in the shortcut menu.

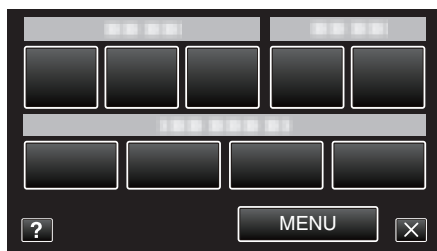

- 4 Tap "INFO.".

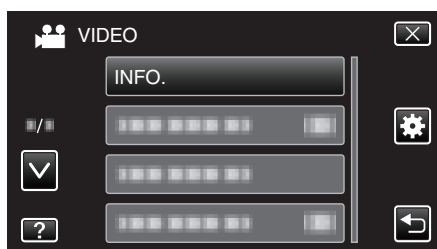

- Tap or to move upward or downward for more selection.
- Tap to exit the menu.
- Tap to return to the previous screen.
- If in the still image mode, go directly to step 6.

- 5 Display the remaining recording time.



- The remaining recording time is displayed only in the video recording mode.
- To display the remaining battery power, tap .
- will not be displayed when the AC adapter is connected.
- Tap to return to the recording mode.

- To exit the display, tap .

- 6 Display the remaining battery power.

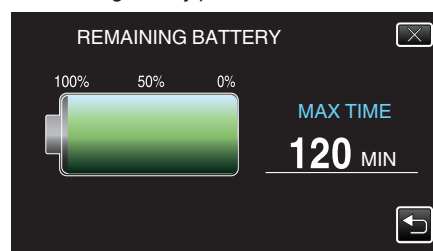

- For video recording, tap to return to the remaining recording time display. For still image recording, tap to return to the recording mode.
- To exit the display, tap .
- Remaining battery power will not be displayed when the AC adapter is connected.

Memo :

- You can change to the desired video quality by tapping on it from the remaining recording time display.

Recording

Approximate Video Recording Time

Quality	SDHC/SDXC Card					
	4 GB	8 GB	16 GB	32 GB	48 GB	64 GB
60p	15 m	35 m	1 h 10 m	2 h 30 m	3 h 50 m	5 h
UXP	20 m	40 m	1 h 20 m	2 h 50 m	4 h 10 m	5 h 40 m
XP	30 m	1 h	2 h	4 h	6 h	8 h 10 m
SP	40 m	1 h 20 m	2 h 50 m	5 h 50 m	8 h 30 m	11 h 30 m
EP	1 h 40 m	3 h 30 m	7 h 10 m	14 h 40 m	21 h 30 m	28 h 50 m

- The actual recording time may shorten depending on the shooting environment.
- “UXP”, “XP”, “SP”, and “EP” can only be selected in the 60i mode (when “SYSTEM SELECT” is set to “60i”).

Approximate Number of Still Images (Unit: Number of Shots)

Image Size	SDHC Card			
	4 GB	8 GB	16 GB	32 GB
3968×2976 (11.8M) (4:3)	500	1100	2200	4600
2656×1992 (5.3M) (4:3)	1200	2500	5000	9999
1920×1440 (2.8M) (4:3)	2400	4900	9700	9999
640×480 (0.3M) (4:3)	9999	9999	9999	9999
1920×1080 (2M) (16:9)	3100	6500	9999	9999

- Still images that are captured during video recording or video playback are saved at a size of 1920 x 1080.

Approximate Recording Time (Using Battery)

Battery Pack	Actual Recording Time		Continuous Recording Time	
	60i	60p	60i	60p
BN-VG114U (Supplied)	40 m	35 m	1 h 15 m	1 h
BN-VG121U	1 h 5 m	50 m	1 h 55 m	1 h 30 m
BN-VG138U	1 h 55 m	1 h 30 m	3 h 25 m	2 h 45 m

- The above are values when “LIGHT” is set to “OFF” and “MONITOR BRIGHTNESS” is set to “3” (standard).
- The actual recording time may be shorter if zooming is used or if recording is stopped repeatedly. (It is recommended to prepare battery packs ready for three times the expected recording time.)
- Recording time may differ depending on the shooting environment and usage.
- When the battery life is reached, the recording time becomes shorter even if the battery pack is fully charged. (Replace the battery pack with a new one.)

Playing Back Videos

You can select and play back the recorded videos from an index screen (thumbnail display).

1 Open the LCD monitor.

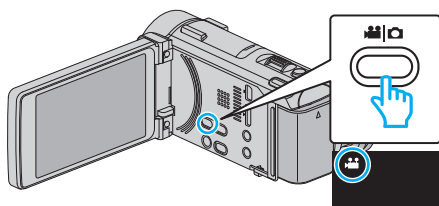

- Check if the recording mode is .
- If the mode is still image, tap on the recording screen to display the mode switching screen. Tap to switch the mode to video. (You can also use the / button on this unit.)

2 Tap “<<PLAY” to select the playback mode.

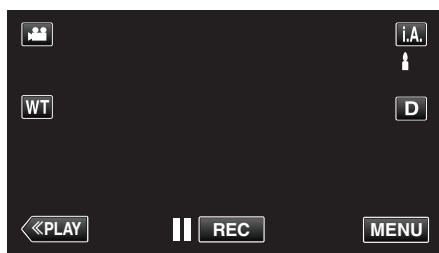

3 Tap on the file to start playback.

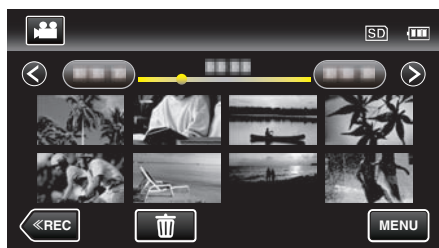

- Tap to pause.
- Tap to return to the index screen.
- appears on the last image played back.
- Images recorded in 60p mode and 60i mode are displayed on the index screen separately.
- To view the images recorded in 60p mode, set “SYSTEM SELECT” in the video recording menu to “60p” before selecting the playback mode. In cases such as during Digest Playback or when playing back/editing a playlist, set “SYSTEM SELECT” in the same way before operating.
- To view the images recorded in 60i mode, set “SYSTEM SELECT” in the video recording menu to “60i” before selecting the playback mode. In cases such as during Digest Playback or when playing back/editing a playlist, set “SYSTEM SELECT” in the same way before operating.

Operation Buttons for Video Playback

During Index Screen Display

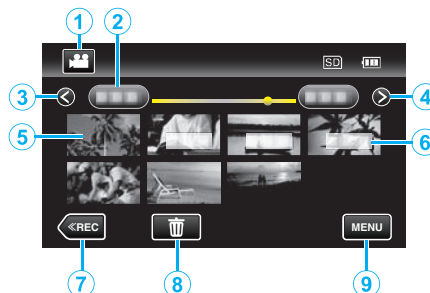

	Display	Description
①	Video/Still Image Mode	Switches between video and still image modes.
②	Date	Moves to the previous/next date
③	<	Displays the previous index screen (thumbnail display) • You can perform the same operation with the zoom lever.
④	>	Displays the next index screen (thumbnail display) • You can perform the same operation with the zoom lever.
⑤	Thumbnail (File)	Tap on thumbnail - Starts playback Drag to right - Scrolls to the right to show the previous index screen (thumbnail display) Drag to left - Scrolls to the left to show the next index screen (thumbnail display)
⑥	Recording Date	Recording date (only displayed on the first file of each date)
⑦	<<REC	Switches to the recording mode.
⑧		Displays the index screen (thumbnail display) to perform deletion
⑨	MENU	Displays the menu screen

During Video Playback

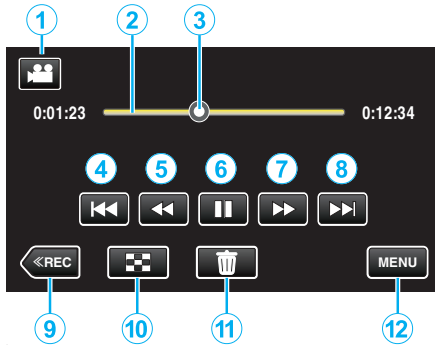

	Display	Description
①	Video/Still Image Mode	Switches between video and still image modes.
②	Timeline Bar	Tap on a random position - Moves to the tapped position Drag playback point to the left or right - Starts playback from the new position Tap on a random position - Moves to the tapped position
③	Pointer	Displays the current estimated playback position within the scene
④	⏮	Returns to the beginning of the scene Returns to the previous scene if tapped at the beginning of a scene. • You can perform the same operation with the zoom lever.
⑤	⏪	Reverse search (speed increases with each tap)
⑤	⏩	Reverse slow-motion / Press and hold to start reverse slow playback
⑥	▶ / ⏸	Playback/pause
⑦	⏭	Forward search (speed increases with each tap)
⑦	⏩	Forward slow-motion / Press and hold to start slow playback
⑧	⏭	Advances to the next scene • You can perform the same operation with the zoom lever.
⑨	<<REC	Switches to the recording mode.
⑩	⏹	Stop (returns to index screen)
⑪	🗑	Deletes the currently displayed video.
⑫	MENU	Displays the menu screen

Memo :

- Tap or drag on the operation area of the touch screen.
 - Operations buttons on the touch screen disappear if the unit is not operated for about 5 seconds. Tap on the screen to display the operation buttons again.
 - You can search for a specific file by the recording date.
- “Searching for a Specific Video/Still Image by Date” (p. 125)
- The recording date and time can be displayed on the screen during playback.
- “DISPLAY DATE/TIME” (p. 192)

Adjusting the Volume of Videos

You can use the zoom/volume lever to control the volume.

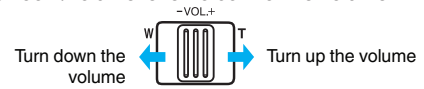

Caution :

- Make a backup of important recorded data. It is recommended to copy your important recorded data to a DVD or other recording media for storage.
- This unit is a microcomputer-controlled device. Electrostatic discharge, external noise and interference (from a TV, a radio, etc.) might prevent it from functioning properly. In such a case, turn off the power, then remove the AC adapter and battery pack. This unit will be reset.

Checking the Recording Date and Other Information

You can see the recording information of the recorded videos.

1 Open the LCD monitor.

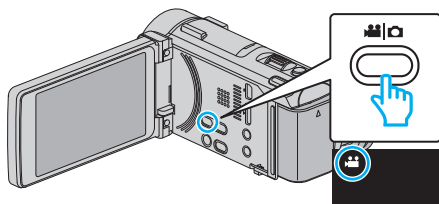

- Tap or to select the video or still image mode.

2 Tap “<<PLAY” to select the playback mode.

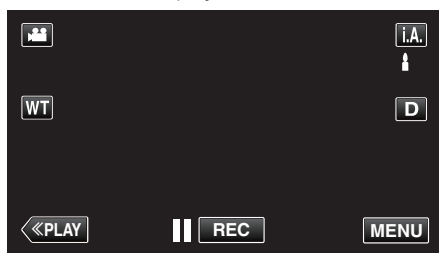

3 Tap on the file to start playback.

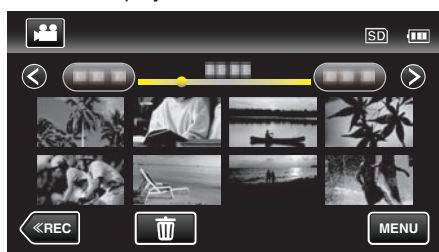

4 Tap “MENU”.

5 Tap “FILE INFORMATION”.

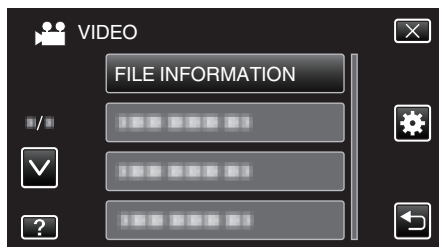

- Tap or to move upward or downward for more selection.
- Tap to exit the menu.
- Tap to return to the previous screen.

You can display the recording date and duration of the selected file.

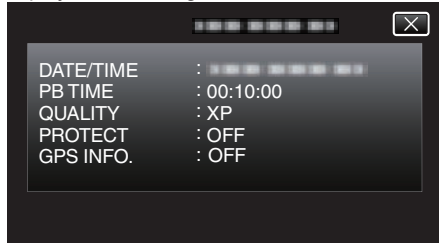

Checking the Content of Videos Quickly (Digest Playback)

You can play back a digest of the recorded videos (Digest Playback). This is useful for checking the content of the videos quickly.

1 Open the LCD monitor.

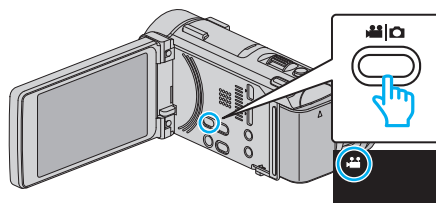

- Check if the recording mode is .
- If the mode is still image, tap on the recording screen to display the mode switching screen. Tap to switch the mode to video. (You can also use the / button on this unit.)

2 Tap “<<PLAY” to select the playback mode.

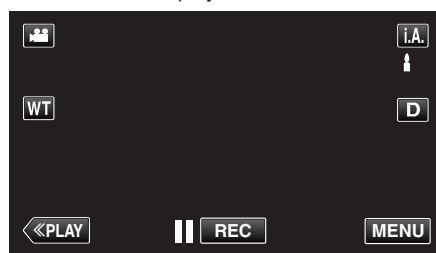

3 Tap “MENU”.

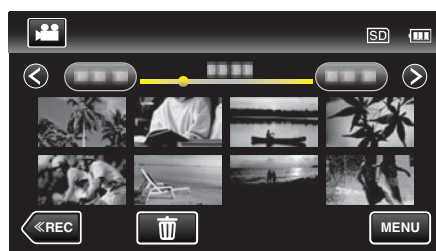

4 Tap “DIGEST PLAYBACK”.

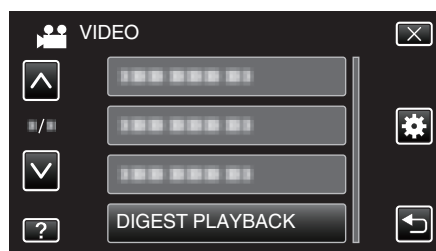

5 Tap to select a date for Digest Playback.

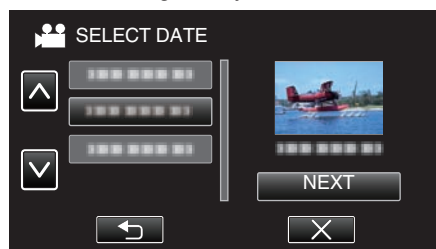

- After selecting a date, tap “NEXT”.
- When “ALL” is tapped, Digest Playback will be performed for all the dates.
- Tap or to move upward or downward for more selection.
- Tap to exit the menu.
- Tap to return to the previous screen.

6 Select the Digest Playback time

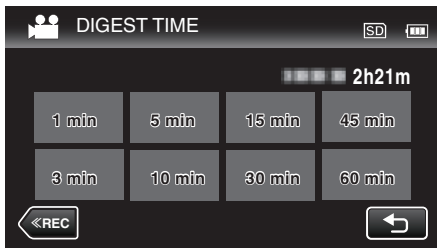

- The time display of Digest Playback varies according to the recording time.
- When it takes time (more than 2 seconds) for “DIGEST PLAYBACK” to start after selecting Digest Playback time, a progress status will be displayed.
- The Digest Playback time is only a guide.

7 Digest Playback starts.

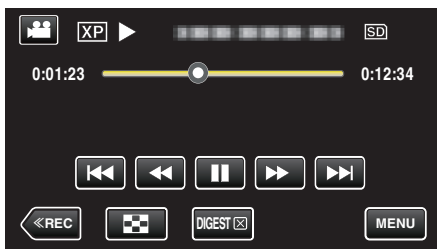

- Tap **||** to pause.
- Tap **⌂** to return to the index screen.
- Tap “DIGEST [X]” to return to the normal playback screen.
- You can tap “MENU” during playback to save the Digest Playback as a playlist.
Tap “SAVE TO PLAYLIST”, then tap “OK”.
- Operations During Video Playback
“Operation Buttons for Video Playback” (p. 119)

Playing a Video with Defective Management Information

The management information of a video may be damaged if recording is not performed correctly, such as turning off the power in the middle of recording. You can perform the following operations to play back the videos with defective management information.

1 Open the LCD monitor.

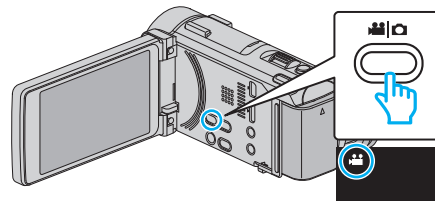

- Check if the recording mode is **📹**.
- If the mode is **📷** still image, tap **📷** on the recording screen to display the mode switching screen.
Tap **📹** to switch the mode to video. (You can also use the **📹/📷** button on this unit.)

2 Tap “<<PLAY” to select the playback mode.

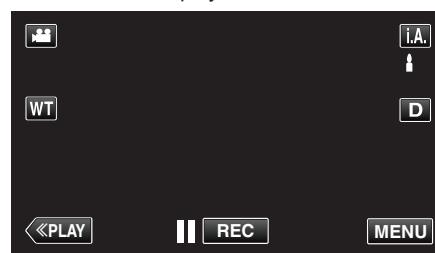

3 Tap “MENU”.

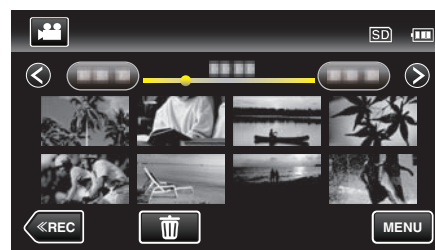

4 Tap “PLAYBACK OTHER FILE”.

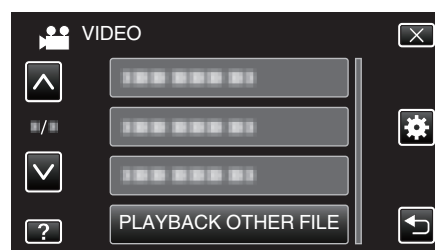

5 Tap on the file to start playback.

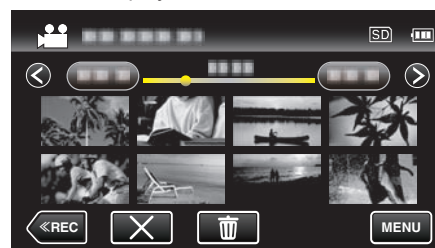

“Playing Back Videos” (p. 119)

Memo :

- An MTS file is created in the EXTMOV folder when management information is corrupted.
- Depending on the condition of the damaged file, playback might fail or may not run smoothly.

Playing Back Still Images

You can select and play back the recorded still images from an index screen (thumbnail display).

1 Open the LCD monitor.

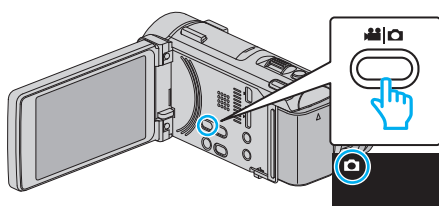

- Check if the recording mode is .
- If the mode is video, tap on the recording screen to display the mode switching screen. Tap to switch the mode to still image. (You can also use the button on this unit.)

2 Tap “<<PLAY” to select the playback mode.

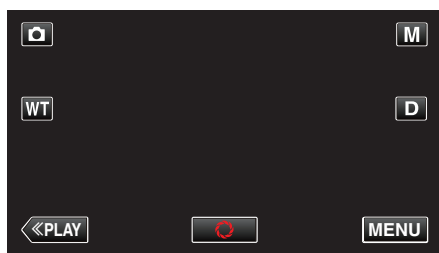

3 Tap on the file to start playback.

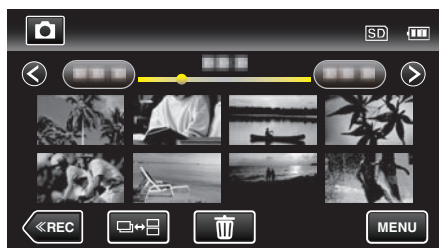

- Tap to return to the index screen.
- Still images that are recorded continuously within 2 seconds or with the continuous shooting mode will be grouped together. Only the first recorded file is shown and the group is displayed with a green frame.

Operation Buttons for Still Image Playback

During Index Screen Display

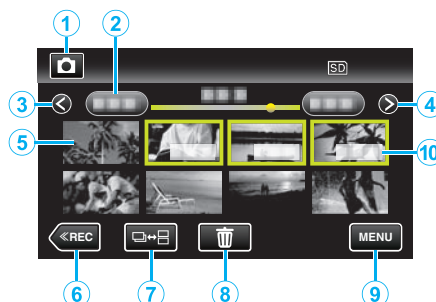

- Still images that are recorded continuously within 2 seconds or with the continuous shooting mode will be grouped together. Only the first recorded file is shown and the group is displayed with a green frame.

	Display	Description
①	Video/Still Image Mode	Switches between video and still image modes.
②	Date	Moves to the previous/next date
③	<	Displays the previous index screen (thumbnail display) • You can perform the same operation with the zoom lever.
④	>	Displays the next index screen (thumbnail display) • You can perform the same operation with the zoom lever.
⑤	File (Still Image)	Tap on thumbnail - Starts playback Drag to right - Scrolls to the right to show the previous index screen (thumbnail display) Drag to left - Scrolls to the left to show the next index screen (thumbnail display)
⑥	<<REC	Switches to the recording mode.
⑦		Still images that are recorded continuously within 2 seconds or with the continuous shooting mode will be grouped together and displayed with a green frame on a separate index screen. The index screen changes between the normal index screen and group index screen with every tap of the button.
⑧		Displays the index screen (thumbnail display) to perform deletion
⑨	MENU	Displays the menu screen
⑩	Recording Date	Recording date (only displayed on the first file of each date)

During Still Image Playback

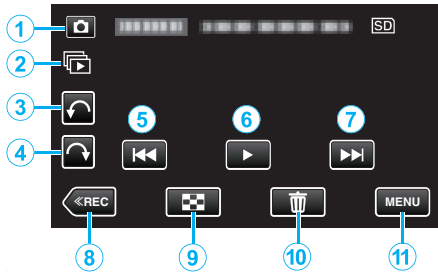

	Display	Description
①	Video/Still Image Mode	Switches between video and still image modes.
②		Continuous playback of still images that are recorded continuously within 2 seconds or with the continuous shooting mode.
③		Rotates to the left (rotates by -90° with each tap)
④		Rotates to the right (rotates by 90° with each tap)
⑤		Returns to the previous still image <ul style="list-style-type: none"> You can perform the same operation with the zoom lever.
⑥		Starts/pauses slideshow “Slideshow Playback” (p. 124)
⑦		Advances to the next still image <ul style="list-style-type: none"> You can perform the same operation with the zoom lever.
⑧	<<REC	Switches to the recording mode.
⑨		Returns to index screen
⑩		Deletes the currently displayed still image.
⑪	MENU	Displays the menu screen

Memo :

- Tap or drag on the operation area of the touch screen.
- Operations buttons on the touch screen disappear if the unit is not operated for about 5 seconds. Tap on the screen to display the operation buttons again.
- You can rotate a still image 90° to the right or left during playback. Rotation applies to the on-screen display only.
- You can search for a specific file by the recording date. This is useful when searching from a large number of files.
“Searching for a Specific Video/Still Image by Date” (p. 125)

Caution :

- This unit is a microcomputer-controlled device. Electrostatic discharge, external noise and interference (from a TV, a radio, etc.) might prevent it from functioning properly. In such a case, turn off the power, then remove the AC adapter and battery pack. This unit will be reset.

Slideshow Playback

Still images can be played back in a slideshow.
Tap during still image playback to start the slideshow.

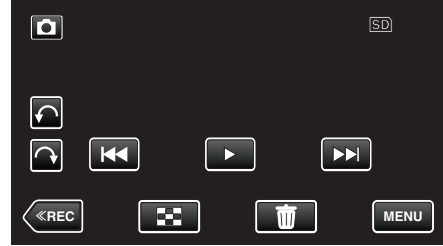

“Operation Buttons for Still Image Playback” (p. 123)

Memo :

- Effects can be added to the transitions in slideshow playback.
“SLIDE SHOW EFFECTS ” (p. 195)

Searching for a Specific Video/Still Image by Date

When there is a large number of recorded videos and still images, it is difficult to look for the desired file from the index screen.

Use the search function to find the file you want.

You can search and play videos or still images according to recording dates.

1 Tap "MENU".

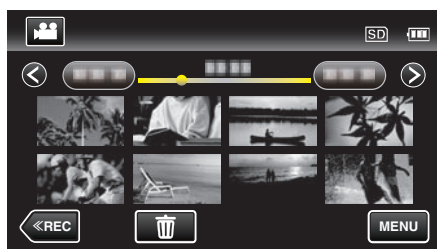

- Searching can be performed in both the video and still image modes.
*The image shows the video mode.

2 Tap "SEARCH DATE".

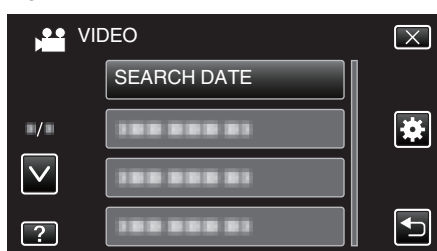

3 Tap a recording date, then tap "NEXT".

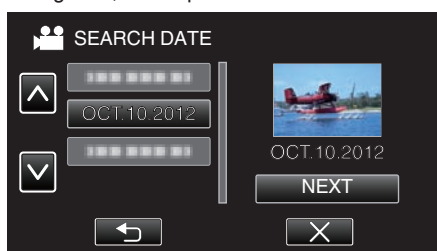

- Tap again to cancel the selected date.

4 Tap on the file to start playback.

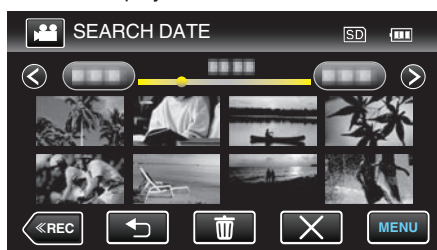

- You can select videos in the video mode and still images in the still image mode.
- Only the files recorded on the selected date are displayed.
- Tap X to stop searching and return to the index screen (thumbnail display).

Deleting Files of a Selected Date :

Tap  on the index screen (thumbnail display) to delete unwanted files.
"Deleting Unwanted Files" (p. 129)

Connecting to and Viewing on TV

You can connect this unit to a TV for playback. The image quality on TV varies with the type of TV and the connecting cable. Select the connector that best suits your TV.

- Refer also to the instruction manual of the TV in use.

"Connecting via the HDMI Mini Connector" (p. 126)

"Connecting via the AV Connector" (p. 127)

- To display the date and time on TV, set both "DISPLAY DATE/TIME" and "DISPLAY ON TV" to "ON".

"DISPLAY DATE/TIME" (p. 192)

"DISPLAY ON TV" (p. 203)

Unnatural Displays on TV

Trouble	Action
Images do not appear on the TV properly.	<ul style="list-style-type: none"> • Disconnect the cable and connect again. • Turn off and on this unit again. • Images may not appear properly when the remaining battery power is low. Use an AC adapter.
Images are projected vertically on the TV.	<ul style="list-style-type: none"> • Set "VIDEO OUTPUT" in the "COMMON" menu to "4:3". <p>"VIDEO OUTPUT" (p. 203)</p>
Images are projected horizontally on the TV.	<ul style="list-style-type: none"> • Adjust the TV's screen accordingly.
The color of images looks strange.	<ul style="list-style-type: none"> • Adjust the TV's screen accordingly.
HDMI-CEC functions do not work properly, and the TV does not work in conjunction with this unit.	<ul style="list-style-type: none"> • TVs may operate differently depending on the specifications, even if they are HDMI-CEC compliant. Therefore, the HDMI-CEC functions of this unit cannot be guaranteed to operate in combination with all the TVs. In such cases, set "HDMI CONTROL" to "OFF". <p>"HDMI CONTROL" (p. 204)</p>
The language on the display changed.	<ul style="list-style-type: none"> • It may occur when you connect this unit to a TV with different language setting using an HDMI mini cable.

Caution :

- Do not remove the recording medium or perform any other operation (such as turning off the power) while accessing files. Also, be sure to use the provided AC adapter, as the data on the recording medium may be corrupted if the battery becomes exhausted during operation. If the data on the recording medium becomes corrupted, format the recording medium to use the medium again.

Connecting via the HDMI Mini Connector

If you are using an HDTV, you can play back in HD quality by connecting to the HDMI mini connector.

- Use a High Speed HDMI mini cable as the HDMI mini cable when not using the provided one.
- Refer also to the instruction manual of the TV in use.

1 Connect to a TV.

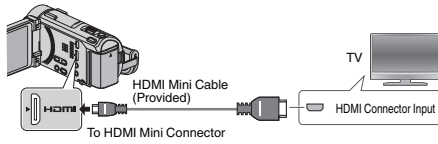

- Turn off the camcorder by pressing the  button for about 2 seconds.

2 Connect the AC adapter to this unit.

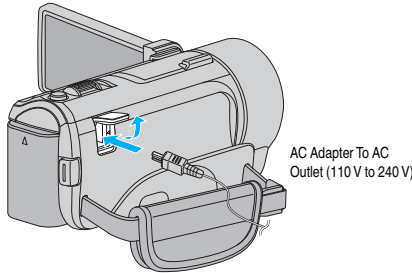

- The unit turns on automatically.

3 Press the external input button on the TV to switch to the input from this unit via the connected connector.

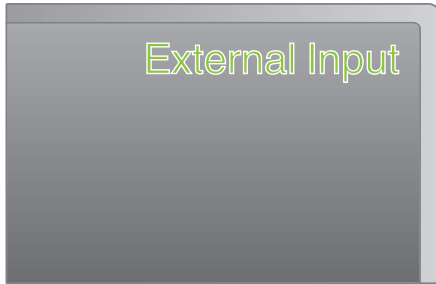

4 Play back a file.

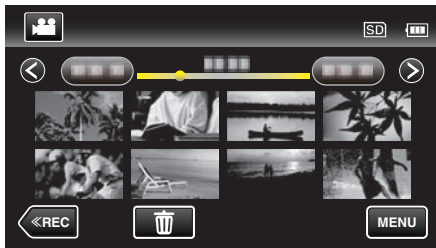

“Playing Back Videos” (p. 119)

“Playing Back Still Images” (p. 123)

Memo :

- Change the settings in “HDMI OUTPUT” according to the connection.
“HDMI OUTPUT” (p. 204)
- When connected to the TV via the HDMI mini cable, images and sounds may not be output properly depending on the TV connected. In such cases, perform the following operations.
 - 1) Disconnect the HDMI mini cable and connect it again.
 - 2) Turn off and on this unit again.
- For questions about the TV or method of connection, contact your TV's manufacturer.

Operating in Conjunction with TV via HDMI

Connecting this unit to an HDMI-CEC enabled TV using the HDMI mini cable allows linked operations with the TV to be performed.

- HDMI-CEC (Consumer Electronics Control) is an industry standard that enables interoperability between HDMI-CEC compliant devices that are connected via HDMI cables.

Memo :

- Not all HDMI control devices comply with the HDMI-CEC standard. The HDMI control function of this unit will not work when connected to these devices.
- This unit is not guaranteed to operate with all HDMI-CEC enabled devices.
- Depending on the specifications of each HDMI-CEC enabled device, some functions may not work with this unit. (For details, refer to the instruction manual of your TV.)
- Unintended operations may occur with some connected devices. In these cases, set “HDMI CONTROL” to “OFF”.
“HDMI CONTROL” (p. 204)

Preparations

- Connect an HDMI mini cable between this unit and the TV.
“Connecting via the HDMI Mini Connector” (p. 126)
- Turn on the TV and set the HDMI-CEC related setting to “ON”. (For details, refer to the instruction manual of the TV.)
- Turn on this unit and set “HDMI CONTROL” in the “COMMON” menu to “ON”.
“HDMI CONTROL” (p. 204)

Operation Method 1

- 1 Turn on this unit.
- 2 Select the playback mode.
- 3 Connect the HDMI mini cable.
 - TV turns on automatically and switches to HDMI input mode when this unit is turned on.

Operation Method 2

- 1 Turn off the TV.
 - This unit turns off automatically.

Memo :

- Depending on the TV connected, the display language of this unit will automatically switch to the language that is selected for the TV when this unit is turned on. (This is applicable only if this unit supports the language selected for the TV.) To use this unit with a language that differs from the display language of the TV, set “HDMI CONTROL” to “OFF”.
- The display language of the TV will not switch automatically, even if the display language of this unit is changed.
- These functions may not work correctly when devices such as amplifier and selector are connected. Set “HDMI CONTROL” to “OFF”.
- If HDMI-CEC does not work properly, turn off and on this unit again.

Connecting via the AV Connector

By connecting the supplied AV cable to the AV connector, videos can be played back on a TV.

- Refer also to the instruction manual of the TV in use.

1 Connect to a TV.

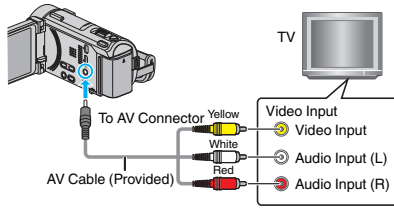

- Turn off the camcorder by pressing the button for about 2 seconds.

2 Connect the AC adapter to this unit.

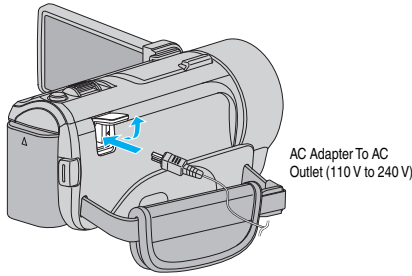

- The unit turns on automatically.

3 Press the external input button on the TV to switch to the input from this unit via the connected connector.

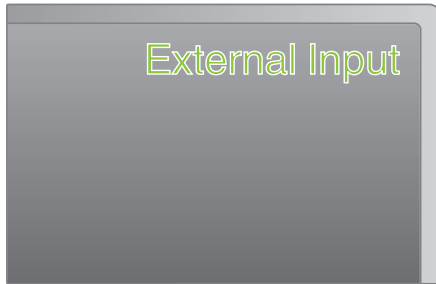

4 Play back a file.

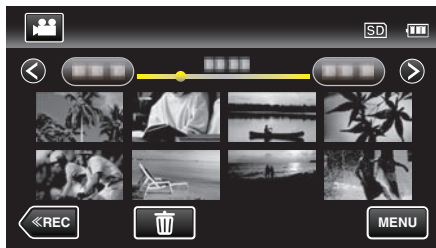

“Playing Back Videos” (p. 119)

“Playing Back Still Images” (p. 123)

Memo :

- For questions about the TV or method of connection, contact your TV's manufacturer.

Playing Back Playlists

Plays back the playlists that you have created.

1 Open the LCD monitor.

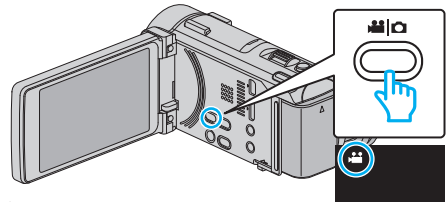

- Check if the recording mode is .
- If the mode is still image, tap on the recording screen to display the mode switching screen. Tap to switch the mode to video. (You can also use the / button on this unit.)

2 Tap “<<PLAY” to select the playback mode.

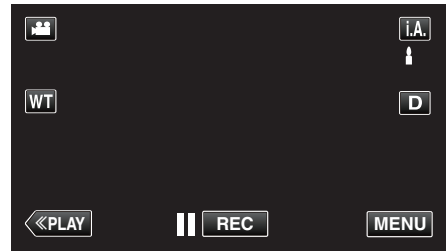

3 Tap “MENU”.

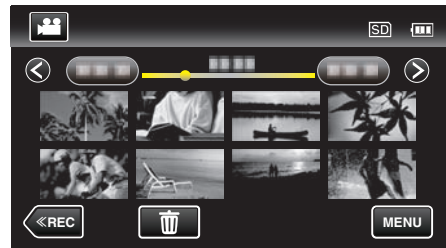

4 Tap “PLAYBACK PLAYLIST”.

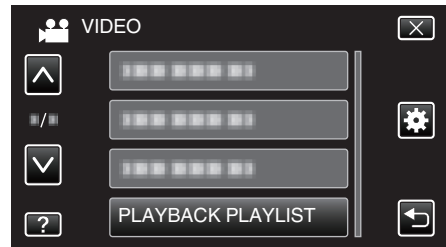

5 Tap to select a playlist.



- Playback of the playlist starts. “Playing Back Videos” (p. 119)
- Tap or to move upward or downward for more selection.
- Tap to return to the index screen.
- Tap “CHECK” and select a playlist to check its content. After checking, tap .
- Playlists with a (Digest Playback) icon are the playlists created during Digest Playback.

Creating Playlists :

“Creating Playlists from the Recorded Videos” (p. 135)

Playing Back a DVD or Blu-ray Disc Created on this Unit

DVDs or Blu-ray discs created using the backup function on this unit can be played back on TV using an optional DVD writer (DVDs only) with playback function (CU-VD50) or a normal DVD or Blu-ray disc player. DVDs can also be played back on this unit by connecting the optional DVD writer with playback function.

“Playing Back with a DVD Writer” (☞ p. 145)

“Playing Back with a BD Writer (External Blu-ray Drive)” (☞ p. 153)

- For details on how to play back on a normal DVD or Blu-ray disc player, refer to the instruction manual of the player.

Playback Device	DVD (AVCHD format)	Blu-ray Disc
DVD writer connected to this unit	✓	-
BD writer (external Blu-ray drive) connected to this unit	✓	✓
DVD player/ DVD recorder	✓*	-
Blu-ray player/ Blu-ray recorder	✓*	✓
DVD writer with playback function (CU-VD50)	✓	-

*Only for AVCHD compatible devices

Caution :

- DVDs that are created in AVCHD format cannot be played back on DVD players with standard quality. You may not be able to remove the disc from the player.

Digest Playback on a Blu-ray or DVD Player

You can play back a few seconds from each scene of the recorded videos in the created disc.

- 1 Load the created disc on a player.
- 2 Select “DIGEST PLAYBACK” on the TV.
 - The digest is played back continuously.



(The screen does not appear on this unit.)

Memo :

- To normal playback/To index menu
 - 1) Press the top menu button on the remote control of the player during digest playback.
 - 2) Select the desired item.
- “DIGEST PLAYBACK” menu is not available when the disc is created using the provided Everio MediaBrowser 4 BE software.
- Digest Playback is not available when playing back by connecting this unit to a DVD writer or external Blu-ray drive.

Deleting Unwanted Files

Delete unwanted videos and still images when the space in the recording media is running out.

Doing so frees up more space in the recording media.

“Deleting the Currently Displayed File” (p. 129)

“Deleting Selected Files” (p. 129)

Memo :

- Deleted files cannot be restored.
- When files in a playlist are deleted, the playlist changes.
- Files that are protected cannot be deleted.
Release protection before deleting the file.

“Protecting Files” (p. 130)

- Be sure to back up important files on a computer.

“Backing Up All Files” (p. 162)

Deleting the Currently Displayed File

Deletes the currently displayed file.

Caution :

- Deleted files cannot be restored.

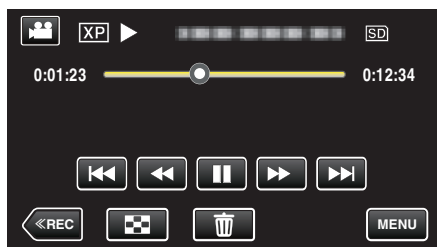

1 Tap .

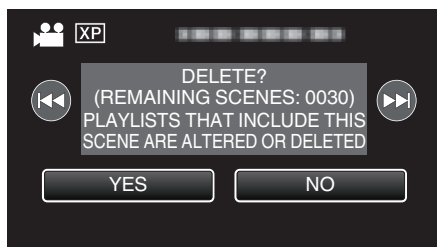

- While the video mode is shown in the image, the same operations apply for the still image mode.

2 Tap “YES”.



- Tap  /  to select the previous or next file.
- When no file remains, the screen returns to the index screen.

Deleting Selected Files









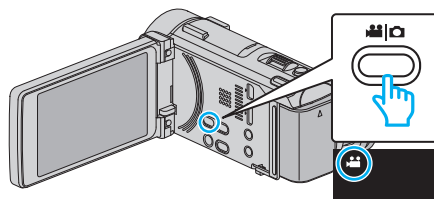

Deletes the selected files.

Caution :

- Deleted files cannot be restored.

1 Open the LCD monitor.



- Tap  or  to select the video or still image mode.
 - Tap  or  on the recording screen to display the mode switching screen.
Tap  to switch to the video mode .
Tap  to switch to the still image mode .
- (You can also use the  /  button on this unit.)

2 Tap “<<PLAY” to select the playback mode.

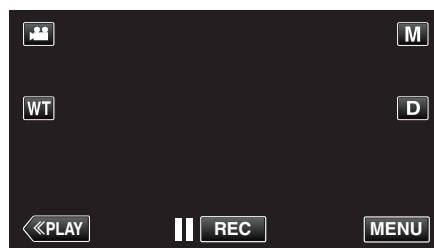

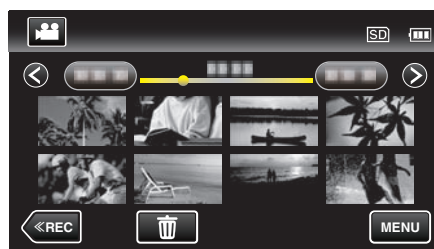

- While the video mode is shown in the image, the same operations apply for the still image mode.

3 Tap .

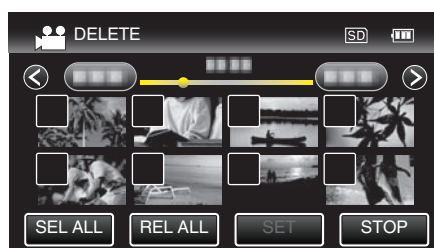

4 Tap on the files to delete.



-  appears on the selected files.
To remove  from a file, tap on the file again.
- Tap “SEL ALL” to select all files.
- Tap “REL ALL” to release all selections.

- <Grouped Files>

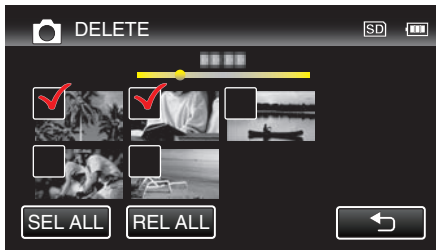

Still images that are recorded continuously within 2 seconds or with the continuous shooting mode will be grouped together. Only the first recorded file is shown and the group is displayed with a green frame. When this is tapped, an index screen of the grouped files appears. Tap on the files to delete, then tap “←”.

- 5 Tap “SET”.

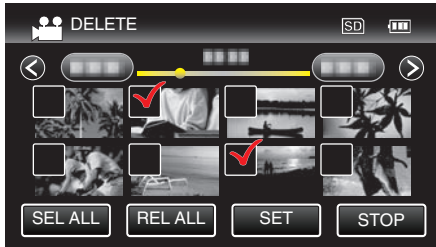

- 6 Tap “EXECUTE” to confirm the deletion.

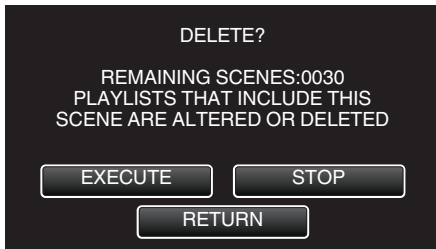

- After deleting is complete, tap “OK”.
- To cancel the deletion, tap “QUIT”.

Protecting Files

Prevent important videos/still images from being deleted accidentally by protecting them.

“Protecting/Releasing Protection of the Currently Displayed File” (p. 130)

“Protecting/Releasing Protection of Selected Files” (p. 131)

Caution :

- When the recording media is formatted, even the protected files will be deleted.

Protecting/Releasing Protection of the Currently Displayed File

Protects or releases protection of the currently displayed file.

- 1 Tap “MENU”.

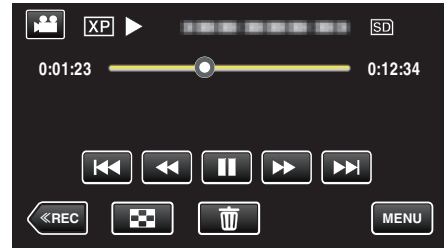

- 2 Tap “PROTECT/CANCEL”.

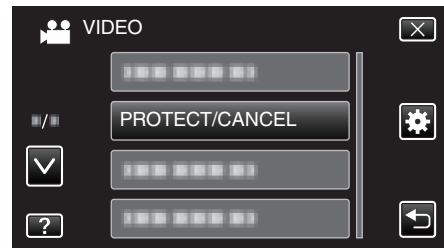

- 3 Tap “YES”.

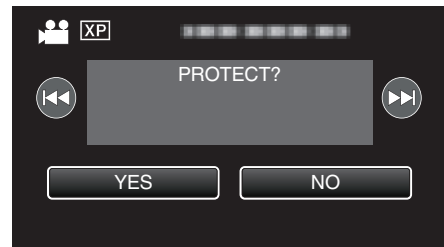

- Tap ◀▶ to select the previous or next file.
- After setting, tap “OK”.

Protecting/Releasing Protection of Selected Files

Protects or releases protection of the selected files.

1 Open the LCD monitor.

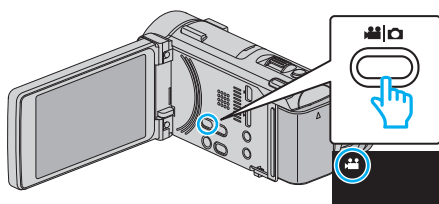

- Tap or to select the video or still image mode.
- Tap or on the recording screen to display the mode switching screen.
Tap to switch to the video mode .
- Tap to switch to the still image mode .
- (You can also use the / button on this unit.)

2 Tap “<<PLAY” to select the playback mode.

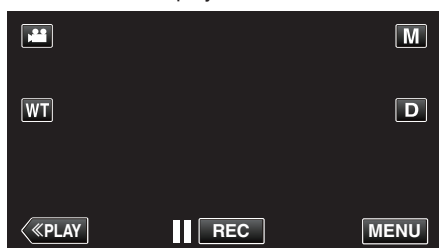

3 Tap “MENU”.

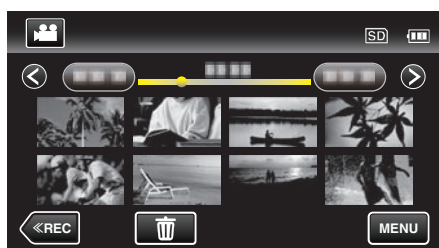

4 Tap “PROTECT/CANCEL”.

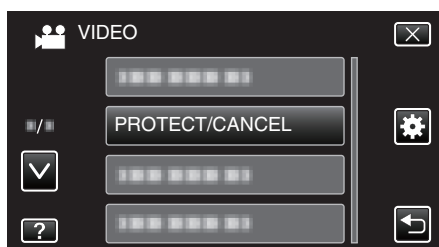

5 Tap on the files to protect or release protection of.

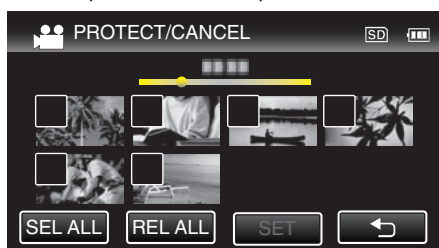

- appears on the selected files.
To remove from a file, tap on the file again.
- and are displayed on the files that are already protected.
To release protection of a file, tap on the file such that is removed.
- Tap “SEL ALL” to select all files.
- Tap “REL ALL” to release all selections.

• <Grouped Files>

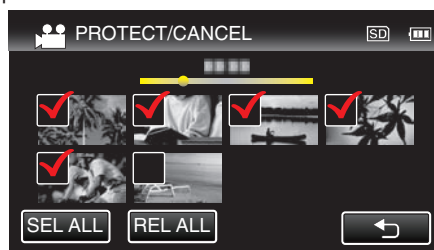

Still images that are recorded continuously within 2 seconds or with the continuous shooting mode will be grouped together. Only the first recorded file is shown and the group is displayed with a green frame. When this is tapped, an index screen of the grouped files appears. Tap on the files to protect or release protection of, then tap “<>”.

6 Tap “SET” to complete the setting.

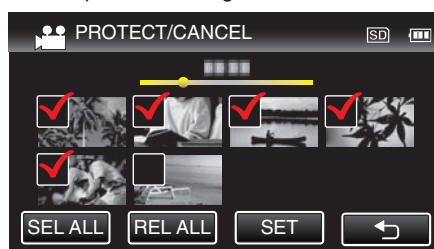

- Protect marks appear on the selected files.
Protect marks disappear from the deselected files.

Capturing a Still Image in the Video During Playback

You can capture still images of the scenes you like in the recorded videos.

- 1 Open the LCD monitor.

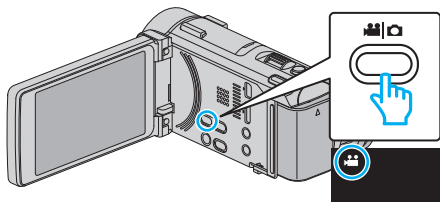

- Check if the recording mode is .
- If the mode is still image, tap on the recording screen to display the mode switching screen. Tap to switch the mode to video. (You can also use the / button on this unit.)

- 2 Tap “<<PLAY” to select the playback mode.

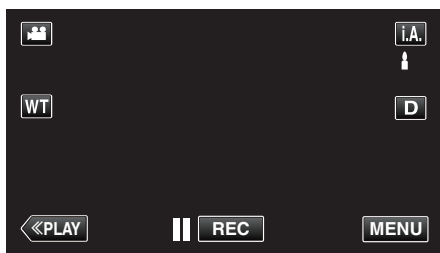

- 3 Tap on the desired video.



- 4 Tap pause at the desired scene during playback.

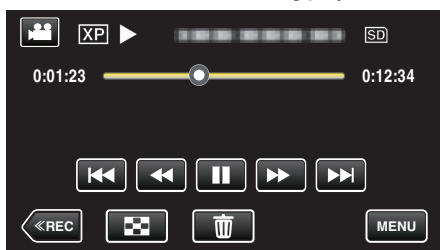

- After pausing the video, you can fine-tune the point to capture by tapping forward slow-motion and reverse slow-motion .

- 5 Press the SNAPSHOT button.

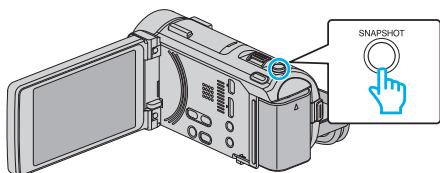

Memo :

- Still images are captured with a size of 1920x1080.

Capturing a Required Part in the Video (TRIMMING)

Select the required part of a video and save it as a new video file.

- The original video remains in its existing location.

- 1 Open the LCD monitor.

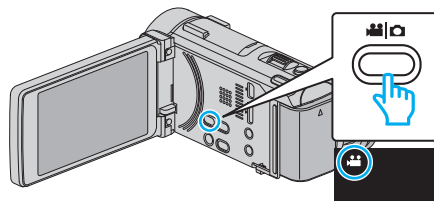

- Check if the recording mode is .
- If the mode is still image, tap on the recording screen to display the mode switching screen. Tap to switch the mode to video. (You can also use the / button on this unit.)

- 2 Tap “<<PLAY” to select the playback mode.

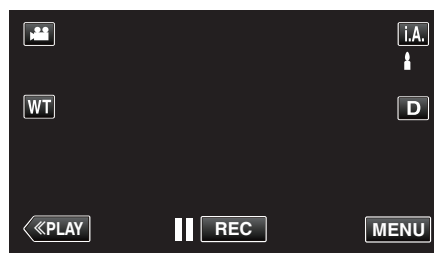

- 3 Tap “MENU”.

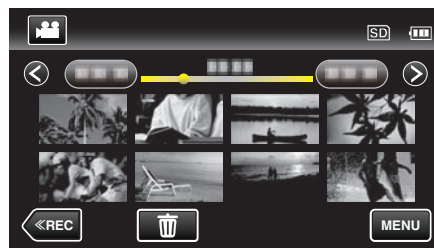

- 4 Tap “TRIMMING”.

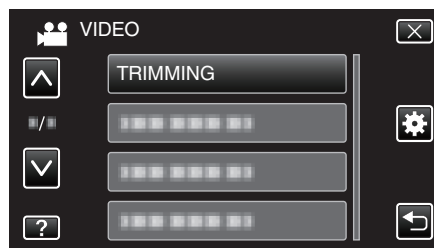

- 5 Tap the video to edit.



- 6 Tap to pause playback at the desired start point, then tap “A”.

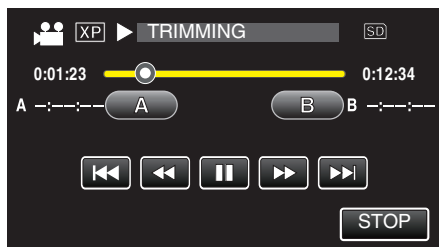

- When "A" is tapped, the start point is set.
- After setting the start point, tap ► to continue playback.

7 Tap || to pause playback at the desired end point, then tap "B".

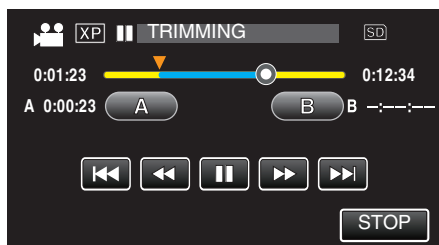

- When "B" is tapped, the end point is set.
- To reset the start or end point, tap "A" or "B" at the desired scene (position).

8 Tap "SET".

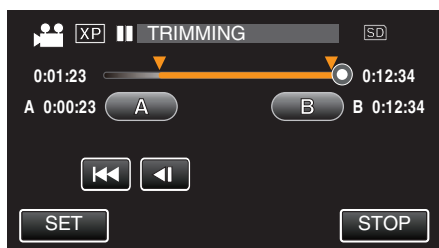

- When "SET" is tapped, the trimming area is confirmed.

9 Tap "YES".

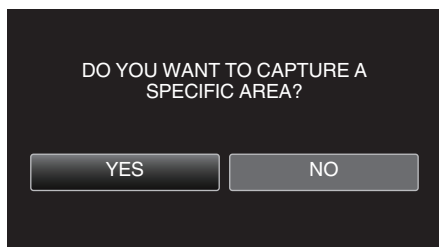

- After copying, tap "OK".
- When copying finishes, the copied file is added to the index screen.

Memo :

- The division point may deviate slightly from the selected scene.

Capturing Videos for Uploading to YouTube

Capture and copy a part of a recorded video (maximum 15 minutes) for uploading to YouTube, and save it as a YouTube video.

When capturing videos for YouTube, the duration cannot be longer than 15 minutes.

1 Open the LCD monitor.

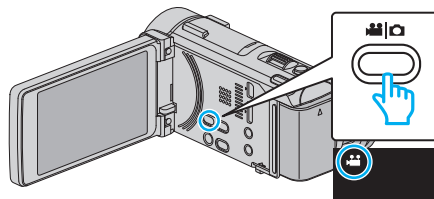

- Check if the recording mode is .
- If the mode is still image, tap on the recording screen to display the mode switching screen. Tap to switch the mode to video. (You can also use the button on this unit.)

2 Tap "<<PLAY" to select the playback mode.

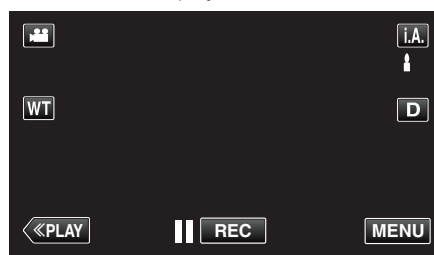

3 Tap "MENU".

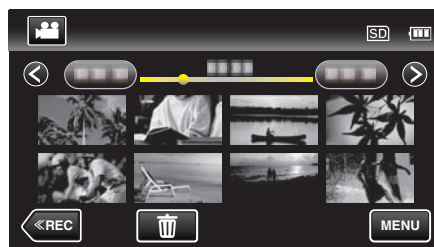

4 Tap "UPLOAD SETTINGS".

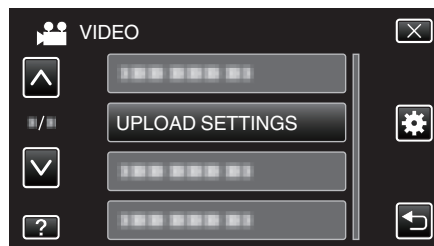

5 Tap the video to edit.



6 Tap "TRIM".

- When trimming is not necessary, tap "DO NOT TRIM".

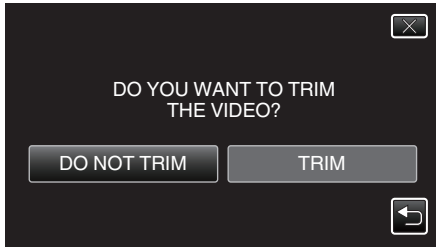

- If the selected video is more than 15 minutes, trimming is necessary.

7 Tap **||** to pause playback at the desired start point, then tap “A”.

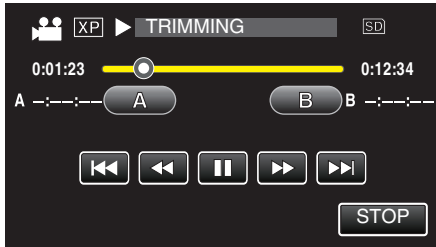

8 Tap **||** to pause playback at the desired end point, then tap “B”.

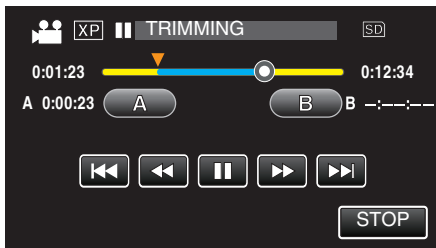

- To reset the start or end point, tap “A” or “B” at the desired scene (position).
- When capturing videos for YouTube, the duration cannot be longer than 15 minutes.

9 Tap “SET”.

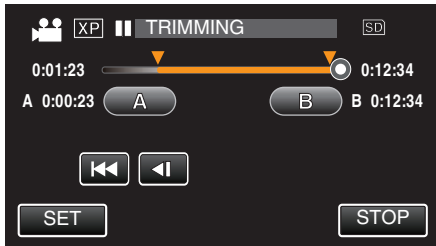

10 Tap “YES”.

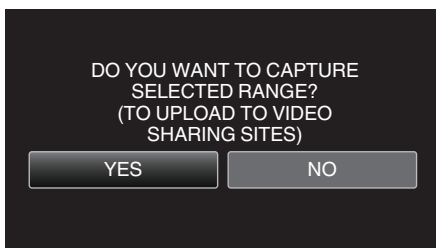

- After copying, tap “OK”.
- When copying finishes, the copied file is added to the index screen.
- To exit upload settings, tap “STOP” on the upload settings screen.

Memo : _____

- The division point may deviate slightly from the selected scene.

Uploading Videos to YouTube

You can upload your videos to YouTube using the provided software Everio MediaBrowser 4 BE. Install the software on your PC and connect this unit to the PC.

- For details on how to use the software, refer to the help file.

“Installing the Provided Software” (p. 161)

Trouble with Uploading Videos: _____

- Check if you have created an account with YouTube. (You need a YouTube account to upload files to YouTube.)
- Refer to “Q&A”, “Latest Information”, “Download Information”, etc. in “Click for Latest Product Info” in the help file of the provided software Everio MediaBrowser 4 BE.

Creating Playlists from the Recorded Videos

A list created by selecting your favorite videos from the recorded ones is called a playlist.

By creating a playlist, you can play back only your favorite videos in the order you like.

The original video file remains even when it is registered to a playlist.

- To create a new playlist

“Creating Playlists with Selected Files” (p. 135)

“Creating Playlists by Date” (p. 136)

- To edit or delete a created playlist

“Editing Playlists” (p. 137)

“Deleting Playlists” (p. 138)

Memo :

- When a video file is deleted or moved, the same file will be removed from the playlist.

Creating Playlists with Selected Files

Create a playlist by arranging the files one by one.

- 1 Open the LCD monitor.

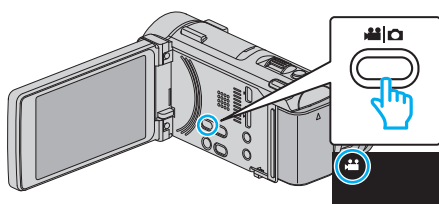

- Check if the recording mode is .
- If the mode is still image, tap on the recording screen to display the mode switching screen. Tap to switch the mode to video. (You can also use the button on this unit.)

- 2 Tap “<<PLAY” to select the playback mode.

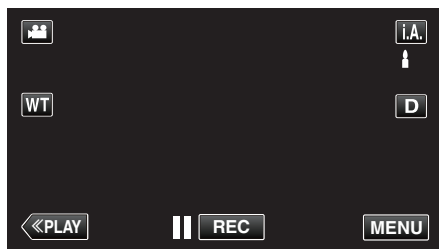

- 3 Tap “MENU”.

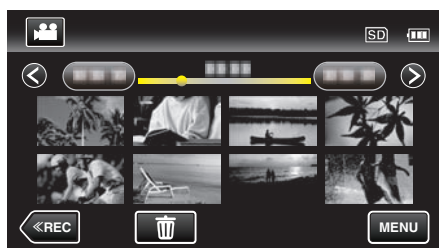

- 4 Tap “EDIT PLAYLIST”.

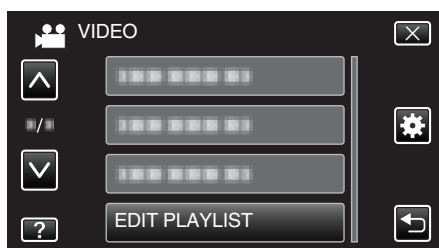

- 5 Tap “NEW LIST”.

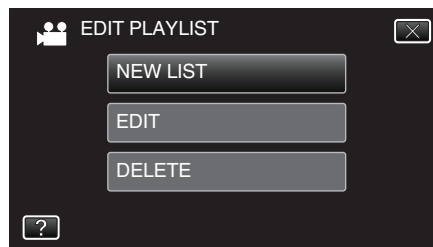

- 6 Tap “CREATE FROM SCENE”.

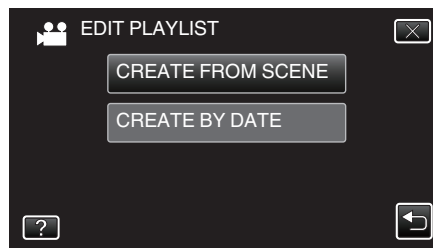

- 7 Tap on the video to add to playlist.



- appears on the selected video. Tap to deselect.
- Tap on the selected video again to check the video. After checking, tap .
- Tap or to move the zoom lever to display the previous/next video.
- indicates the size of the video.

- 8 Tap “ADD”, and insert the video image.



- Repeat steps 7-8 and arrange the videos in the playlist.
- To change the position of a video in the playlist (lower row), select the insertion point with / after step 7 and tap “ADD”.
- appears when the inserted video is selected. Tap to deselect.
- Tap on the selected video again to check the video. After checking, tap .
- To delete of a video in the playlist (lower row), tap the video, then tap “CANCEL”.
- indicates the size of the video.

- 9 After arranging, tap “SAVE”.



- 10 Tap “YES”.



Memo :

- Tap X on each screen to exit the menu.

Creating Playlists by Date

Create a playlist by arranging multiple files according to recording date.

- 1 Open the LCD monitor.

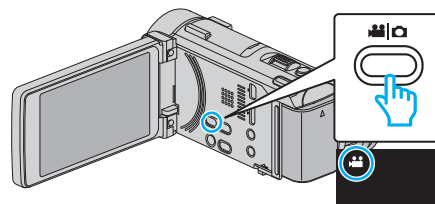

- Check if the recording mode is .
- If the mode is still image, tap on the recording screen to display the mode switching screen. Tap to switch the mode to video. (You can also use the button on this unit.)

- 2 Tap "<<PLAY" to select the playback mode.

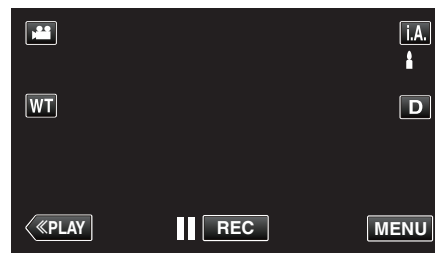

- 3 Tap "MENU".

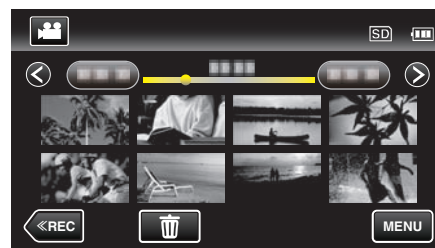

- 4 Tap "EDIT PLAYLIST".

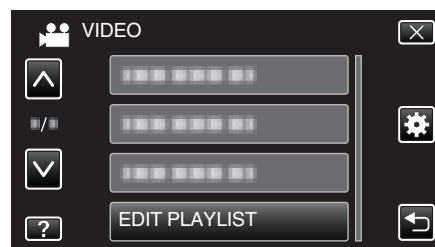

- 5 Tap "NEW LIST".

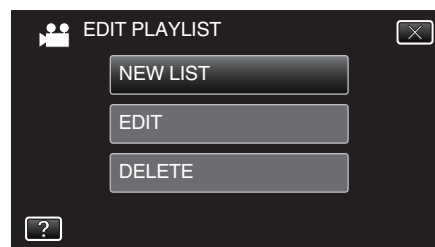

- 6 Tap "CREATE BY DATE".

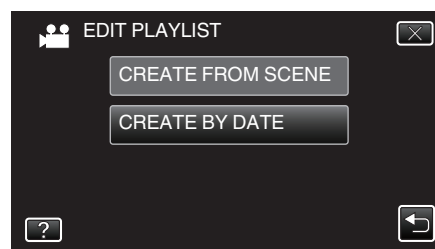

- 7 Tap on the video of the date to add to playlist.

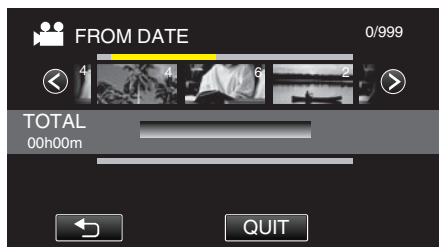

- ▶ appears on the selected video. Tap ↵ to deselect.
- Tap on the selected video again to check all the videos of the same date. After checking, tap ↵.
- Tap </> or move the zoom lever to display the previous/next video.
- The number on the video indicates the number of videos recorded on the same day.

8 Tap "ADD", and insert the video image.

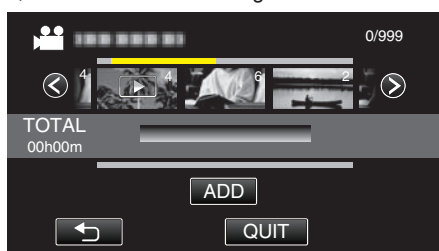

- Repeat steps 7-8 and arrange the videos in the playlist.
- To change the position of a video in the playlist (lower row), select the insertion point with ←/→ after step 7 and tap "ADD".
- ▶ appears when the inserted video is selected. Tap ↵ to deselect.
- Tap on the selected video again to check all the videos of the same date. After checking, tap ↵.
- To delete a video in the playlist (lower row), tap the video, then tap "CANCEL".

9 After arranging, tap "SAVE".

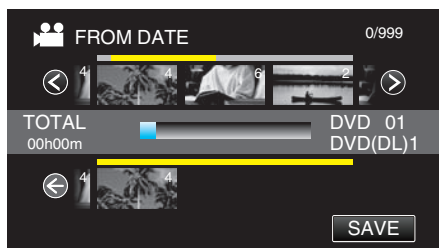

10 Tap "YES".

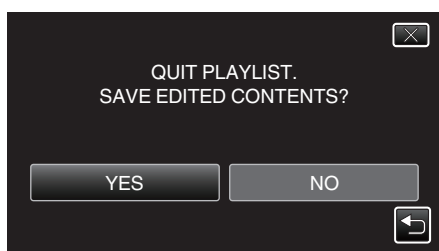

Memo :

- Tap X on each screen to exit the menu.

Editing Playlists

You can change the content of a created playlist. However, the playlists created from Digest Playback cannot be changed.

1 Open the LCD monitor.

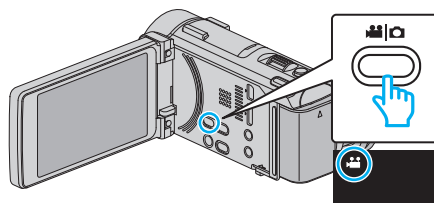

- Check if the recording mode is 📹.
- If the mode is 📷 still image, tap 📷 on the recording screen to display the mode switching screen. Tap 📹 to switch the mode to video. (You can also use the 📹/📷 button on this unit.)

2 Tap "<<PLAY" to select the playback mode.

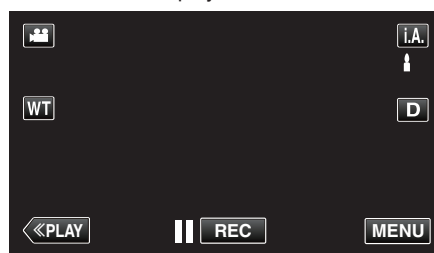

3 Tap "MENU".

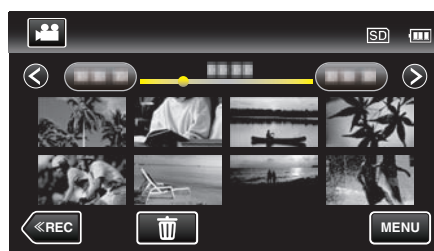

4 Tap "EDIT PLAYLIST".

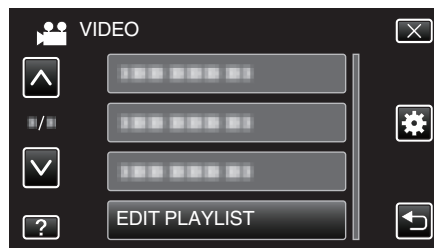

5 Tap "EDIT".

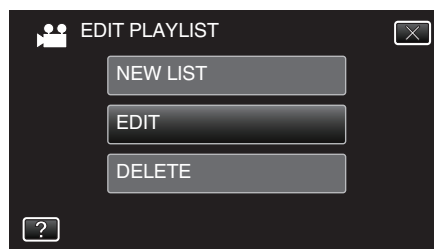

6 Tap on the playlist to edit, and tap "NEXT".

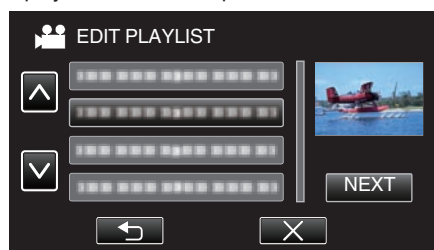

7 Tap on the video (upper row) to arrange in the playlist.

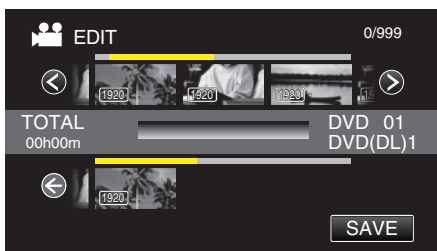

- ▶ appears on the selected video. Tap ↵ to deselect.
- Tap on the selected video again to check the video. After checking, tap ↵.
- Tap <> or move the zoom lever to display the previous/next video.
- 1920 indicates the size of the video.

8 Tap "ADD", and insert the video image.

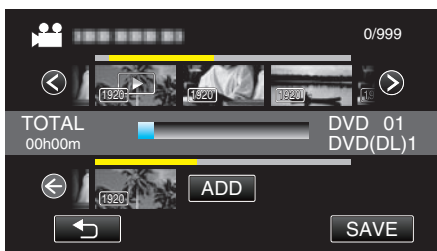

- Repeat steps 7-8 and arrange the videos in the playlist.
- To change the position of a video in the playlist (lower row), select the insertion point with ←/→ after step 7 and tap "ADD".
- ▶ appears when the inserted video is selected. Tap ↵ to deselect.
- Tap on the selected video again to check the video. After checking, tap ↵.
- To delete of a video in the playlist (lower row), tap the video, then tap "CANCEL".
- 1920 indicates the size of the video.

9 After arranging, tap "SAVE".

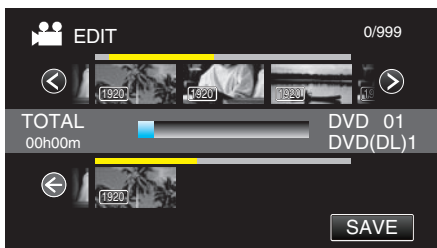

10 Tap "YES".



- Memo :**
- Tap X on each screen to exit the menu.

Deleting Playlists

Delete the playlists that you have created.

1 Open the LCD monitor.

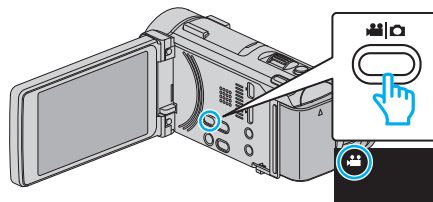

- Check if the recording mode is 📹.
- If the mode is 📷 still image, tap 📷 on the recording screen to display the mode switching screen. Tap 📹 to switch the mode to video. (You can also use the 📷/📹 button on this unit.)

2 Tap "<<PLAY" to select the playback mode.

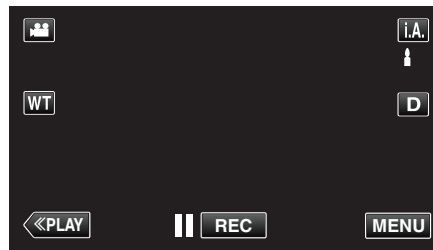

3 Tap "MENU".

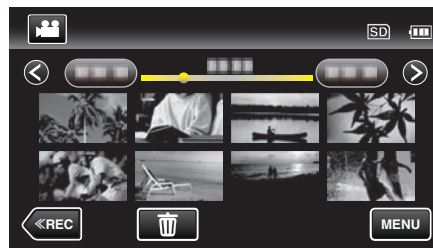

4 Tap "EDIT PLAYLIST".

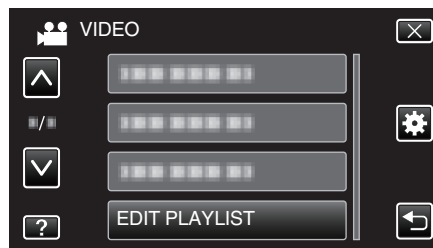

5 Tap "DELETE".

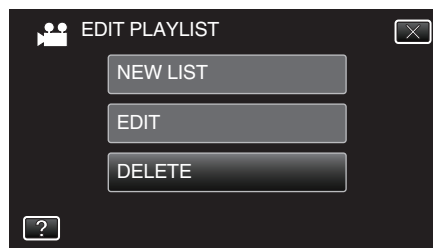

6 Tap on the playlist to delete, and tap "NEXT".

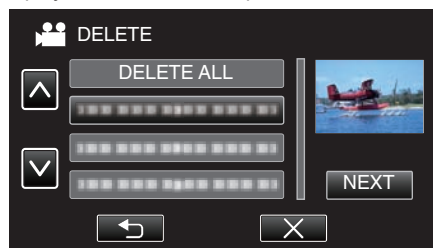

- All created playlists will be deleted when "DELETE ALL" is selected.
- 7 Tap "YES" to confirm the deletion.

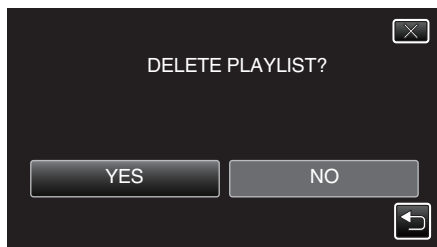

- After deleting, tap "OK".
- After deleting is complete, the screen returns to the delete playlist selection screen.

Memo :

- Tap X on each screen to exit the menu.

Creating Discs with a DVD Writer

You can copy the recorded files to discs or play back the created discs using an optional DVD writer.

Compatible DVD Writers

Product Name	Description
DVD Writer • CU-VD3	• Enables the images recorded on this unit to be copied to a DVD without using a PC.
DVD Writer • CU-VD50	• Creates DVDs and functions as an external DVD drive when connected to a PC. In addition, created DVDs can be played back by connecting the CU-VD50 to a TV.

Creating Discs with a DVD Writer

■ Preparing a DVD Writer

"Preparing a DVD Writer (CU-VD3)" (p. 140)

"Preparing a DVD Writer (CU-VD50)" (p. 140)

■ Copying to Discs

"Copying All Files" (p. 141)

"Copying Files by Date" (p. 142)

"Copying Selected Playlists" (p. 143)

"Copying Selected Files" (p. 144)

■ Other Operations

"Playing Back with a DVD Writer" (p. 145)

Memo :

- Discs created on this unit are saved in the AVCHD format. Play back on an AVCHD compatible device (such as Blu-ray recorder). In addition, discs in DVD-Video format cannot be created.
- Images recorded in UXP mode cannot be copied to a DVD writer.
- When there are many files to back up, it may take time for the backup to be completed. Wait for a while as the access lamp appears blinking, which indicates normal operation.
- Date and time information as saved as subtitles in the created discs.

Preparing a DVD Writer (CU-VD3)

- 1 Remove the AC adapter and battery pack from this unit.
- 2 Open the LCD monitor.

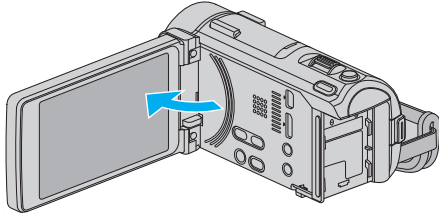

- 3 Connect the USB cable and the AC adapter.

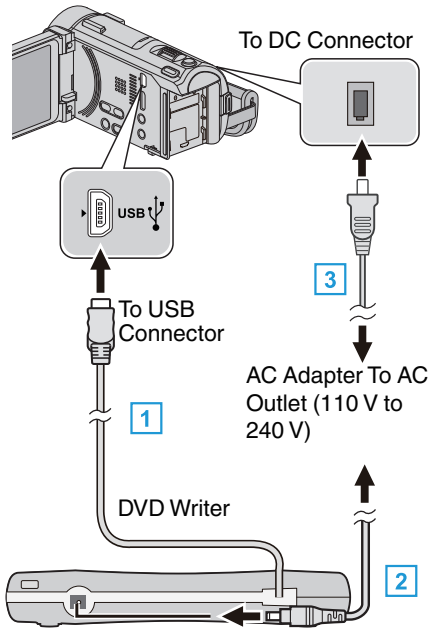

- 1 Connect the USB cable of the DVD writer to this unit.
 - 2 Connect the AC adapter of the DVD writer.
- Turn on the DVD writer.
 - 3 Connect the AC adapter to this unit.
 - This unit powers on automatically when the AC adapter is connected.
 - This unit turns on and the "BACK-UP" menu appears.
 - While the USB cable is connected, the "BACK-UP" menu is displayed.
 - Refer also to the instruction manual of the DVD writer.

- 4 Insert a new disc.

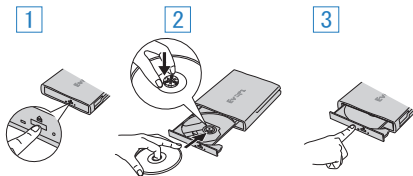

- 1 Press the eject button to open the disc tray.
- 2 Pull out the tray completely and load a new disc properly.
- 3 Push the disc tray in until it clicks into place.

Caution : _____

- Be sure to turn off the power when connecting the devices. Otherwise, electric shocks or malfunctions may occur.

Preparing a DVD Writer (CU-VD50)

- 1 Remove the AC adapter and battery pack from this unit.
- 2 Open the LCD monitor.

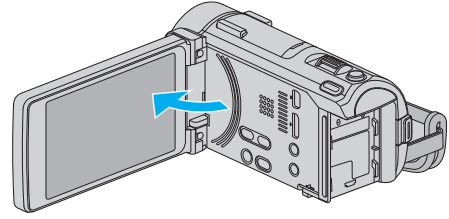

- 3 Connect the USB cable and the AC adapter.

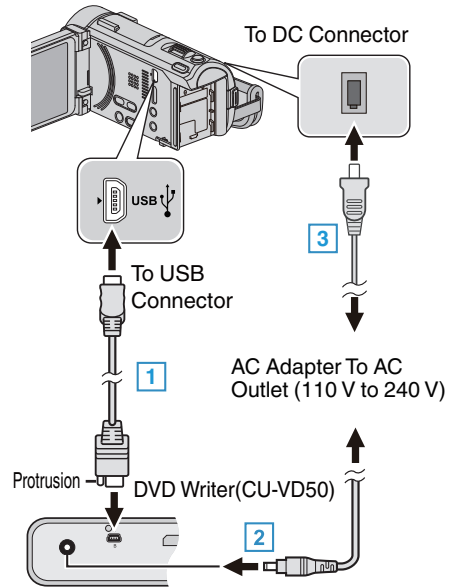

- 1 Connect the USB cable provided with the DVD writer.
 - 2 Connect the AC adapter of the DVD writer.
- Turn on the DVD writer.
 - 3 Connect the AC adapter to this unit.
 - This unit powers on automatically when the AC adapter is connected.
 - This unit turns on and the "BACK-UP" menu appears.
 - While the USB cable is connected, the "BACK-UP" menu is displayed.
 - Refer also to the instruction manual of the DVD writer.
- 4 Insert a new disc.

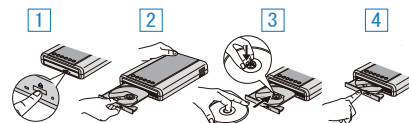

- 1 Press the eject button.
- 2 Pull out the disc tray.
- 3 Pull out the tray completely and load a new disc properly.
- 4 Push the disc tray in until it clicks into place.

Caution : _____

- Be sure to turn off the power when connecting the devices. Otherwise, electric shocks or malfunctions may occur.

Memo : _____

- All buttons on the DVD writer CU-VD50, other than the power and eject buttons, will not work when connected to this unit.

Creating a Disc

- 1 Prepare a DVD writer.
 - Insert a new disc into the DVD writer.
 - “Preparing a DVD Writer (CU-VD3)” (p. 140)
 - “Preparing a DVD Writer (CU-VD50)” (p. 140)
- 2 Copy files to the disc with the following methods.
 - “Copying All Files” (p. 141)
 - “Copying Files by Date” (p. 142)
 - “Copying Selected Playlists” (p. 143)
 - “Copying Selected Files” (p. 144)

Copying All Files

All videos or still images recorded on this unit will be copied. You can also select and copy only the videos or still images that have never been copied.

- 1 Select video or still image mode.
- 2 Tap “CREATE FROM ALL” (video) or “SAVE ALL” (still image).

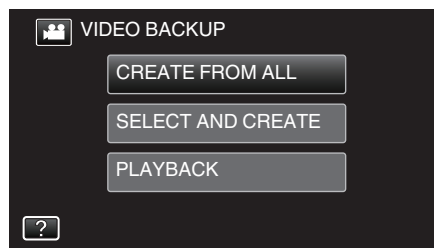

- While the video mode is shown in the image, the same operations apply for the still image mode.
- Tap the camera icon to switch between the video (60i) and still image modes.

- 3 Tap the desired method.

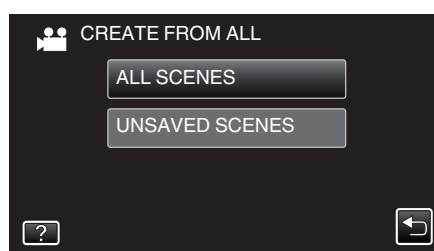

- While the video mode is shown in the image, the same operations apply for the still image mode.
- **“ALL SCENES” (video)/“ALL IMAGES” (still image):**
All videos or still images in this unit are copied.
- **“UNSAVED SCENES” (video)/“UNSAVED IMAGES” (still image):**
Videos or still images that have never been copied are automatically selected and copied.

- 4 Tap “EXECUTE”.

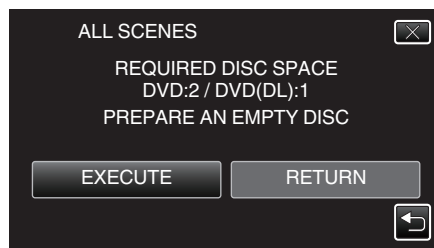

- The number of discs required to copy the files is displayed. Prepare the discs accordingly.

5 Tap "AUTO" or "BY DATE". (👤 mode only)



- When "AUTO" is selected, videos with similar recording dates are displayed in groups.
- When "BY DATE" is selected, videos are displayed according to recording dates.

6 Tap "EXECUTE".

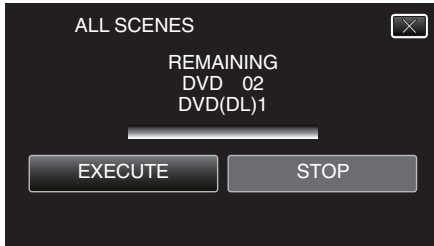

- When "INSERT THE NEXT DISC TO CREATE OR PRESS STOP TO EXIT" appears, change the disc.

7 Tap "OK" when "COMPLETED" is displayed.

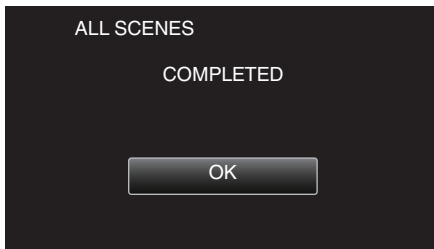

8 Press and hold the ⏻ button for 2 seconds or more to turn off this unit and disconnect the USB cable.

Caution :

- Do not turn off the power or remove the USB cable until copying is complete.
- Files that are not on the index screen during playback cannot be copied. Special files cannot be copied either.
- All DVDs will be finalized automatically. Files cannot be added to the DVD-R/DVD-RW later.

Memo :

- To check the created disc, refer to "Playing Back with a DVD Writer" (p. 145).

"Playing Back with a DVD Writer" (p. 145)

Copying Files by Date

Videos or still images are sorted and copied according to the date on which they were recorded.

1 Select video or still image mode.

2 Tap "SELECT AND CREATE" (video) or "SELECT AND SAVE" (still image).

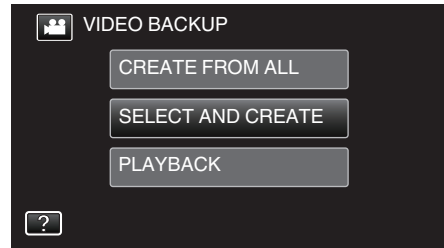

- While the video mode is shown in the image, the same operations apply for the still image mode.
- Tap 👤 to switch between the video (60i) and still image modes.

3 Tap "CREATE BY DATE" (video) or "SAVE BY DATE" (still image).

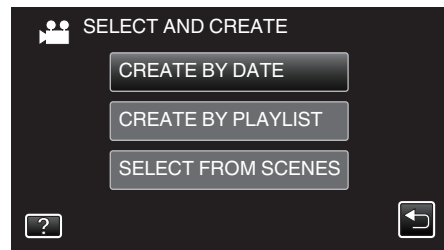

- While the video mode is shown in the image, the same operations apply for the still image mode.

4 Tap to select a recording date.

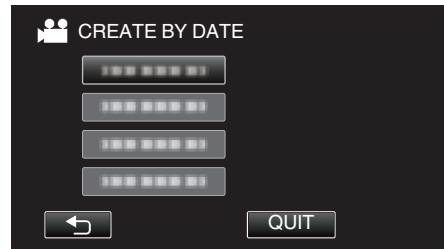

- You cannot select more than one recording date for copying. To copy files from multiple recording dates, it is recommended to copy by creating a playlist.

"Creating Playlists from the Recorded Videos" (p. 135)

"Copying Selected Playlists" (p. 143)

5 Tap "EXECUTE".



- The number of discs required to copy the files is displayed. Prepare the discs accordingly.
- Tap "CHECK" to check the content.

6 Tap "AUTO" or "BY DATE". (👤 mode only)

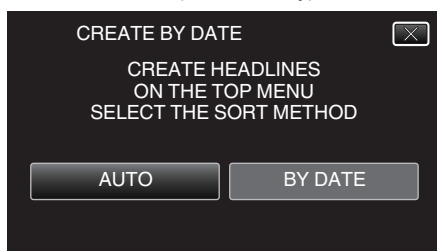

- When "AUTO" is selected, videos with similar recording dates are displayed in groups.
- When "BY DATE" is selected, videos are displayed according to recording dates.

7 Tap "EXECUTE".

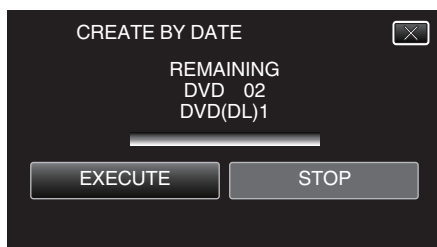

- When "INSERT THE NEXT DISC TO CREATE OR PRESS STOP TO EXIT" appears, change the disc.

8 Tap "OK" when "COMPLETED" is displayed.

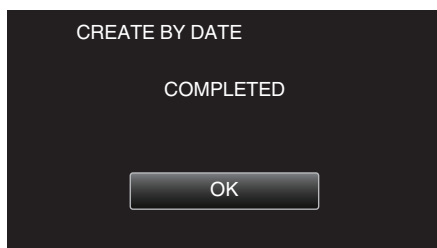

9 Press and hold the ⏻ button for 2 seconds or more to turn off this unit and disconnect the USB cable.

Caution :

- Do not turn off the power or remove the USB cable until copying is complete.
- Files that are not on the index screen during playback cannot be copied. Special files cannot be copied either.
- All DVDs will be finalized automatically. Files cannot be added to the DVD-R/DVD-RW later.

Memo :

- To check the created disc, refer to "Playing Back with a DVD Writer" (p. 145).

"Playing Back with a DVD Writer" (p. 145)

Copying Selected Playlists

Arrange and copy the created playlists in the order you like.

- 1 Select video mode.
- 2 Tap "SELECT AND CREATE".

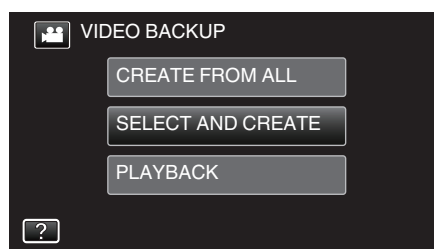

3 Tap "CREATE BY PLAYLIST".

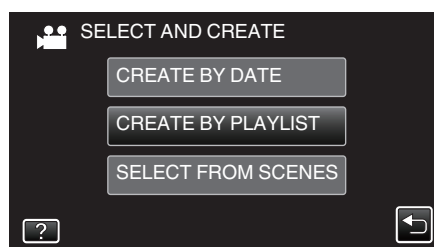

4 Tap on the playlist to copy to disc.

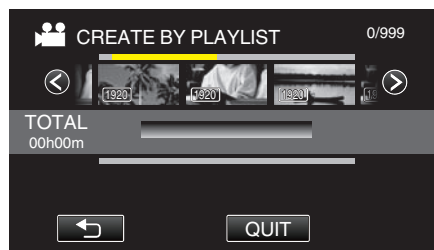

- ▶ appears on the selected playlist (upper row). Tap ↵ to deselect.
- Tap on the selected playlist again to check the content of the playlist. After checking, tap ↵.
- Tap </> or move the zoom lever to display the previous/next playlist.

5 Tap "ADD" to insert a playlist.



- Repeat steps 4-5 and arrange the playlists.
- To change the position of a playlist (lower row), select the insertion point with ←/→ after step 4 and tap "ADD".
- ▶ appears when the inserted playlist is selected. Tap ↵ to deselect.
- Tap on the selected playlist again to check the content of the playlist. After checking, tap ↵.
- To delete of a video in the playlist (lower row), tap the video, then tap "CANCEL".

6 After arranging, tap "SAVE".

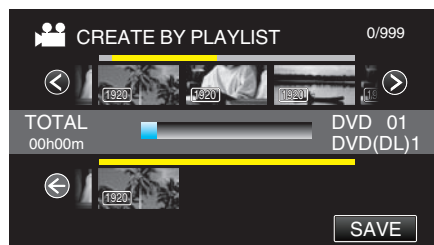

7 Tap "EXECUTE".



- The number of discs required to copy the files is displayed. Prepare the discs accordingly.
- Tap "CHECK" to check the content. After checking, tap ↶.

8 Tap "OK".

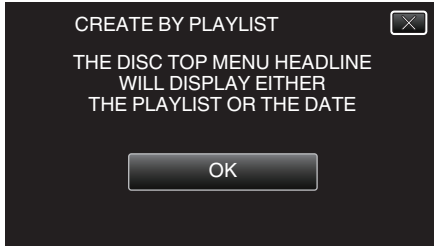

9 Tap "EXECUTE".

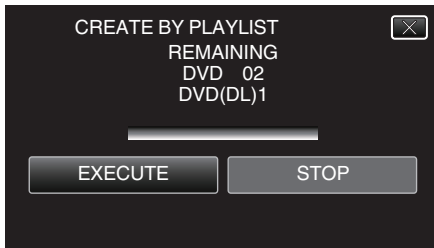

- When "INSERT THE NEXT DISC TO CREATE OR PRESS STOP TO EXIT" appears, change the disc.

10 Tap "OK" when "COMPLETED" is displayed.

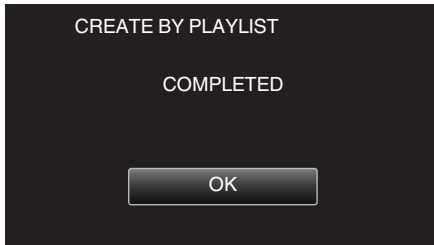

11 Press and hold the button for 2 seconds or more to turn off this unit and disconnect the USB cable.

Caution :

- Do not turn off the power or remove the USB cable until copying is complete.
- Files that are not on the index screen during playback cannot be copied. Special files cannot be copied either.
- All DVDs will be finalized automatically. Files cannot be added to the DVD-R/DVD-RW later.

Memo :

- A list of playlists is displayed on the top menu of the created DVD.
- To check the created disc, refer to "Playing Back with a DVD Writer" (p. 145).

"Playing Back with a DVD Writer" (p. 145)

- Playlists created from Digest Playback cannot be copied to discs.
- To create a playlist

"Creating Playlists from the Recorded Videos" (p. 135)

Copying Selected Files

Select and copy the desired videos or still images individually.

1 Select video or still image mode.

2 Tap "SELECT AND CREATE" (video) or "SELECT AND SAVE" (still image).

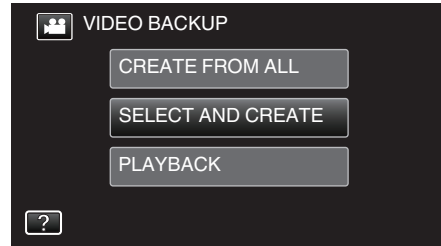

- While the video mode is shown in the image, the same operations apply for the still image mode.
- Tap to switch between the video (60i) and still image modes.

3 Tap "SELECT FROM SCENES" (video) or "SELECT FROM IMAGES" (still image).

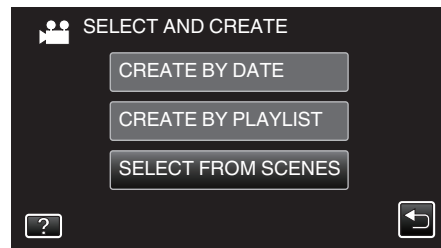

- While the video mode is shown in the image, the same operations apply for the still image mode.

4 Tap on the videos or still images to copy.

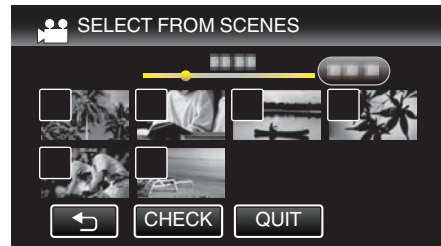

- A check mark appears on the selected file. To remove the check mark, tap on the file again.
- Tap "CHECK" to check the file. After checking, tap ↶.
- While the video mode is shown in the image, the same operations apply for the still image mode.

5 After selecting all the files, tap "SAVE".

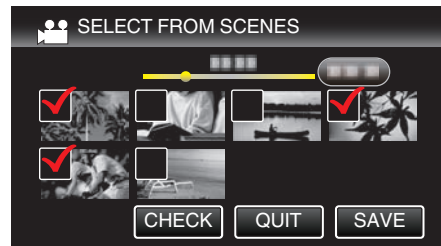

- While the video mode is shown in the image, the same operations apply for the still image mode.

6 Tap "EXECUTE".



- The number of discs required to copy the files is displayed. Prepare the discs accordingly.

7 Tap "AUTO" or "BY DATE". (👤 mode only)

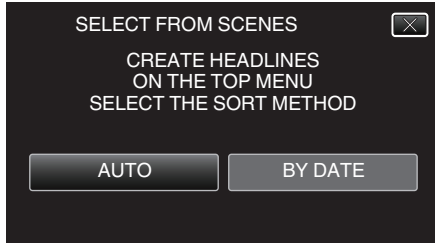

- When "AUTO" is selected, videos with similar recording dates are displayed in groups.
- When "BY DATE" is selected, videos are displayed according to recording dates.

8 Tap "EXECUTE".



- When "INSERT THE NEXT DISC TO CREATE OR PRESS STOP TO EXIT" appears, change the disc.

9 Tap "OK" when "COMPLETED" is displayed.

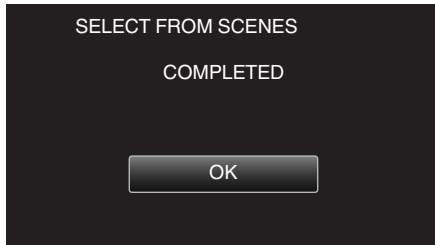

10 Press and hold the ⏻ button for 2 seconds or more to turn off this unit and disconnect the USB cable.

Caution :

- Do not turn off the power or remove the USB cable until copying is complete.
- Files that are not on the index screen during playback cannot be copied. Special files cannot be copied either.
- All DVDs will be finalized automatically. Files cannot be added to the DVD-R/DVD-RW later.

Memo :

- To check the created disc, refer to "Playing Back with a DVD Writer" (p. 145).
- "Playing Back with a DVD Writer" (p. 145)

Playing Back with a DVD Writer

You can play back the DVDs created on this unit.

1 Prepare a DVD writer.

- Insert the DVD to play back into the DVD writer. "Preparing a DVD Writer (CU-VD3)" (p. 140) "Preparing a DVD Writer (CU-VD50)" (p. 140)

2 Tap "PLAYBACK" in the BACK-UP menu.

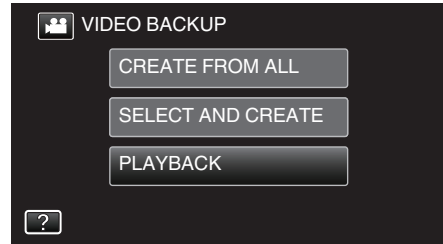

- An index screen (thumbnail display) of the videos in the disc appears.
- Tap 👤 to switch between the video (60i) and still image modes.

3 Tap on the file to start playback.

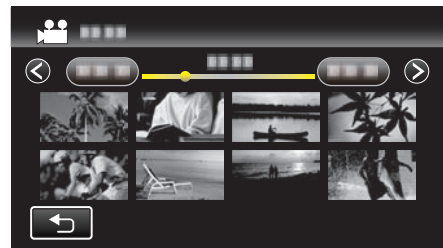

- Tap ⏪ to return to the "BACK-UP" menu.
- For details on video playback, refer to "Operation Buttons for Video Playback" (p. 119).
- To exit, stop playback and turn off the camcorder by pressing the ⏻ button for about 2 seconds. Then, disconnect the USB cable.

Memo :

- To play back the recorded image on TV, connect this unit via the HDMI mini cable or the AV Cord while this unit is connected to the DVD writer. "Connecting via the HDMI Mini Connector" (p. 126) "Connecting via the AV Connector" (p. 127)

Creating Discs with a BD Writer (External Blu-ray Drive)

You can copy the recorded files to discs or play back the created discs using an optional BD writer (external Blu-ray drive).

Compatible BD Writers (External Blu-ray Drives)

You can use BE08LU20 from LG. (as of February, 2012)

Creating Discs with a BD Writer (External Blu-ray Drive)

■ Preparing a BD Writer (External Blu-ray Drive)

“Preparing a BD Writer (External Blu-ray Drive)” (p. 146)

■ Copying to Discs

“Copying All Files” (p. 147)

“Copying Files by Date” (p. 149)

“Copying Selected Playlists” (p. 150)

“Copying Selected Files” (p. 152)

Select and copy the desired videos or still images individually.

■ Other Operations

“Playing Back with a BD Writer (External Blu-ray Drive)” (p. 153)

Memo :

- Discs in the DVD-Video format cannot be created.
- The recordable time on the disc varies according to the way of recording.
- When there are many files to back up, it may take time for the backup to be completed. Wait for a while as the access lamp appears blinking, which indicates normal operation.
- Date and time information as saved as subtitles in the created discs.

Preparing a BD Writer (External Blu-ray Drive)

Memo :

- When connecting to the BD writer (external Blu-ray drive), use a USB cable with Mini-A (Male) – B (Male) connectors. The USB cable provided with this unit cannot be used.

- To use the USB cable provided with the BD writer (external Blu-ray drive), purchase the following USB conversion cable.

Part number*: QAM0852-001 Mini-A (Male) – A (Female)

*Consult your nearest service center.

- 1 Remove the AC adapter and battery pack from this unit.
- 2 Open the LCD monitor.

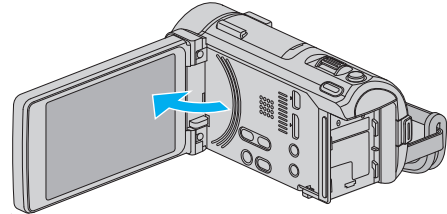

- 3 Connect the USB cable and the AC adapter.

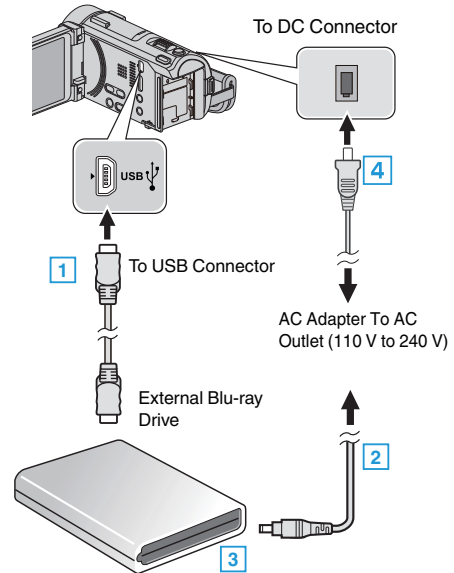

- 1 Connect the USB cable of the BD writer (external Blu-ray drive) to this unit.
- 2 Connect the AC adapter of the BD writer (external Blu-ray drive).
- 3 Turn on the BD writer (external Blu-ray drive).
- 4 Connect the AC adapter to this unit.
 - This unit powers on automatically when the AC adapter is connected.
 - This unit turns on and the “BACK-UP” menu appears.
 - While the USB cable is connected, the “BACK-UP” menu is displayed.
 - Refer also to the instruction manual of the BD writer (external Blu-ray drive).

4 Insert a new disc.

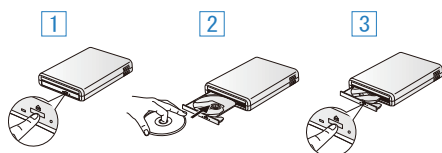

- 1 Press the eject button to open the disc tray.
- 2 Load a new disc properly.
- 3 Press the eject button to close the disc tray.

Caution :

- Be sure to turn off the power when connecting the devices. Otherwise, electric shocks or malfunctions may occur.

Creating a Disc

Creating a Disc

- 1 Preparing a BD Writer (External Blu-ray Drive)
 - Insert a new disc into the BD writer (external Blu-ray drive). “Preparing a BD Writer (External Blu-ray Drive)” (p. 146)
- 2 Copy files to the disc with the following methods.
 - “Copying All Files” (p. 147)
 - “Copying Files by Date” (p. 149)
 - “Copying Selected Playlists” (p. 150)
 - “Copying Selected Files” (p. 152)

Copying All Files

All videos or still images recorded on this unit will be copied. You can also select and copy only the videos or still images that have never been copied.

- 1 Select video or still image mode.
- 2 Tap “CREATE FROM ALL” (video) or “SAVE ALL” (still image).

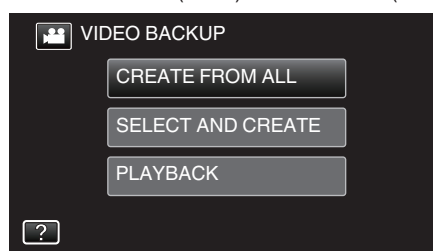

- While the video mode is shown in the image, the same operations apply for the still image mode.
- Tap to switch between the video (60i), video (60p), and still image modes. Switch to the mode in which you want to copy files.

- 3 Tap “Blu-ray DISC” or “DVD(AVCHD)”.

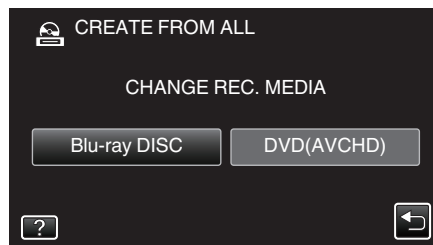

- The media changes to the tapped item. Select the appropriate setting according to the disc.
- Selecting “Blu-ray DISC” enables you to save videos in a Blu-ray disc in the high definition quality.
- Selecting “DVD(AVCHD)” enables you to save videos in a DVD in the high definition quality.

- 4 Tap the desired method.

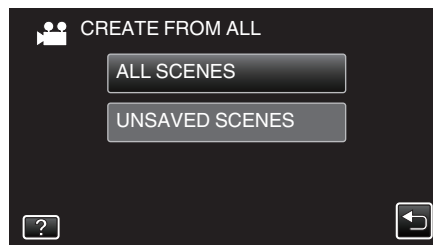

- **“ALL SCENES” (video)/“ALL IMAGES” (still image):**
All videos or still images in this unit are copied.
- **“UNSAVED SCENES” (video)/“UNSAVED IMAGES” (still image):**
Videos or still images that have never been copied are automatically selected and copied.

- 5 Tap “EXECUTE”.

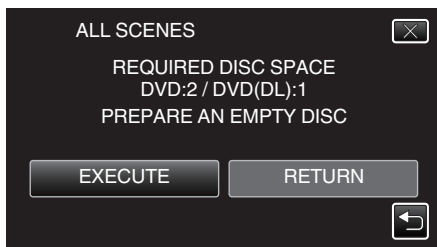

- The number of discs required to copy the files is displayed. Prepare the discs accordingly.

6 Tap "AUTO" or "BY DATE". (👤 mode only)

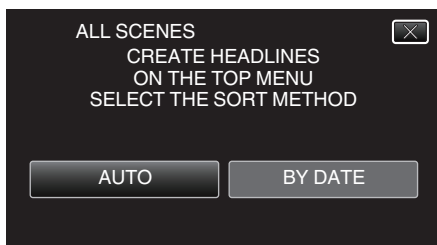

- When "AUTO" is selected, videos with similar recording dates are displayed in groups.
- When "BY DATE" is selected, videos are displayed according to recording dates.

7 Tap "EXECUTE".

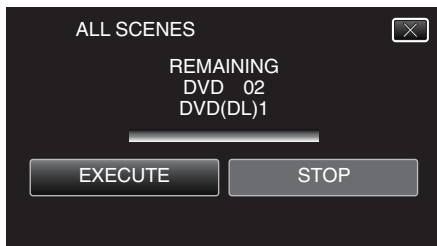

- When "INSERT THE NEXT DISC TO CREATE OR PRESS STOP TO EXIT" appears, change the disc.

8 Tap "OK" when "COMPLETED" is displayed.

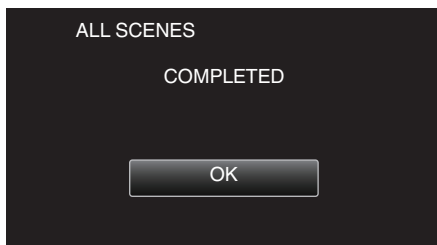

9 Press and hold the ⏻ button for 2 seconds or more to turn off this unit and disconnect the USB cable.

Caution :

- Do not turn off the power or remove the USB cable until copying is complete.
- Files that are not on the index screen during playback cannot be copied. Special files cannot be copied either.
- All DVDs will be finalized automatically. While files cannot be added to the DVD-R/DVD-RW later, files can still be added to the BD-R/BD-RE.
- DVDs that are created in "DVD(AVCHD)" format are playable only on AVCHD compatible devices.
- Videos that are recorded in the 60p mode (when "SYSTEM SELECT" is set to "60p") can only be copied to Blu-ray discs.
- Blu-ray discs containing videos that are recorded in the 60p mode (when "SYSTEM SELECT" is set to "60p") are playable only on AVCHD Progressive compatible devices.
- In case the videos are saved, upon completion of saving, the setting for the "SYSTEM SELECT" is automatically changed to the video mode (either 60i or 60p) that is saved. Change the settings as necessary. "SYSTEM SELECT" (📖 p. 179)

Memo :

- To check the created disc, refer to "Playing Back with a BD Writer (External Blu-ray Drive)" (📖 p. 153).
- "Playing Back with a BD Writer (External Blu-ray Drive)" (📖 p. 153)

Copying Files by Date

Videos or still images are sorted and copied according to the date on which they were recorded.

- 1 Select video or still image mode.
- 2 Tap "SELECT AND CREATE" (video) or "SELECT AND SAVE" (still image).

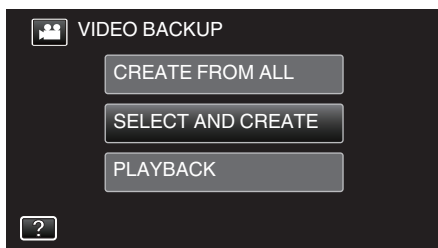

- While the video mode is shown in the image, the same operations apply for the still image mode.
- Tap to switch between the video (60i), video (60p), and still image modes. Switch to the mode in which you want to copy files.

- 3 Tap "Blu-ray DISC" or "DVD(AVCHD)".

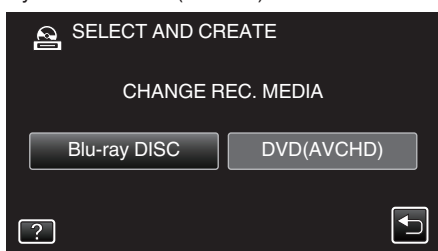

- The media changes to the tapped item. Select the appropriate setting according to the disc.
- Selecting "Blu-ray DISC" enables you to save videos in a Blu-ray disc in the high definition quality.
- Selecting "DVD(AVCHD)" enables you to save videos in a DVD in the high definition quality.

- 4 Tap "CREATE BY DATE" (video) or "SAVE BY DATE" (still image).

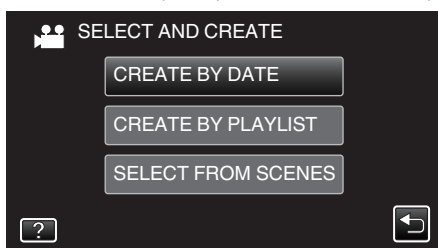

- While the video mode is shown in the image, the same operations apply for the still image mode.

- 5 Tap to select a recording date.



- If the desired date cannot be found, switch the mode to video (60i), video (60p), or still image accordingly in step 2.

Memo :

- You cannot select more than one recording date for copying. To copy files from multiple recording dates, it is recommended to copy by creating a playlist.
 "Creating Playlists from the Recorded Videos" (p. 135)
 "Copying Selected Playlists" (p. 150)

- 6 Tap "EXECUTE".



- The number of discs required to copy the files is displayed. Prepare the discs accordingly.

- 7 Tap "AUTO" or "BY DATE". (mode only)

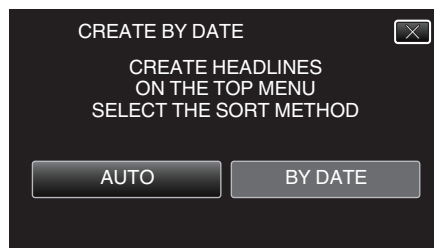

- When "AUTO" is selected, videos with similar recording dates are displayed in groups.
- When "BY DATE" is selected, videos are displayed according to recording dates.

- 8 Tap "EXECUTE".

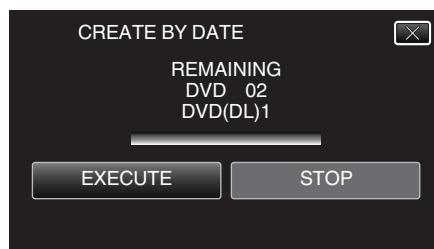

- When "INSERT THE NEXT DISC TO CREATE OR PRESS STOP TO EXIT" appears, change the disc.

- 9 Tap "OK" when "COMPLETED" is displayed.

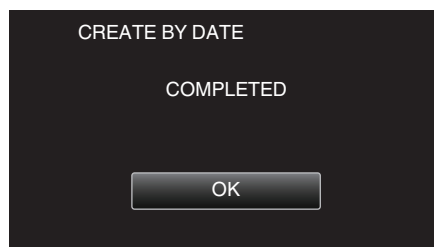

- 10 Press and hold the button for 2 seconds or more to turn off this unit and disconnect the USB cable.

Caution :

- Do not turn off the power or remove the USB cable until copying is complete.
- Files that are not on the index screen during playback cannot be copied. Special files cannot be copied either.
- All DVDs will be finalized automatically. While files cannot be added to the DVD-R/DVD-RW later, files can still be added to the BD-R/BD-RE.
- DVDs that are created in "DVD(AVCHD)" format are playable only on AVCHD compatible devices.
- Videos that are recorded in the 60p mode (when "SYSTEM SELECT" is set to "60p") can only be copied to Blu-ray discs.
- Blu-ray discs containing videos that are recorded in the 60p mode (when "SYSTEM SELECT" is set to "60p") are playable only on AVCHD Progressive compatible devices.
- In case the videos are saved, upon completion of saving, the setting for the "SYSTEM SELECT" is automatically changed to the video mode (either 60i or 60p) that is saved. Change the settings as necessary. "SYSTEM SELECT" (p. 179)

Memo :

- To check the created disc, refer to ““Playing Back with a BD Writer (External Blu-ray Drive)” (p. 153) ”.
- “Playing Back with a BD Writer (External Blu-ray Drive)” (p. 153)

Copying Selected Playlists

Arrange and copy the created playlists in the order you like.

- 1 Select video mode.
- 2 Tap “SELECT AND CREATE”.

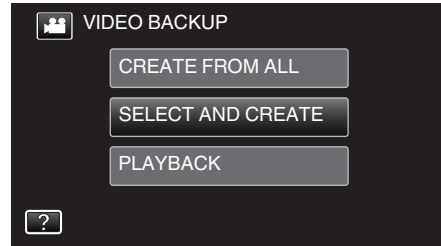

- Tap to switch between the video (60i), video (60p), and still image modes. Switch to the mode in which you want to copy files.

- 3 Tap “Blu-ray DISC” or “DVD(AVCHD)”.

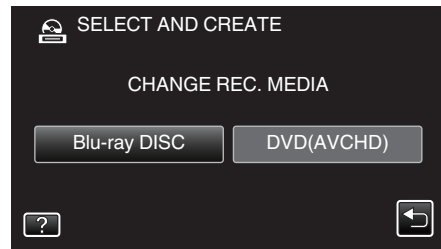

- The media changes to the tapped item. Select the appropriate setting according to the disc.
- Selecting “Blu-ray DISC” enables you to save videos in a Blu-ray disc in the high definition quality.
- Selecting “DVD(AVCHD)” enables you to save videos in a DVD in the high definition quality.

- 4 Tap “CREATE BY PLAYLIST”.

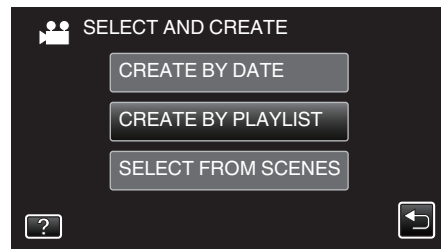

- 5 Tap on the playlist to copy to disc.

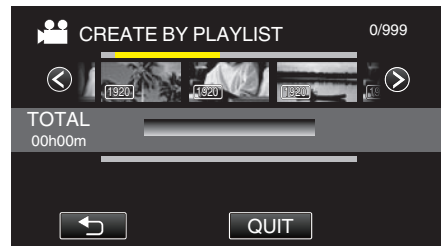

- appears on the selected playlist (upper row). Tap to deselect.
- Tap on the selected playlist again to check the content of the playlist. After checking, tap .
- Tap or move the zoom lever to display the previous/next playlist.
- If the desired playlist cannot be found, switch the mode to video (60i) or video (60p) accordingly in step 2.

- 6 Tap “ADD” to insert a playlist.

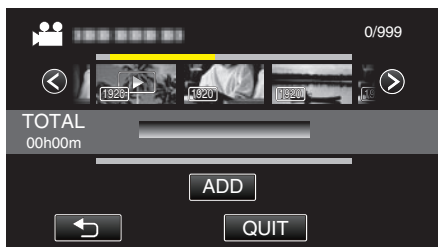

- Repeat steps 5-6 and arrange the playlists.
- To change the position of a playlist (lower row), select the insertion point with ←/→ after step 5 and tap "ADD".
- ▶ appears when the inserted playlist is selected. Tap ↵ to deselect.
- Tap on the selected playlist again to check the content of the playlist. After checking, tap ↵.
- To delete of a video in the playlist (lower row), tap the video, then tap "CANCEL".

7 After arranging, tap "SAVE".

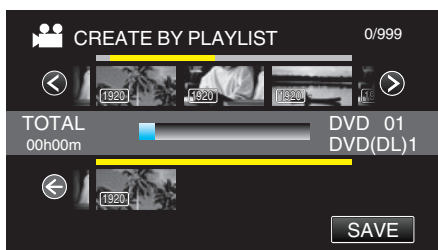

8 Tap "EXECUTE".

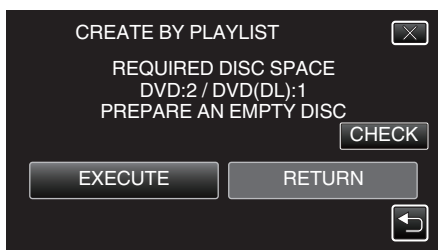

- The number of discs required to copy the files is displayed. Prepare the discs accordingly.
- Tap "CHECK" to check the content.

9 Tap "OK".

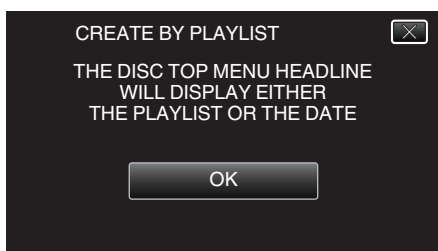

10 Tap "EXECUTE".

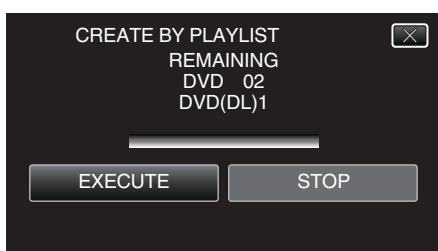

- When "INSERT THE NEXT DISC TO CREATE OR PRESS STOP TO EXIT" appears, change the disc.

11 Tap "OK" when "COMPLETED" is displayed.

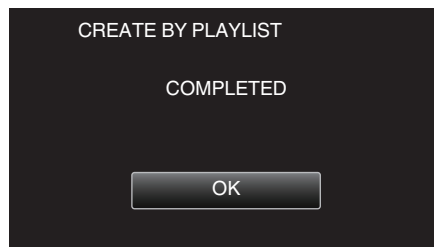

12 Press and hold the button for 2 seconds or more to turn off this unit and disconnect the USB cable.

Caution :

- Do not turn off the power or remove the USB cable until copying is complete.
- Files that are not on the index screen during playback cannot be copied. Special files cannot be copied either.
- All DVDs will be finalized automatically. While files cannot be added to the DVD-R/DVD-RW later, files can still be added to the BD-R/BD-RE.
- DVDs that are created in "DVD(AVCHD)" format are playable only on AVCHD compatible devices.
- Videos that are recorded in the 60p mode (when "SYSTEM SELECT" is set to "60p") can only be copied to Blu-ray discs.
- Blu-ray discs containing videos that are recorded in the 60p mode (when "SYSTEM SELECT" is set to "60p") are playable only on AVCHD Progressive compatible devices.
- In case the videos are saved, upon completion of saving, the setting for the "SYSTEM SELECT" is automatically changed to the video mode (either 60i or 60p) that is saved. Change the settings as necessary. "SYSTEM SELECT" (☞ p. 179)

Memo :

- A list of playlists is displayed on the top menu of the created DVD.
- To check the created disc, refer to "Playing Back with a BD Writer (External Blu-ray Drive)" (☞ p. 153).
- "Playing Back with a BD Writer (External Blu-ray Drive)" (☞ p. 153)
- To create a playlist "Creating Playlists from the Recorded Videos" (☞ p. 135)
- Playlists created from Digest Playback cannot be copied to discs.

Copying Selected Files

Select and copy the desired videos or still images individually.

- 1 Select video or still image mode.
- 2 Tap "SELECT AND CREATE" (video) or "SELECT AND SAVE" (still image).

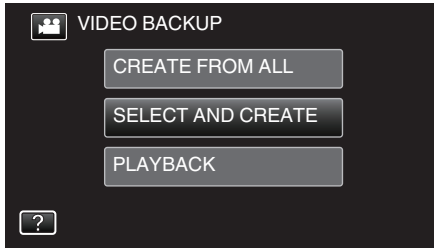

- While the video mode is shown in the image, the same operations apply for the still image mode.
- Tap to switch between the video (60i), video (60p), and still image modes. Switch to the mode in which you want to copy files.

- 3 Tap "Blu-ray DISC" or "DVD(AVCHD)".

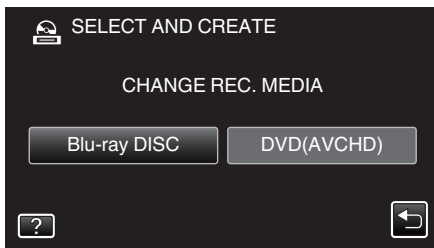

- The media changes to the tapped item. Select the appropriate setting according to the disc.
- Selecting "Blu-ray DISC" enables you to save videos in a Blu-ray disc in the high definition quality.
- Selecting "DVD(AVCHD)" enables you to save videos in a DVD in the high definition quality.

- 4 Tap "SELECT FROM SCENES" (video) or "SELECT FROM IMAGES" (still image).

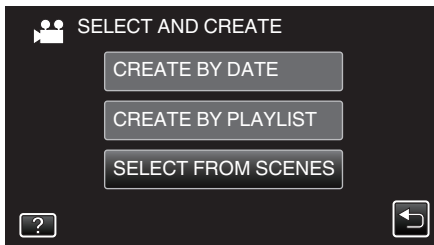

- While the video mode is shown in the image, the same operations apply for the still image mode.

- 5 Tap on the videos or still images to copy.

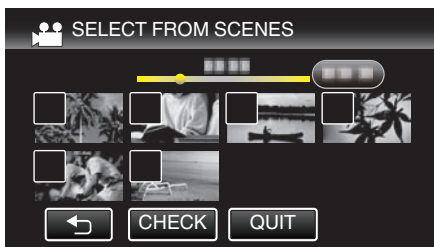

- A check mark appears on the selected file. To remove the check mark, tap on the file again.
- Tap "CHECK" to check the file. After checking, tap .
- If the desired video or still image cannot be found, switch the mode to video (60i), video (60p), or still image accordingly in step 2.

- 6 After selecting all the files, tap "SAVE".

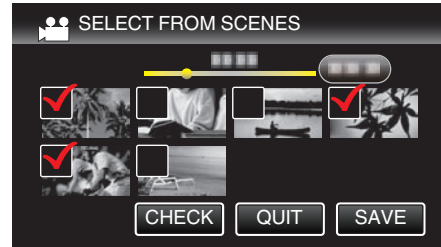

- 7 Tap "EXECUTE".



- The number of discs required to copy the files is displayed. Prepare the discs accordingly.

- 8 Tap "AUTO" or "BY DATE". (mode only)

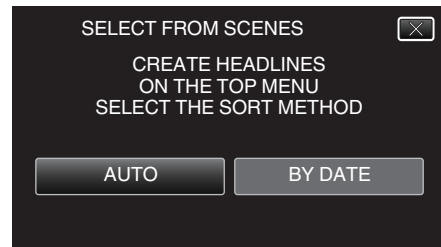

- When "AUTO" is selected, videos with similar recording dates are displayed in groups.
- When "BY DATE" is selected, videos are displayed according to recording dates.

- 9 Tap "EXECUTE".

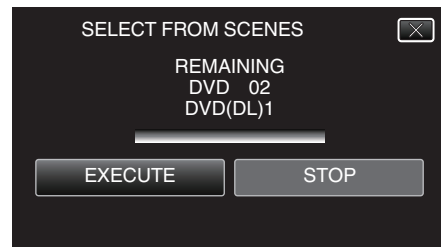

- When "INSERT THE NEXT DISC TO CREATE OR PRESS STOP TO EXIT" appears, change the disc.

- 10 Tap "OK" when "COMPLETED" is displayed.

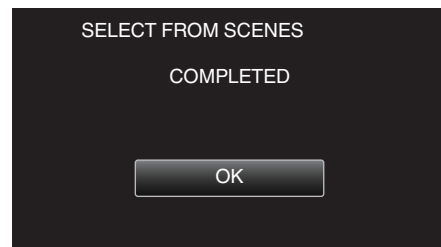

- 11 Press and hold the button for 2 seconds or more to turn off this unit and disconnect the USB cable.

Caution :

- Do not turn off the power or remove the USB cable until copying is complete.
- Files that are not on the index screen during playback cannot be copied. Special files cannot be copied either.
- All DVDs will be finalized automatically. While files cannot be added to the DVD-R/DVD-RW later, files can still be added to the BD-R/BD-RE.

- DVDs that are created in “DVD(AVCHD)” format are playable only on AVCHD compatible devices.
- Videos that are recorded in the 60p mode (when “SYSTEM SELECT” is set to “60p”) can only be copied to Blu-ray discs.
- Blu-ray discs containing videos that are recorded in the 60p mode (when “SYSTEM SELECT” is set to “60p”) are playable only on AVCHD Progressive compatible devices.
- In case the videos are saved, upon completion of saving, the setting for the “SYSTEM SELECT” is automatically changed to the video mode (either 60i or 60p) that is saved. Change the settings as necessary. “SYSTEM SELECT” (☞ p. 179)

Memo :

- To check the created disc, refer to ““Playing Back with a BD Writer (External Blu-ray Drive)” (☞ p. 153) ”.

“Playing Back with a BD Writer (External Blu-ray Drive)” (☞ p. 153)

Playing Back with a BD Writer (External Blu-ray Drive)

You can play back the Blu-ray discs created on this unit.

1 Preparing a BD Writer (External Blu-ray Drive)

- Insert the Blu-ray disc to play back into the BD writer (external Blu-ray drive).
“Preparing a BD Writer (External Blu-ray Drive)” (☞ p. 146)

2 Tap “PLAYBACK” in the BACK-UP menu.

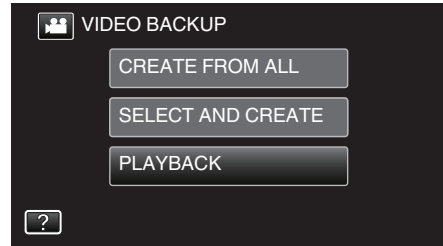

- An index screen (thumbnail display) of the videos in the disc appears.
- Tap to switch between the video (60i), video (60p), and still image modes. Switch to the mode in which you want to play back files.

3 Tap on the file to start playback.

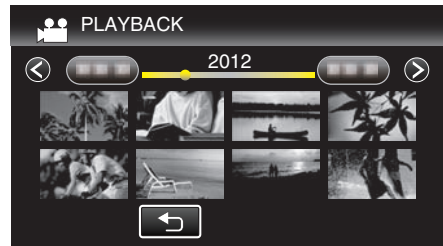

- For details on video playback, refer to ““Operation Buttons for Video Playback” (☞ p. 119) ”.
- “Operation Buttons for Video Playback” (☞ p. 119)
- To exit, stop playback and turn off the camcorder by pressing the button for about 2 seconds. Then, disconnect the USB cable.

Caution :

- In case the videos are played back, upon completion of the playback, the setting for the “SYSTEM SELECT” is automatically changed to the video mode (either 60i or 60p) that is played. Change the settings as necessary. “SYSTEM SELECT” (☞ p. 179)

Memo :

- To play back the recorded image on TV, connect this unit via the HDMI mini cable or the AV cord while this unit is connected to the BD writer (external Blu-ray drives).

“Connecting via the HDMI Mini Connector” (☞ p. 126)

“Connecting via the AV Connector” (☞ p. 127)

Creating a Disc Using a Connected Blu-ray Recorder

You can create discs using a Blu-ray recorder by connecting it to this unit using a USB cable.

- 1 Remove the AC adapter and battery pack from this unit.
- 2 Open the LCD monitor.

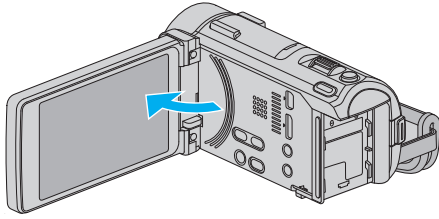

- 3 Connect to a Blu-ray recorder.

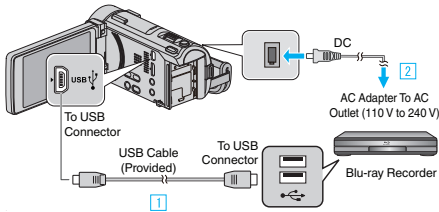

- 1 Connect using the provided USB cable.
- 2 Connect the AC adapter to this unit.
 - This unit powers on automatically when the AC adapter is connected.
 - Be sure to use the supplied AC adapter.

- 4 Tap “CONNECT TO OTHER”.

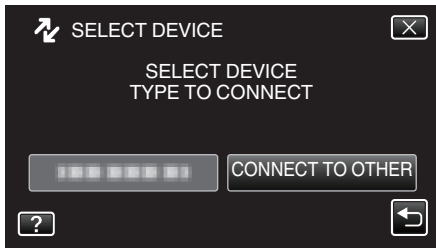

- Operations are to be performed on the Blu-ray recorder after the screen switches.

- 5 Perform dubbing on the Blu-ray recorder.
 - Refer also to the instruction manual of the Blu-ray recorder.
 - After dubbing is complete, disconnect the USB cable. Operations cannot be performed on this unit until the USB cable is disconnected.

Memo :

- To copy videos that are recorded in the 60p mode (when “SYSTEM SELECT” is set to “60p”), use an AVCHD Progressive compatible Blu-ray recorder.
- Videos that are recorded in the 60p mode (when “SYSTEM SELECT” is set to “60p”) can only be copied to Blu-ray discs.

Dubbing Files to a Disc by Connecting to a DVD Recorder

You can dub videos in standard quality by connecting to a DVD recorder.

- Refer also to the instruction manuals of the TV and DVD recorder.

- 1 Remove the AC adapter and battery pack from this unit.
- 2 Open the LCD monitor.

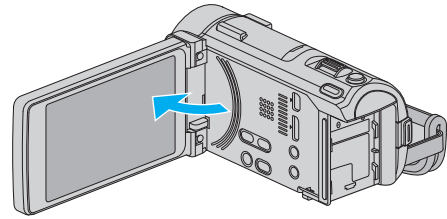

- 3 Connect to a DVD recorder.

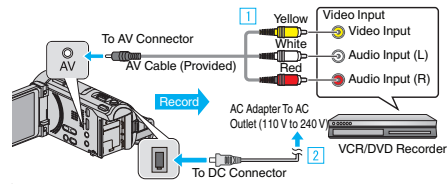

- 1 Connect using the provided AV cable.
 - This unit powers on automatically when the AC adapter is connected.
 - Be sure to use the supplied AC adapter.
- 2 Connect the AC adapter to this unit.

- 4 Tap “<<PLAY” to select the playback mode.

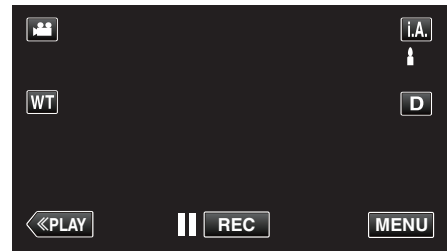

- 5 Prepare the TV/DVD recorder for recording.
 - Switch to a compatible external input.
 - Insert a disc (DVD-R, etc.) into the DVD recorder.

- 6 Prepare this unit for playback.
 - Set “VIDEO OUTPUT” in the “COMMON” menu to the aspect ratio (“4:3” or “16:9”) of the connecting TV.
 - “VIDEO OUTPUT” (☞ p. 203)

- 7 Start recording.
 - Start playback on this unit and press the record button on the recorder.
 - “Playing Back Videos” (☞ p. 119)
 - After playback is complete, stop the recording.

Memo :

- When there are many videos to dub, you can create a playlist in advance and play it back so that all your favorite videos can be dubbed at once.
 - “Creating Playlists with Selected Files” (☞ p. 135)
 - “Playing Back Playlists” (☞ p. 127)
- To include the recording date and time during dubbing, set “DISPLAY DATE/TIME” in the video playback menu to “ON”. Set “DISPLAY ON TV” in the common menu to “ON”.

Dubbing Files to a VHS Tape by Connecting to a VCR

You can dub videos in standard quality by connecting to a VCR.

- Refer also to the instruction manuals of the TV and VCR.

- 1 Remove the AC adapter and battery pack from this unit.
- 2 Open the LCD monitor.

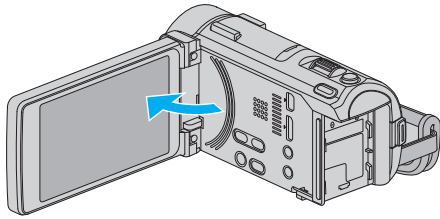

- 3 Connect to a VCR/DVD recorder.

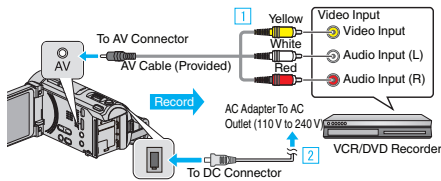

- 1 Connect using the provided AV cable.
- 2 Connect the AC adapter to this unit.
 - This unit powers on automatically when the AC adapter is connected.
 - Be sure to use the supplied AC adapter.

- 4 Tap "<<PLAY" to select the playback mode.

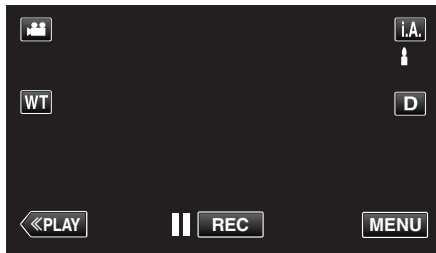

- 5 Prepare the TV/VCR for recording.
 - Switch to a compatible external input.
 - Insert a video tape.
- 6 Prepare this unit for playback.
 - Set "VIDEO OUTPUT" in the "COMMON" menu to the aspect ratio ("4:3" or "16:9") of the connecting TV.

"VIDEO OUTPUT" (☞ p. 203)
- 7 Start recording.
 - Start playback on this unit and press the record button on the recorder.

"Playing Back Videos" (☞ p. 119)

 - After playback is complete, stop the recording.

Memo :

- When there are many videos to dub, you can create a playlist in advance and play it back so that all your favorite videos can be dubbed at once.
- "Creating Playlists with Selected Files" (☞ p. 135)
- "Playing Back Playlists" (☞ p. 127)
- To include the recording date and time during dubbing, set "DISPLAY DATE/TIME" in the video playback menu to "ON". Set "DISPLAY ON TV" in the common menu to "ON".

Using a USB External Hard Disk Drive

You can copy video and still image files to a USB external hard disk drive from this unit. You can also play the files in the USB external hard disk drive on this unit.

- Refer also to the instruction manual of the external hard disk drive.

Compatible External Hard Disk Drives

You can use the "LaCie Hard Disk Sleek black design USB2.0" series from LaCie.

Memo :

Before purchasing, check the compatible devices on the LaCie website.

- LaCie
- <http://www.lacie.com/home.htm?cc=1>
- USB external hard disk drives up to 2 TB can be used.

Copying and Playback with a USB External Hard Disk Drive

- "Preparing a USB External Hard Disk Drive" (☞ p. 156)
- "Copying All Files" (☞ p. 156)
- "Playing Back Files in the USB External Hard Disk Drive" (☞ p. 157)
- "Deleting Folders in the USB External Hard Disk Drive" (☞ p. 158)

Importing Files from the USB External Hard Disk Drive

"Importing Files from the USB External Hard Disk Drive" (☞ p. 159)

Memo :

- Format the USB external hard disk drive when connecting it to this unit for the first time. (All data will be deleted.)
- "Formatting the USB External Hard Disk Drive" (☞ p. 158)
- Refer to the help file of the provided Everio MediaBrowser 4 BE software when you use the PC to operate the data in the USB external hard disk drive directly copied from this unit.
- USB external hard disk drives with the capacity over 2 TB cannot be used.
- Copying may take time. (For example, saving 1 hour video in XP mode takes about 20 minutes.)
- When there are many files to back up, it may take time for the backup to be completed. Wait for a while as the access lamp appears blinking, which indicates normal operation.
- Sound or video may be interrupted during playback.

Caution :

- Do not connect a USB hub between this unit and the USB external hard disk drive.
- Disconnect the USB external hard disk drive when using other USB devices such as DVD writer, external Blu-ray drive, or another USB external hard disk drive.
- Avoid the following operations during copying and playing back.
 - Turning off the unit or the USB external hard disk drive.
 - Disconnecting the USB cable.
- Do not format the USB external hard disk drive using the PC. If you did, format again using this unit. (All the data in the USB external hard disk drive will be erased.)
- Avoid the following operations using the PC.
 - Deleting files or folders in the USB external hard disk drive.
 - Moving files or folders in the USB external hard disk drive.
 - Changing the name of files or folders in the USB external hard disk drive.
 These operations make the data impossible to be played back on this unit.
- When you use the PC to edit the data in the USB external hard disk drive, copy the data to the PC before editing. Editing the data in the USB external hard disk drive directly from the PC makes the data impossible to be played back on this unit.

Preparing a USB External Hard Disk Drive

Memo :

- When connecting to the external hard disk drive, use a USB cable with Mini-A (Male) – B (Male) connectors. The USB cable provided with this unit cannot be used.
- To use the USB cable provided with the USB external hard disk drive, purchase the following USB conversion cable.
Part number*: QAM0852-001 Mini-A (Male) – A (Female)
*Consult your nearest service center.

- 1 Remove the AC adapter and battery pack from this unit.
- 2 Open the LCD monitor.

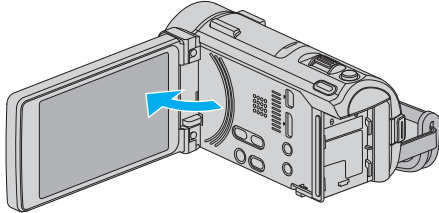

- 3 Connect the USB cable and the AC adapter.

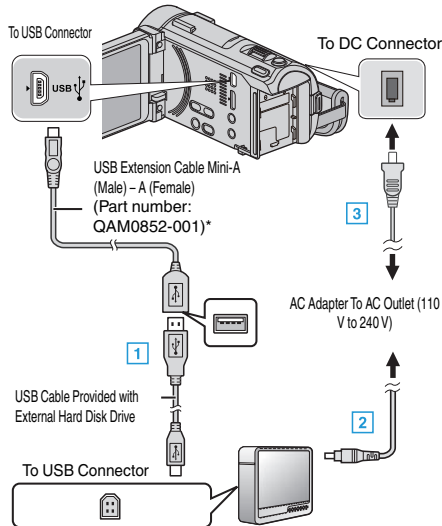

*Consult your nearest service center.

- 1 Connect the USB cable with the USB external hard disk drive.
 - 2 Connect the AC adapter of the USB external hard disk drive.
- Turn on the external hard disk drive.
 - 3 Connect the AC adapter to this unit.
 - This unit powers on automatically when the AC adapter is connected.
 - This unit turns on and the “BACK-UP” menu appears.
 - While the USB cable is connected, the “BACK-UP” menu is displayed.
 - Refer also to the instruction manual of the external hard disk drive.

Caution :

- Be sure to turn off the power when connecting the devices. Otherwise, electric shocks or malfunctions may occur.
- Do not connect a USB hub between this unit and the USB external hard disk drive.

Copying All Files

All videos or still images recorded on this unit will be copied.

You can also select and copy only the videos or still images that have never been copied.

- 1 Select video or still image mode.
- 2 Tap “BACK UP”.

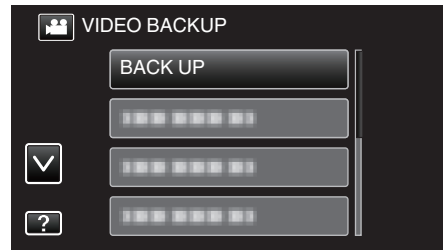

- Tap to switch between the video (60i), video (60p), and still image modes. Switch to the mode in which you want to copy files.

- 3 Tap the desired method.

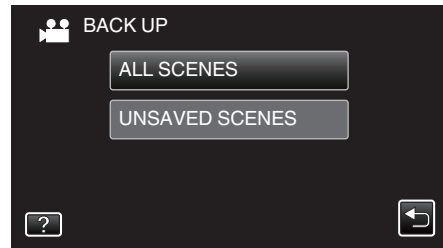

- “ALL SCENES” (video)/“ALL IMAGES” (still image):

All videos or still images in this unit are copied.

- “UNSAVED SCENES” (video)/“UNSAVED IMAGES” (still image):

Videos or still images that have never been copied are automatically selected and copied.

- 4 Check that there is sufficient remaining space on the hard disk drive and tap “YES”.

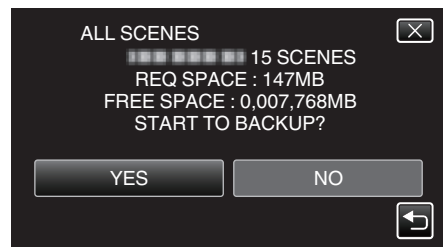

- Backup starts when “YES” is tapped.

- 5 Tap "OK" when "COMPLETED" is displayed.

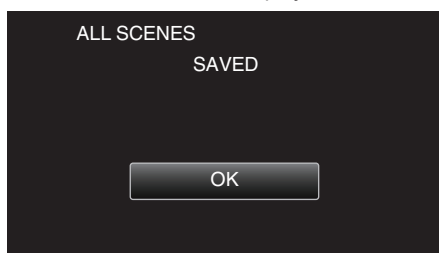

- 6 Press and hold the button for 2 seconds or more to turn off this unit and disconnect the USB cable.

Caution :

- Do not turn off the power or remove the USB cable until copying is complete.
- Files that are not on the index screen during playback cannot be copied. Special files cannot be copied either.
- If the desired video or still image is not copied, switch the mode to video (60i), video (60p), or still image accordingly in step 2.
- Copying may take time. (For example, saving 1 hour video in XP mode takes about 20 minutes.)
- In case the videos are saved, upon completion of saving, the setting for the "SYSTEM SELECT" is automatically changed to the video mode (either 60i or 60p) that is saved. Change the settings as necessary. "SYSTEM SELECT" (see p. 179)

Playing Back Files in the USB External Hard Disk Drive

Videos or still images saved in an external hard disk drive can be played back on this unit.

- 1 Tap "PLAYBACK".

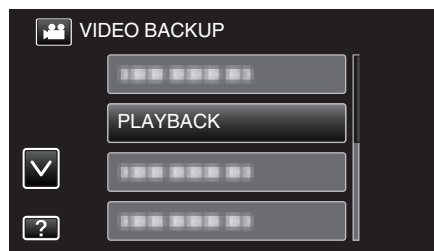

- 2 Select video (60i or 60p), or still image mode.

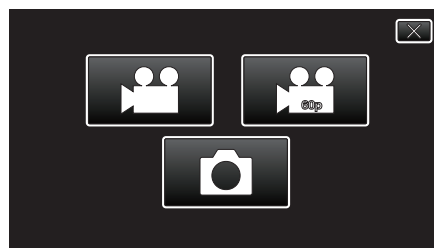

- If step 2 is not displayed, go to step 3.
- If the backup files of video (60i or 60p), or still image are not made, these icons won't be displayed.

- 3 Tap on the folder to play back.

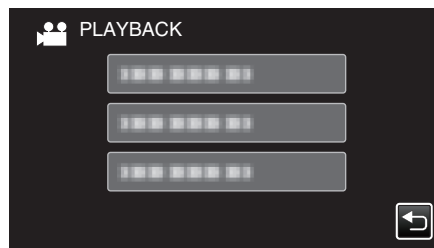

- Tap to return to the "BACK-UP" menu.

- 4 Tap on the file to play back.

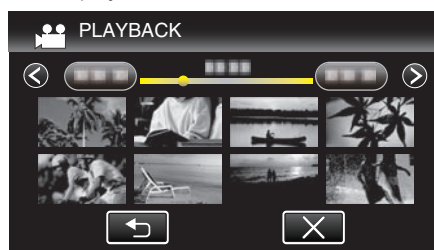

- Tap to return to the folder index screen.
- For details on video playback, refer to "Operation Buttons for Video Playback" (see p. 119).
- To exit, stop playback and turn off the camcorder by pressing the button for about 2 seconds. Then, disconnect the USB cable.

Caution :

- In case the videos are played back, upon completion of the playback, the setting for the "SYSTEM SELECT" is automatically changed to the video mode (either 60i or 60p) that is played. Change the settings as necessary. "SYSTEM SELECT" (see p. 179)

Memo :

- Sound or video may be interrupted during playback.

Deleting Folders in the USB External Hard Disk Drive

Files that are copied to the external hard disk drive can be deleted.

Caution :

- Deleted files cannot be restored.
- Be sure to back up important files on a PC.

“Backing Up All Files” (☞ p. 162)

- 1 Select video or still image mode.
- 2 Tap “DELETE”.

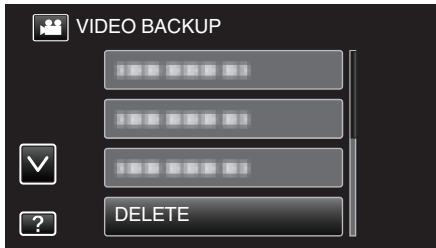

- Tap  to switch between the video (60i), video (60p), and still image modes. Switch to the mode in which you want to delete files.

- 3 Tap on the folder to delete.

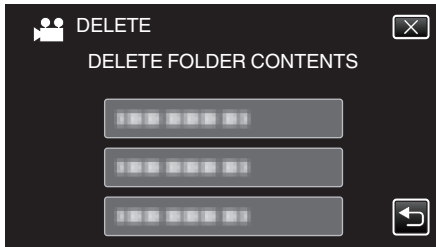

- 4 Tap “YES”.

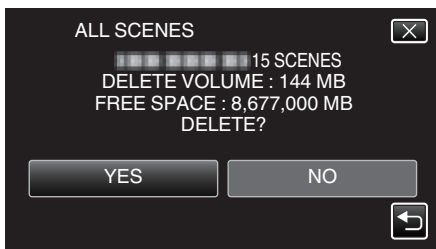

- After deleting, tap “OK”.

Caution :

- In case the videos are deleted, upon completion of deletion, the setting for the “SYSTEM SELECT” is automatically changed to the video mode (either 60i or 60p) that is deleted. Change the settings as necessary. “SYSTEM SELECT” (☞ p. 179)

Formatting the USB External Hard Disk Drive

All files on the external hard disk drive can be deleted.

Caution :

- All data on the external hard disk drive will be deleted when it is formatted. Copy all files on the external hard disk drive to a computer before formatting.

- 1 Select video or still image mode.
- 2 Tap “FORMAT”.

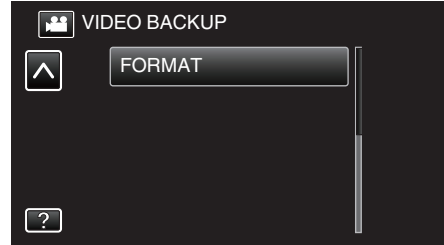

- 3 Tap “YES”.

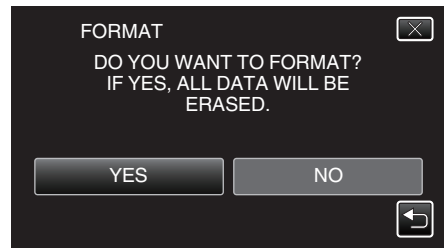

- After formatting, tap “OK”.

Importing Files from the USB External Hard Disk Drive

You can copy video files from a USB external hard disk drive to the SD card of this unit.

- 1 Select video mode.
- 2 Tap "IMPORT FROM DEVICE" in "BACK-UP".

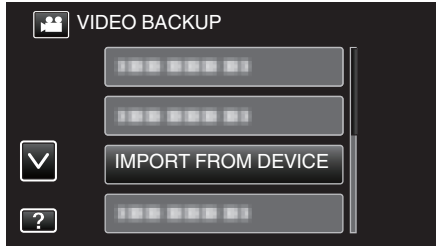

- Tap to switch between the video (60i), video (60p), and still image modes. Switch to the mode in which you want to import files.

- 3 Tap on the folder to import.

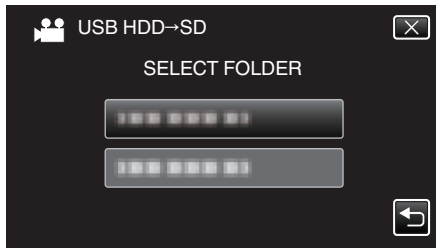

- 4 Tap on the files to import.

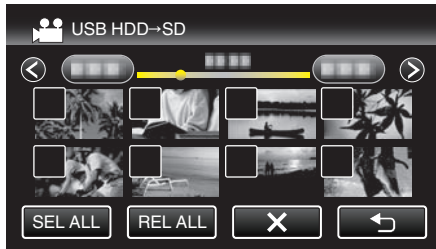

- ✓ appears on the selected files.
To remove ✓ from a file, tap on the file again.
- Tap "SEL ALL" to select all files.
- Tap "REL ALL" to release all selections.

- 5 Tap "SET".

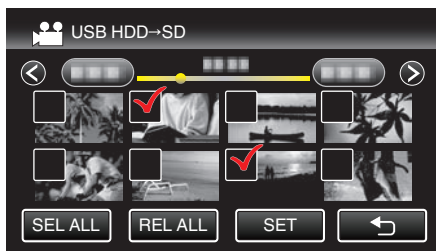

- "SET" is deactivated when no file is selected.

- 6 Tap "YES".

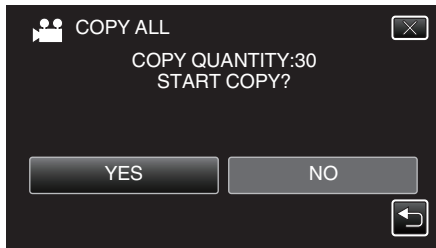

- Importing starts when "YES" is tapped.
- To cancel importing of files, tap "STOP", then tap "YES".

- 7 After importing, tap "OK".

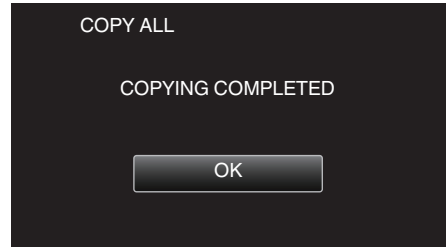

- 8 Press and hold the button for 2 seconds or more to turn off this unit and disconnect the USB cable.

Caution :

- In accordance to the imported video, settings for the "SYSTEM SELECT" is changed to video mode (60i or 60p) automatically, after the video is imported. Change the settings as necessary.
- "SYSTEM SELECT" (p. 179)

Memo :

- Files that are saved to the USB external hard disk drive from other devices cannot be copied to this unit.

Copying to Windows PC

You can copy files to a computer using the provided software.
Discs can also be created using the computer's DVD or Blu-ray drive.
If the provided software is not installed, this unit will be recognized as an external storage when connected.

Memo :

- To record to discs, a recordable DVD or Blu-ray drive is required for the computer in use.
- Still images cannot be recorded to discs using the provided software.
- To create DVD-Video discs, it is necessary to install the additional software.
For details, refer to the Pixela homepage.

<http://www.pixela.co.jp/oem/jvc/mediabrowser/e/>

- Backing up of files using other softwares is not supported.

Trouble with Using the Provided Software Everio MediaBrowser 4 BE

Consult the customer service center below.

- Pixela User Support Center

Telephone	USA and Canada (English): +1-800-458-4029 (toll-free) Europe (UK, Germany, France, and Spain) (English/German/French/Spanish): +800-1532-4865 (toll-free) Other Countries in Europe (English/German/French/Spanish): +44-1489-564-764 Asia (Philippines) (English): +63-2-438-0090 China (Chinese): 10800-163-0014 (toll-free)
Homepage	http://www.pixela.co.jp/oem/jvc/mediabrowser/e/

- For details on how to use the software, refer to "MediaBrowser Help" in the "Help" menu of Everio MediaBrowser 4 BE.

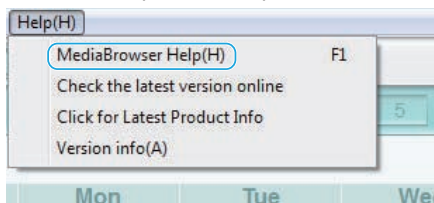

Verifying System Requirements (Guideline)

Right-click on "Computer" (or "My Computer") in the "Start" menu and select "Properties" to check the following items.

Windows Vista/Windows 7

- Refer to the operating instructions found in the animation on the Detailed User Guide.

Windows XP

- Refer to the operating instructions found in the animation on the Detailed User Guide.

	Windows Vista/Windows 7	Windows XP
OS	Windows Vista 32/64-bit Home Basic or Home Premium (Pre-installed versions only) Service Pack 2 Windows 7 32/64-bit Home Premium (Pre-installed versions only) Service Pack 1	Windows XP Home Edition or Professional (Pre-installed versions only) Service Pack 3
CPU	Intel Core Duo, CPU 1.66 GHz or higher (Intel Core 2 Duo, CPU 2.13 GHz or higher recommended)	Intel Core Duo, CPU 1.66 GHz or higher (Intel Core 2 Duo, CPU 2.13 GHz or higher recommended)
RAM	At least 2 GB	At least 1 GB
Video editing	Intel Core i7, CPU 2.53 GHz or higher recommended	Intel Core i7, CPU 2.53 GHz or higher recommended

Other requirements

Display: 1024×768 pixels or above (1280×1024 pixels or above recommended)
Graphic: Intel G965 or higher recommended

Memo :

- If your PC does not meet the above system requirements, operations of the provided software cannot be guaranteed.
- For more information, contact your PC's manufacturer.

Installing the Provided Software

You can display the recorded images in calendar format and perform simple editing using the provided software.

Windows Vista/Windows 7

- Refer to the operating instructions found in the animation on the Detailed User Guide.
-

Windows XP

- Refer to the operating instructions found in the animation on the Detailed User Guide.

Copying

Backing Up All Files

Before making backup, make sure that enough free space is left in the computer's hard disk (HDD). Backup will not start if there is not enough free space.

- 1 Remove the AC adapter and battery pack from this unit.
- 2 Open the LCD monitor.

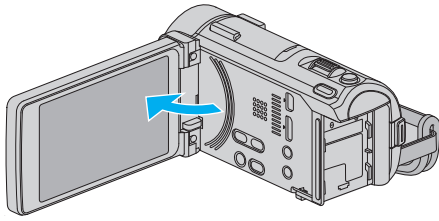

- 3 Connect the USB cable and the AC adapter.

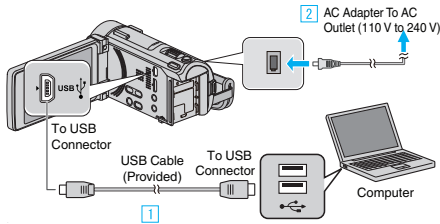

- 1 Connect using the provided USB cable.
 - 2 Connect the AC adapter to this unit.
- This unit powers on automatically when the AC adapter is connected.
 - Be sure to use the supplied AC adapter.
 - 3 The "SELECT DEVICE" menu appears.

- 4 Tap "CONNECT TO PC".

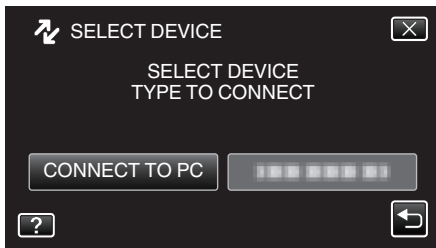

- 5 Tap "BACK UP".

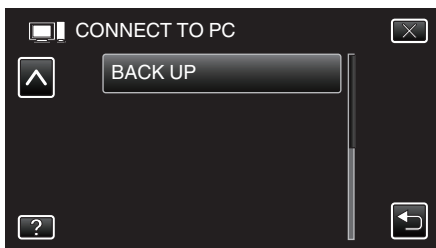

- Tap X to exit the menu.
- Tap ↶ to return to the previous screen.
- The provided software Everio MediaBrowser 4 BE starts up on the computer. The subsequent operations are to be performed on the computer.

- 6 Select the source of the image file.

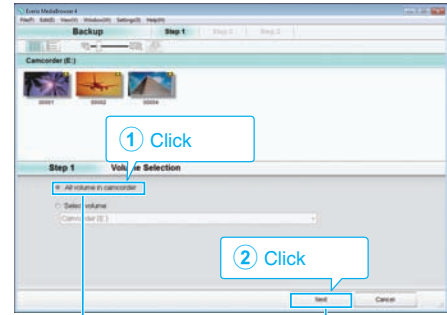

Click "All volume in camcorder"

- 7 Start backup.

Saving Destination (PC)

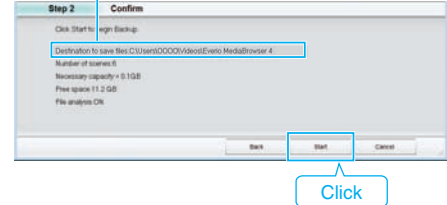

- Backup starts.

- 8 After backup is complete, click "OK".

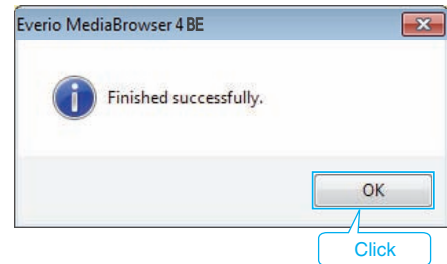

Memo :

- Before making backup, load the SD card in which the videos and still images are stored on this unit.
- If you encounter any problems with the provided software Everio MediaBrowser 4 BE, please consult the "Pixela User Support Center".

Telephone	USA and Canada (English): +1-800-458-4029 (toll-free) Europe (UK, Germany, France, and Spain) (English/German/French/Spanish): +800-1532-4865 (toll-free) Other Countries in Europe (English/German/French/Spanish): +44-1489-564-764 Asia (Philippines) (English): +63-2-438-0090 China (Chinese): 10800-163-0014 (toll-free)
Homepage	http://www.pixela.co.jp/oem/jvc/mediabrowser/e/

- Delete unwanted videos before making backup. It takes time to back up many videos.

"Deleting Unwanted Files" (p. 129)

Disconnecting this Unit from Computer

- 1 Click "Safely Remove Hardware and Eject Media".

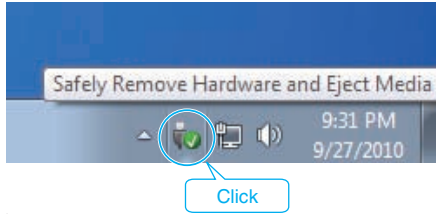

- 2 Click "Safely Remove USB Mass Storage Device".
- 3 (For Windows Vista) Click "OK".
- 4 Disconnect the USB cable and close the LCD monitor.

Organizing Files

After backing up your files, organize them by adding labels such as "Family Trip" or "Athletic Meet". This is useful not only for creating discs, but for viewing the files too.

- 1 Double-click on the Everio MediaBrowser 4 BE icon.
 - The provided software starts up.



- 2 Display the month of the files to organize.



- 3 Create a user list.

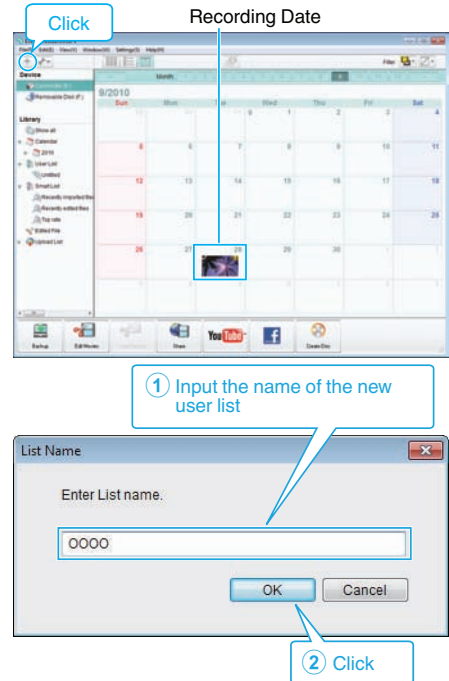

- A new user list is added to the user list library.

- 4 Click on the recording day.
 - The thumbnails of the files recorded on the day are displayed.



- 5 Register files to the created user list.

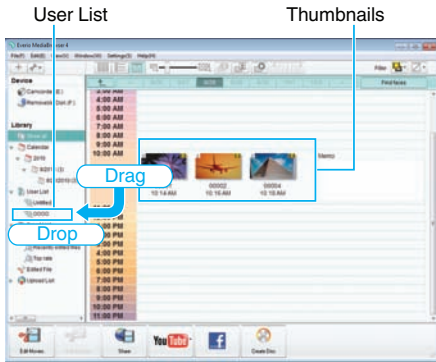

Identifying Video or Still Image :

- You can select files using the “SELECT” menu on the top right of the screen.
- Check the video/still image icon on the top right corner of the thumbnail.



Memo :

- If you encounter any problems with the provided software Everio MediaBrowser 4 BE, please consult the “Pixela User Support Center”.

Telephone	USA and Canada (English): +1-800-458-4029 (toll-free) Europe (UK, Germany, France, and Spain) (English/German/French/Spanish): +800-1532-4865 (toll-free) Other Countries in Europe (English/German/French/Spanish): +44-1489-564-764 Asia (Philippines) (English): +63-2-438-0090 China (Chinese): 10800-163-0014 (toll-free)
Homepage	http://www.pixela.co.jp/oem/jvc/mediabrowser/e/

Recording Videos to Discs

Copy the files that are arranged using the user list to discs.

- 1 Insert a new disc into the PC’s recordable DVD drive.
- 2 Select the desired user list.

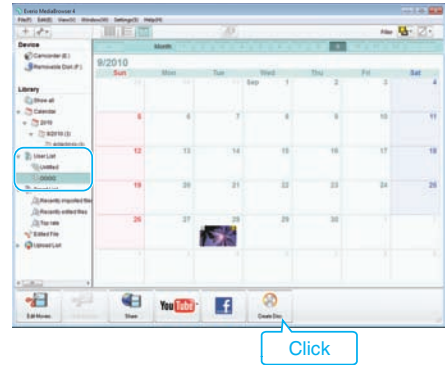

- 3 Select the disc type.

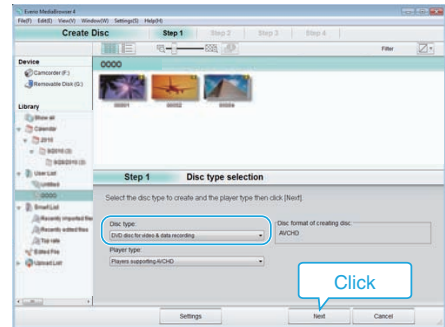

- 4 Select the files to copy to disc in order.

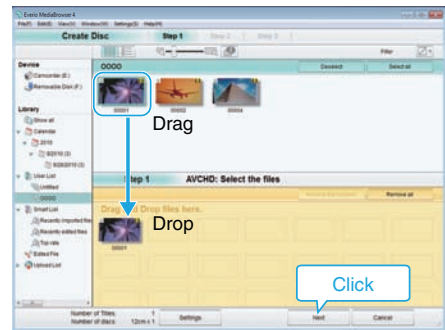

- Click “Settings” to select the disc type.
- Click “Select all” to select all the displayed files.
- After selecting, click “Next”.

- 5 Set the title of the top menu of the disc.

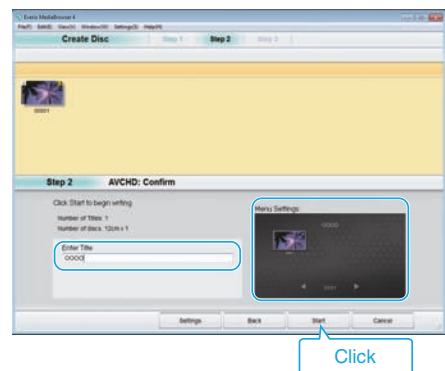

- Click “Settings” to select the menu background.
- After setting, click “Start”.

- 6 After copying is complete, click “OK”.

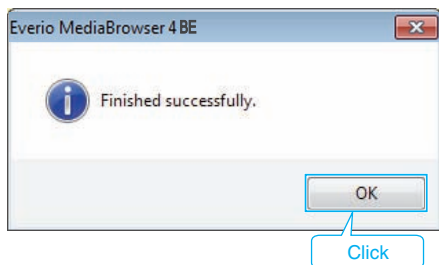

Memo : _____

- The following types of discs can be used on the provided software Everio MediaBrowser 4 BE.
 - DVD-R
 - DVD-R DL
 - DVD-RW
 - DVD+R
 - DVD+R DL
 - DVD+RW
 - BD-R
 - BD-R DL
 - BD-RE
 - BD-RE DL

- The following formats are supported by the provided software Everio MediaBrowser 4 BE.
 - Blu-ray
 - AVCHD
 - DVD-Video*

*To create DVD-Video discs, it is necessary to install the additional software. For details, refer to the Pixela homepage.

<http://www.pixela.co.jp/oem/jvc/mediabrowser/e/>

- Use Everio MediaBrowser 4 BE Player to play back a Blu-ray or AVCHD disc. Refer to the help file of the provided Everio MediaBrowser 4 BE software to operate.
- When copying videos recorded in UXP recording mode to create an AVCHD disc, the videos need to be converted to XP recording mode before copying. Therefore, it may take a longer time than copying videos recorded in other modes.
- Videos recorded in the UXP or AVCHD Progressive mode can only be created into a disc in the Blu-ray format.
- To view the help file of Everio MediaBrowser 4 BE, select "Help" from the Everio MediaBrowser 4 BE's menu bar or press F1 on the keyboard.
- If you encounter any problems with the provided software Everio MediaBrowser 4 BE, please consult the "Pixela User Support Center".

Telephone	USA and Canada (English): +1-800-458-4029 (toll-free) Europe (UK, Germany, France, and Spain) (English/German/French/Spanish): +800-1532-4865 (toll-free) Other Countries in Europe (English/German/French/Spanish): +44-1489-564-764 Asia (Philippines) (English): +63-2-438-0090 China (Chinese): 10800-163-0014 (toll-free)
Homepage	http://www.pixela.co.jp/oem/jvc/mediabrowser/e/

Copying

Backing Up Files Without Using Provided Software

Copy the files to a computer using the following method.

- 1 Remove the AC adapter and battery pack from this unit.
- 2 Open the LCD monitor.

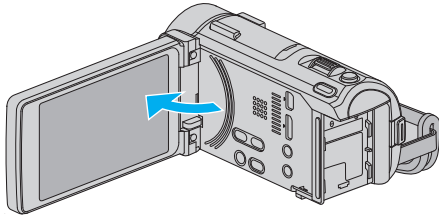

- 3 Connect the USB cable and the AC adapter.

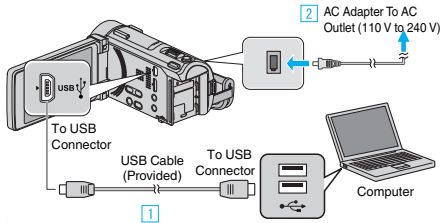

- 1 Connect using the provided USB cable.
 - 2 Connect the AC adapter to this unit.
- This unit powers on automatically when the AC adapter is connected.
 - Be sure to use the supplied AC adapter.
- 3 The "SELECT DEVICE" menu appears.
- 4 Tap "CONNECT TO PC".

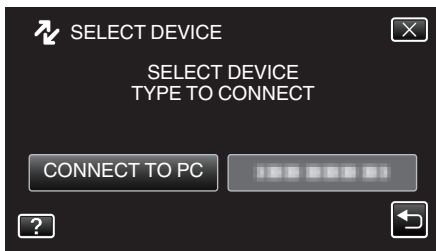

- 5 Tap "PLAYBACK ON PC".

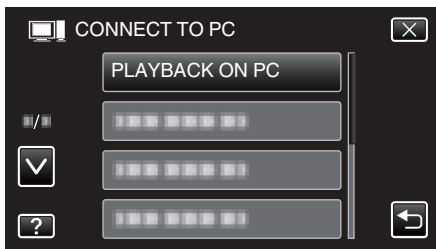

- Tap X to exit the menu.
 - Tap ↶ to return to the previous screen.
 - Close the Everio MediaBrowser 4 BE program, if it starts.
 - Operations are to be performed on the computer after the screen switches.
- 6 Select "Computer" (Windows Vista) / "My Computer" (Windows XP) / "Computer" (Windows 7) from the "Start" menu, then click on the "JVCCAM_SD" icon.
 - Open the folder with the desired files.
 - "List of Files and Folders" (p. 167)
 - 7 Copy the files to any folder in the computer (desktop, etc).

Caution :

- When the folders or files are deleted/moved/renamed in the computer, they cannot be played back on this unit anymore.

Memo :

- To edit/view the files, use a software that supports AVCHD (video)/JPEG (still image) files.
- The above operations on computer may vary with the system used.

Disconnecting this Unit from Computer

- 1 Click "Safely Remove Hardware and Eject Media".

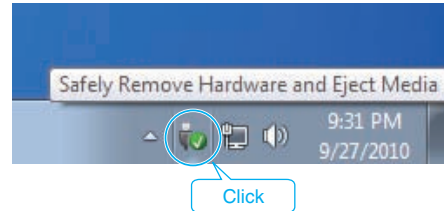

- 2 Click "Safely Remove USB Mass Storage Device".
- 3 (For Windows Vista) Click "OK".
- 4 Disconnect the USB cable and close the LCD monitor.

List of Files and Folders

Folders and files are created in the SD card as shown below.
They are created only when necessary.

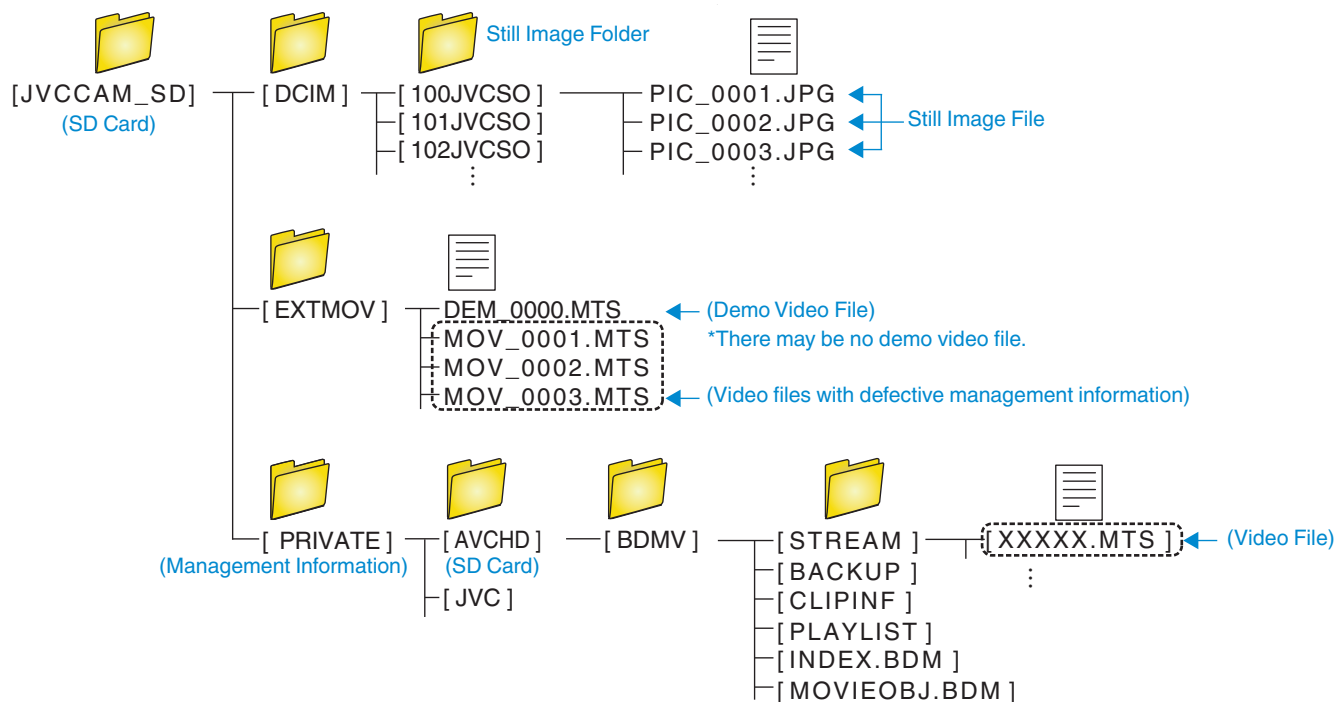

Caution :

- When the folders or files are deleted/moved/rename in the computer, they cannot be played back on this unit anymore.

Copying to Mac Computer

Copy the files to a Mac computer using the following method.

- 1 Remove the AC adapter and battery pack from this unit.
- 2 Open the LCD monitor.

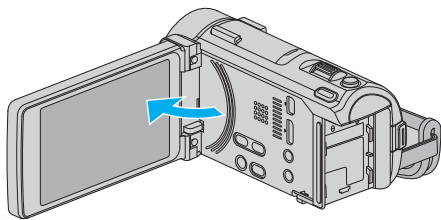

- 3 Connect the USB cable and the AC adapter.

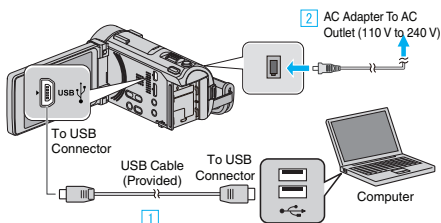

- 1 Connect using the provided USB cable.
 - 2 Connect the AC adapter to this unit.
- This unit powers on automatically when the AC adapter is connected.
 - Be sure to use the supplied AC adapter.
 - 3 The “SELECT DEVICE” menu appears.
- 4 Tap “CONNECT TO PC”.

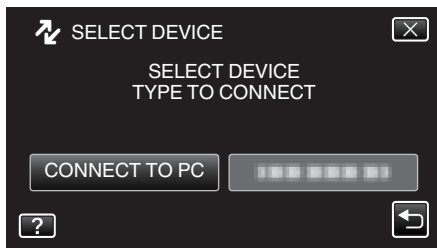

- 5 Tap “PLAYBACK ON PC”.

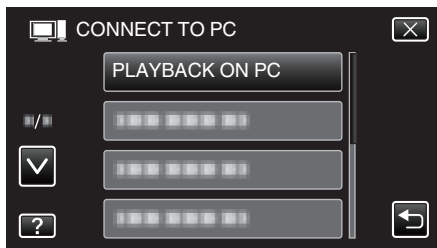

- Tap X to exit the menu.
- Tap ↶ to return to the previous screen.
- The “JVCCAM_SD” icon appears on the desktop.

- 6 Start iMovie.
 - The subsequent operations are to be performed on the Mac computer.

Caution :

- When the folders or files are deleted/moved/renamed in the computer, they cannot be played back on this unit anymore.
- MTS files that are copied to a Mac computer cannot be imported to iMovie. To use MTS files with iMovie, import the files using iMovie.
- Videos recorded in the 60p mode (when “SYSTEM SELECT” is set to “60p”) are not supported.

Memo :

- To edit/view the files, use a software that supports AVCHD (video)/JPEG (still image) files.
- When removing this unit from the computer, drag and drop the “JVCCAM_SD” icon on the desktop to the trash bin.

iMovie and iPhoto

You can import files from this unit to a computer using Apple’s iMovie ’08, ’09, ’11 (video) or iPhoto (still image). To verify the system requirements, select “About This Mac” from the Apple menu. You can determine the operating system version, processor and amount of memory.

- For the latest information on iMovie or iPhoto, refer to the Apple website.
- For details on how to use iMovie or iPhoto, refer to the help file of the respective softwares.
- There is no guarantee that the operations will work with all computer environments.

Operating the Menu

There are three types of menus in this unit.

- Shortcut menu - Menu that contains the recommended functions from the video/still image main menu.
- Main menu - Menu that contains all the items specific to the video recording, still image recording, video playback, and still image playback modes respectively.
- ⚙️ (“COMMON”) menu in the main menu - Menu that contains all common items in the video recording, still image recording, video playback, and still image playback modes.

Operating the Shortcut Menu

You can configure various settings of the recommended functions in the video/still image recording mode using the shortcut menu.

- 1 Tap “MENU”.

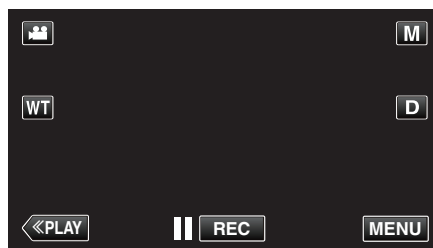

- The shortcut menu appears.

- 2 Tap the desired menu and setting.

<Shortcut Menu During Video Recording Mode>

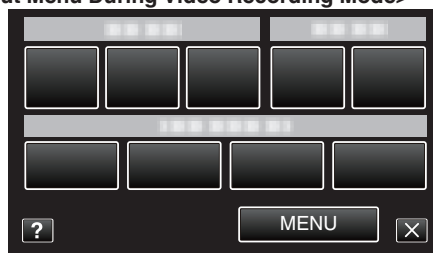

“Wi-Fi Capabilities” (☰ p. 12)

“Image Monitoring via Direct Connection (DIRECT MONITORING)” (☰ p. 14)

“Record and Send Videos via E-mail (VIDEO MAIL ATTN.)” (☰ p. 25)

- SMILE: Allows settings of “SMILE SHOT” and “SMILE%/NAME DISPLAY”.
- EFFECT RECORDING: Allows settings of “ANIMATION EFFECT”, “DECORATE FACE EFFECT”, “HANDWRITING EFFECT” and “STAMP”.
- MENU: Allows settings of other menus.

<Shortcut Menu During Still Image Recording Mode>

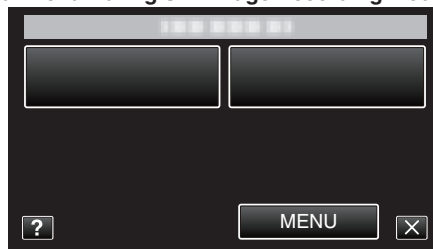

- SMILE: Allows settings of “SMILE SHOT” and “SMILE%/NAME DISPLAY”.
- MENU: Allows settings of other menus.

Memo :

- To exit the screen
Tap “X” (quit).
- To display the help file
Tap “?” (help) and tap the item.

Menu Settings

Operating the Main Menu

You can configure various settings using the menu.

1 Tap "MENU".

- The menu differs according to the mode in use.

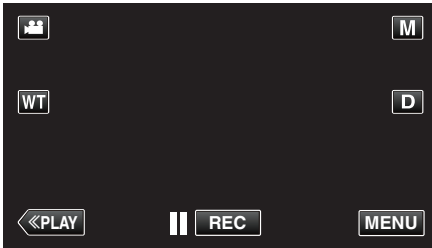

- When entering from the recording mode, tap "MENU" again as the shortcut menu appears.

2 Tap the desired menu.

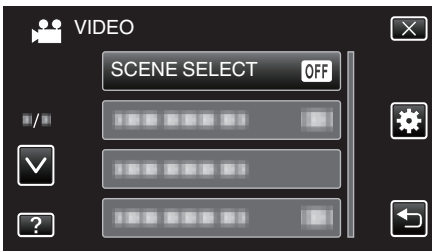

3 Tap the desired setting.

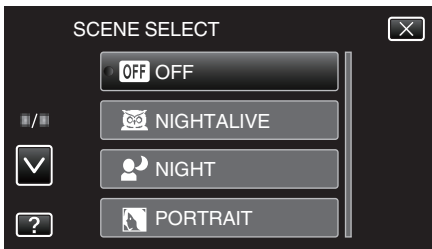

Memo :

- To display the previous/next menu
Tap "▲" or "▼".
- To exit the screen
Tap "X" (quit).
- To return to the previous screen
Tap "↶" (return).
- To display the help file
Tap "?" (help) and tap the item.
Help file may not be available for some items.

Operating the Common Menu

You can configure common setting items regardless of the mode using the common menu.

1 Tap "MENU".

- The menu differs according to the mode in use.

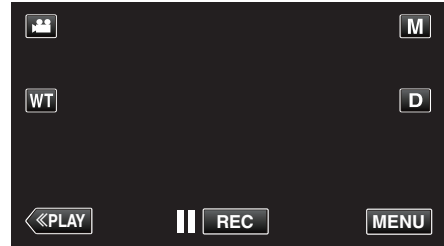

- When entering from the recording mode, tap "MENU" again as the shortcut menu appears.

2 Tap "⚙️".



3 Tap the desired setting.

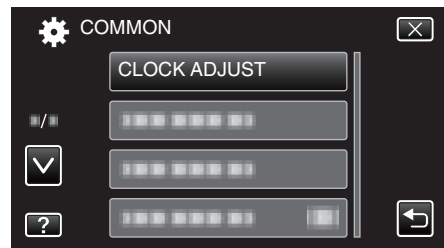

Memo :

- To display the previous/next menu
Tap "▲" or "▼".
- To exit the screen
Tap "X" (quit).
- To return to the previous screen
Tap "↶" (return).
- To display the help file
Tap "?" (help) and tap the item.
Help file may not be available for some items.

Recording Menu (Video)

You can adjust various settings, such as brightness and white balance, to suit the subject or purpose. You can also change settings such as picture quality and gain.

- 1 Open the LCD monitor.

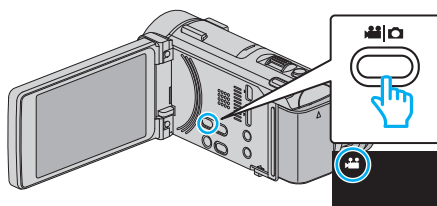

- Check if the recording mode is .

- 2 Tap "MENU".

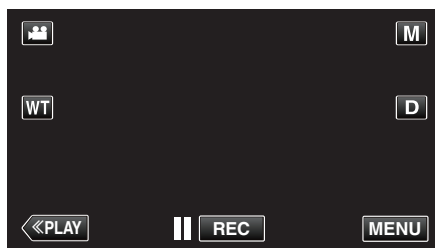

- The shortcut menu appears.

- 3 Tap "MENU" in the shortcut menu.

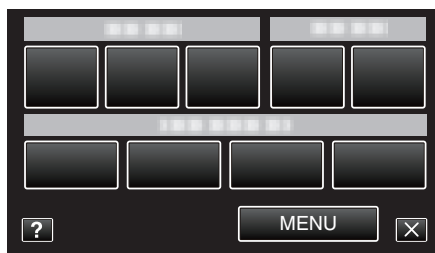

Setting	Details
INFO.	You can check the remaining recording time on the SD card. "Checking the Remaining Recording Time" (☞ p. 117)
SCENE SELECT	Settings to suit the shooting condition can be selected. "Shooting According to Scene (Subject)" (☞ p. 84) *Displayed only in the manual recording mode.
FOCUS	Focus can be adjusted manually. "Adjusting Focus Manually" (☞ p. 86) *Displayed only in the manual recording mode.
BRIGHTNESS ADJUST	Adjusts the overall brightness of the screen. "Adjusting Brightness" (☞ p. 87) *Displayed only in the manual recording mode.
SHUTTER SPEED	Shutter speed can be adjusted. "Setting Shutter Speed" (☞ p. 88) *Displayed only in the manual recording mode.
APERTURE PRIORITY	Adjusts the aperture value. "Setting Aperture" (☞ p. 89) *Displayed only in the manual recording mode.
WHITE BALANCE	Adjusts the color according to the light source. "Setting White Balance" (☞ p. 90) *Displayed only in the manual recording mode.
BACKLIGHT COMP.	Corrects the image when the subject appears dark due to backlight. "Setting Backlight Compensation" (☞ p. 91) *Displayed only in the manual recording mode.
ZEBRA	During video recording, diagonal lines (zebra pattern) are displayed only at areas with the specified luminance levels. "Checking for Overexposed Areas (ZEBRA)" (☞ p. 92) *Displayed only in the manual recording mode.

Menu Settings

Setting	Details
TELE MACRO	Enables close-up shots when using the telephoto (T) end of the zoom. “Taking Close-up Shots” (☞ p. 93) *Displayed only in the manual recording mode.
TOUCH PRIORITY AE/AF	Automatically adjusts focus and brightness based on the subjects' faces or selected area. “Capturing Subjects Clearly (TOUCH PRIORITY AE/AF)” (☞ p. 99)
LIGHT	Turns on/off the light. “LIGHT” (☞ p. 175)
GAIN UP	Makes the subject appear bright automatically when recording in dark places. “GAIN UP” (☞ p. 175)
WIND CUT	Reduces the noise caused by wind. “WIND CUT” (☞ p. 176)
GRID	Displays gridlines to make it easier to detect when the subject appears slanted. “GRID” (☞ p. 176)
ANIMATION EFFECT	Records videos with animation effects. “Recording with Animation Effects” (☞ p. 94)
DECORATE FACE EFFECT	Detects faces and enables decorations such as sunglasses to be added. “Recording with Face Decorations” (☞ p. 96)
STAMP	Records videos with various decorative stamps. “Recording with Decorative Stamps” (☞ p. 96)
HANDWRITING EFFECT	Records videos with your personal handwriting or drawing. “Recording with Personal Handwriting” (☞ p. 97)
HIGH SPEED RECORDING	You can record videos in slow-motion by increasing the recording speed to emphasize the movements, and play back the slow-motion video smoothly. “Slow-motion (High-speed) Recording” (☞ p. 110)
TIME-LAPSE RECORDING	Enables the changes of a scene that occur slowly over a long period to be shown within a short time by taking frames of it at a certain interval. “Recording at Intervals (TIME-LAPSE RECORDING)” (☞ p. 111)
AUTO REC	This function enables the unit to record automatically by sensing the changes in subject's movement (brightness) within the red frame displayed on the LCD monitor. “Recording Automatically by Sensing Movements (AUTO REC)” (☞ p. 113)
Wi-Fi	Sets or uses the Wi-Fi function. “Wi-Fi Capabilities” (☞ p. 12)
DATE/TIME RECORDING	You can record videos together with the date and time. Set this when you want to save the file with date and time display. (The date and time cannot be deleted after recording.) “Recording Videos with Date and Time” (☞ p. 116)
FACE SUB-WINDOW	Magnifies and displays a registered face in a sub-window. “Recording while Displaying a Magnified View of a Selected Face (FACE SUB-WINDOW)” (☞ p. 103)
SHUTTER MODE	Continuous shooting settings can be adjusted. “SHUTTER MODE” (☞ p. 177)
CONT. SHOOTING SPEED	Sets the speed for continuous shooting. “CONT. SHOOTING SPEED” (☞ p. 178)
SMILE SHOT	Automatically captures a still image upon detection of a smile. “Capturing Smiles Automatically (SMILE SHOT)” (☞ p. 100)
SMILE%/NAME DISPLAY	Sets the items to display when faces are detected. “Setting SMILE%/NAME DISPLAY” (☞ p. 107)
FACE REGISTRATION	Registers the faces of people who are often shot with this unit. “Registering Human Face Personal Authentication Information” (☞ p. 105)
PET SHOT	Automatically captures a still image upon detection of the face of a pet, such as dogs or cats. “Capturing Pets Automatically (PET SHOT)” (☞ p. 102)
SYSTEM SELECT	Sets whether to perform progressive recording of videos. “SYSTEM SELECT” (☞ p. 179)

Setting	Details
VIDEO QUALITY	Sets the video quality. “ VIDEO QUALITY ” (p. 179)
ZOOM	Sets the maximum zoom ratio. “ ZOOM ” (p. 180)
x.v.Color	Captures the true colors. (Use an x.v.Color compatible TV for playback.) “ x.v.Color ” (p. 180)
ZOOM MIC	Sets the zoom microphone. “ ZOOM MIC ” (p. 181)
MIC LEVEL	Make the adjustments such that “MIC LEVEL” does not turn red. “ MIC LEVEL ” (p. 181)
MIC LEVEL SETTING	Sets the microphone level. “ MIC LEVEL SETTING ” (p. 182)
HEADPHONE VOL. ADJ.	Sets the volume level of the connected headphones. “ HEADPHONE VOL. ADJ. ” (p. 182)

Menu Settings

INFO.

You can check the remaining recording time on the SD card as well as the remaining battery power.

Operating Details

“Checking the Remaining Recording Time” (☞ p. 117)

SCENE SELECT

Settings to suit the shooting condition can be selected.

Operating Details

“Shooting According to Scene (Subject)” (☞ p. 84)

FOCUS

Focus can be adjusted manually.

Operating Details

“Adjusting Focus Manually” (☞ p. 86)

BRIGHTNESS ADJUST

Adjusts the overall brightness of the screen.

Operating Details

“Adjusting Brightness” (☞ p. 87)

SHUTTER SPEED

Shutter speed can be adjusted.

Operating Details

“Setting Shutter Speed” (☞ p. 88)

APERTURE PRIORITY

Adjusts the aperture value.

Operating Details

“Setting Aperture” (☞ p. 89)

WHITE BALANCE

Adjusts the color according to the light source.

Operating Details

“Setting White Balance” (☞ p. 90)

BACKLIGHT COMP.

Corrects the image when the subject appears dark due to backlight.

Operating Details

“Setting Backlight Compensation” (☞ p. 91)

ZEBRA

During video recording, diagonal lines (zebra pattern) are displayed only at areas with the specified luminance levels.

Operating Details

“Checking for Overexposed Areas (ZEBRA)” (☞ p. 92)

TELE MACRO

Enables close-up shots when using the telephoto (T) end of the zoom.

Operating Details

“Taking Close-up Shots” (☞ p. 93)

TOUCH PRIORITY AE/AF

Automatically adjusts focus and brightness based on the subjects' faces or selected area.

Operating Details

“Capturing Subjects Clearly (TOUCH PRIORITY AE/AF)” (☞ p. 99)

LIGHT

Turns on/off the light.

Setting	Details
OFF	Does not light up.
AUTO	Lights up automatically when the surrounding is dark.
ON	Lights up at all times.

Displaying the Item

- 1 Open the LCD monitor.

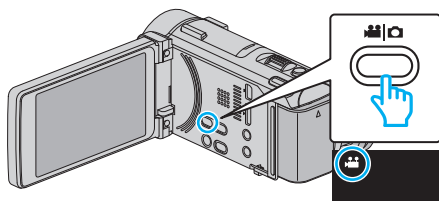

- Check if the recording mode is .

- 2 Tap "MENU".

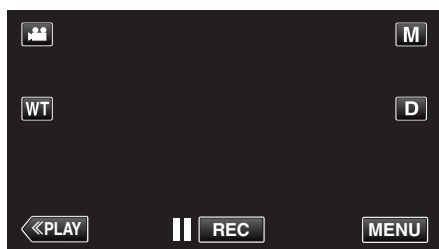

- The shortcut menu appears.

- 3 Tap "MENU" in the shortcut menu.

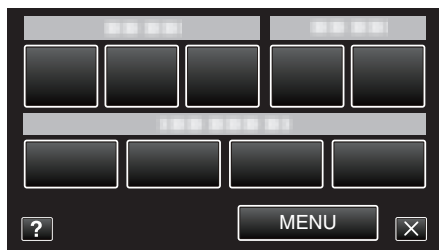

- 4 Tap "LIGHT".

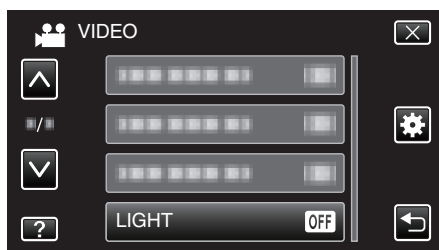

GAIN UP

Makes the subject appear bright automatically when recording in dark places.

Setting	Details
OFF	Deactivates the function.
ON	Electrically brightens the scene when it is dark.
AUTO SLOW-SHUTTER	Slows down the shutter speed to brighten the scene when it is dark.

Memo :

- Although "AUTO SLOW-SHUTTER" brightens the scene more than "ON", movements of the subject may become unnatural.

Displaying the Item

- 1 Open the LCD monitor.

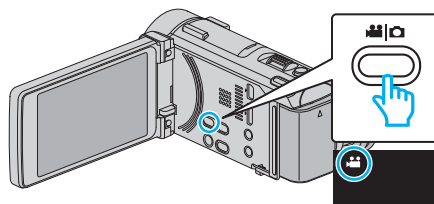

- Check if the recording mode is .

- 2 Tap "MENU".

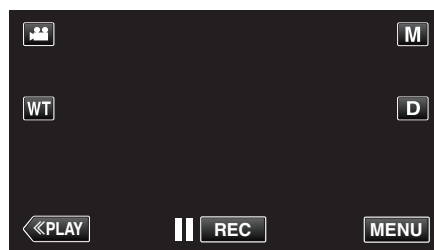

- The shortcut menu appears.

- 3 Tap "MENU" in the shortcut menu.

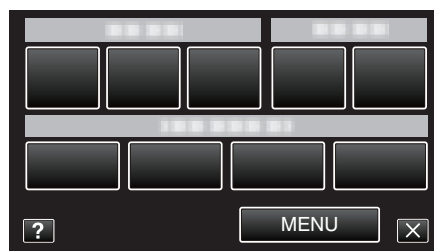

- 4 Tap "GAIN UP".

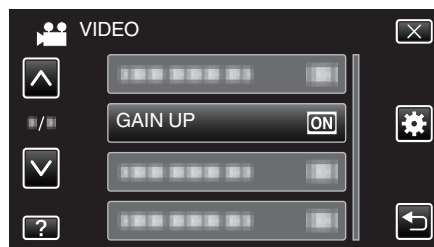

Menu Settings

WIND CUT

Reduces the noise caused by wind.

Setting	Details
OFF	Deactivates the function.
ON	Activates the function.

Displaying the Item

- 1 Open the LCD monitor.

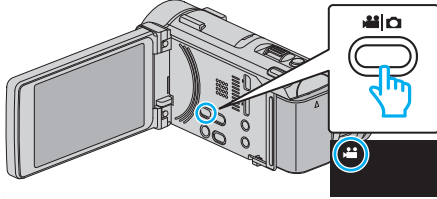

- Check if the recording mode is .

- 2 Tap "MENU".

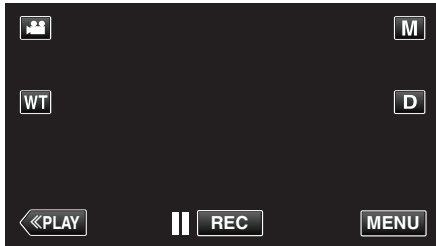

- The shortcut menu appears.

- 3 Tap "MENU" in the shortcut menu.

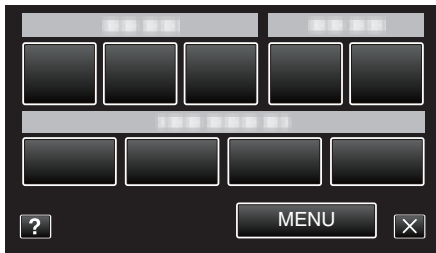

- 4 Tap "WIND CUT".

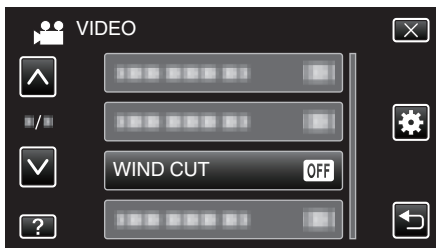

GRID

Displays gridlines to make it easier to detect when the subject appears slanted.

Setting	Details
OFF	Turns off grid display.
ON	Turns on grid display.

Displaying the Item

- 1 Open the LCD monitor.

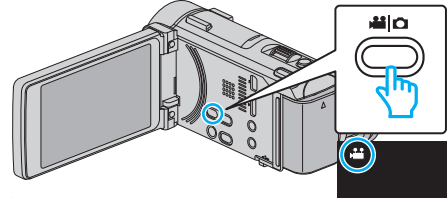

- Check if the recording mode is .

- 2 Tap "MENU".

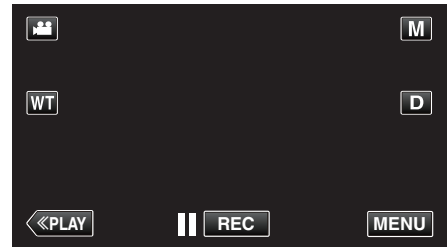

- The shortcut menu appears.

- 3 Tap "MENU" in the shortcut menu.

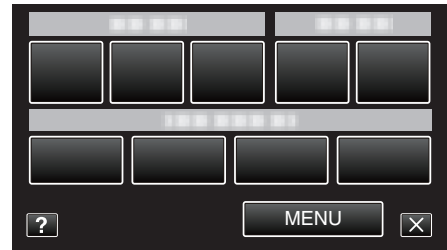

- 4 Tap "GRID".

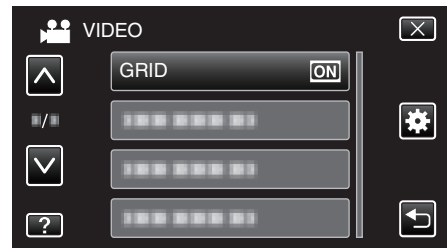

ANIMATION EFFECT

Records videos with animation effects.

Operating Details

“Recording with Animation Effects” (☞ p. 94)

DECORATE FACE EFFECT

Detects faces and enables decorations such as sunglasses to be added.

Operating Details

“Recording with Face Decorations” (☞ p. 96)

STAMP

Records videos with various decorative stamps.

Operating Details

“Recording with Decorative Stamps” (☞ p. 96)

HANDWRITING EFFECT

Records videos with your personal handwriting or drawing.

If the writings and drawings appear to be misaligned, correct the touch position.

Operating Details

“Recording with Personal Handwriting” (☞ p. 97)

HIGH SPEED RECORDING

You can record videos in slow-motion by increasing the recording speed to emphasize the movements, and play back the slow-motion video smoothly. This is a handy function for checking movements, such as golf swings.

Operating Details

“Slow-motion (High-speed) Recording” (☞ p. 110)

TIME-LAPSE RECORDING

Enables the changes of a scene that occur slowly over a long period to be shown within a short time by taking frames of it at a certain interval.

This is useful for making observations such as the opening of a flower bud.

Operating Details

“Recording at Intervals (TIME-LAPSE RECORDING)” (☞ p. 111)

AUTO REC

Starts recording automatically by sensing the changes in subject's movement (brightness) within the red frame displayed on the LCD monitor.

Operating Details

“Recording Automatically by Sensing Movements (AUTO REC)”

(☞ p. 113)

Wi-Fi

Sets or uses the Wi-Fi function.

Operating Details

“Wi-Fi Capabilities” (☞ p. 12)

DATE/TIME RECORDING

You can record videos together with the date and time.

Set this when you want to save the file with date and time display.

(The date and time cannot be deleted after recording.)

Operating Details

“Recording Videos with Date and Time” (☞ p. 116)

FACE SUB-WINDOW

Magnifies and displays a registered face in a sub-window.

Operating Details

“Recording while Displaying a Magnified View of a Selected Face (FACE SUB-WINDOW)” (☞ p. 103)

SHUTTER MODE

Continuous shooting settings can be adjusted.

Setting	Details
RECORD ONE SHOT	Records one still image.
CONTINUOUS SHOOTING	Records still images continuously while the SNAPSHOT button is pressed.

Memo :

- The continuous shooting speed can be changed. “CONT. SHOOTING SPEED” (☞ p. 178)
- “LOW SPEED” is set in the video mode.
- The size of the still image that is captured in the video mode is 1,920 x 1,080.
- Some SD cards may not support continuous shooting.
- The continuous shooting speed will drop if this function is used repeatedly.

Displaying the Item

- 1 Open the LCD monitor.

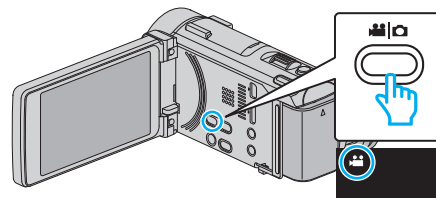

- Check if the recording mode is .

- 2 Tap “MENU”.

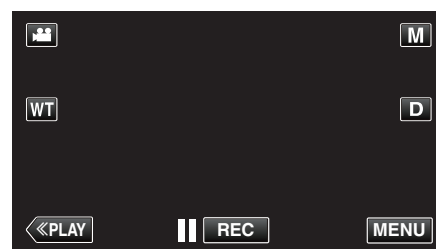

- The shortcut menu appears.

- 3 Tap “MENU” in the shortcut menu.

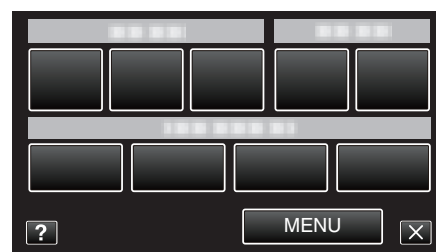

- 4 Tap “SHUTTER MODE”.

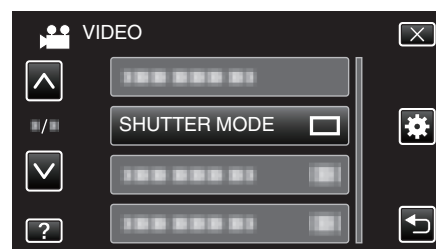

CONT. SHOOTING SPEED

Sets the speed for continuous shooting.

Setting	Details
HIGH SPEED	<ul style="list-style-type: none"> Shoots up to 95 still images continuously in the still image mode in about 6.3 second. Shoots up to 90 still images continuously in the video mode in about 1.5 second.
MEDIUM SPEED	<ul style="list-style-type: none"> Shoots up to 95 still images continuously in the still image mode in about 12.6 second. Shoots up to 90 still images continuously in the video mode in about 9 second.
LOW SPEED	Shoots continuously until the recording media is full.

Memo :

- Shooting speed slows down gradually as continuous shooting goes on in the "LOW SPEED" mode.
- Performing continuous shooting while video recording is in progress sets the mode to "LOW SPEED" temporarily.

Displaying the Item

- Open the LCD monitor.

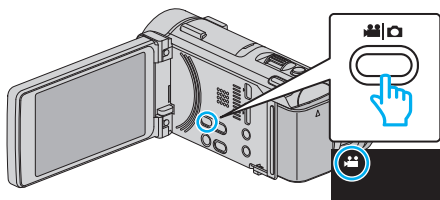

- Check if the recording mode is .

- Tap "MENU".

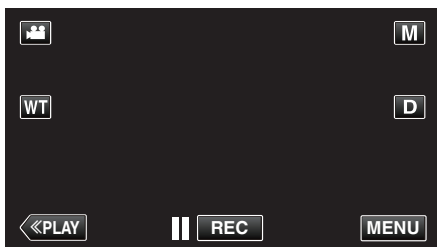

- The shortcut menu appears.

- Tap "MENU" in the shortcut menu.

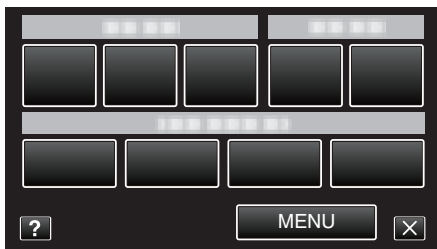

- Tap "CONT. SHOOTING SPEED".

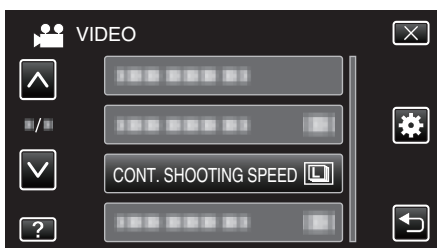

SMILE SHOT

Automatically captures a still image upon detection of a smile.

Operating Details

"Capturing Smiles Automatically (SMILE SHOT)" (p. 100)

SMILE%/NAME DISPLAY

Sets the items to display when faces are detected.

Operating Details

"Setting SMILE%/NAME DISPLAY" (p. 107)

FACE REGISTRATION

Registers the faces of people who are often shot with this unit.

Operating Details

"Registering Human Face Personal Authentication Information" (p. 105)

PET SHOT

Automatically captures a still image upon detection of the face of a pet, such as dogs or cats.

Operating Details

"Capturing Pets Automatically (PET SHOT)" (p. 102)

SYSTEM SELECT

Sets whether to perform progressive recording of videos. When progressive recording is set, high quality images with a smooth depth of field can be recorded. In addition, fast-moving subjects can also be captured sharply without flickering.

Setting	Details
60i	Does not perform progressive recording. Videos are recorded in 1080/60i.
60p	Performs progressive recording. Videos are recorded in 1080/60p.

Memo :

- Video quality cannot be set in the 60p mode.
- High-speed recording is not available in the 60p mode.
- Videos that are recorded in the 60p mode are playable only on AVCHD Progressive compatible devices.
- Videos that are recorded in the 60p mode can only be copied to Blu-ray discs. (cannot be copied to DVDs)
- Blu-ray discs containing videos that are recorded in the 60p mode are playable only on AVCHD Progressive compatible devices.
- Wi-Fi feature is not available in the 60p mode.

Displaying the Item

1 Open the LCD monitor.

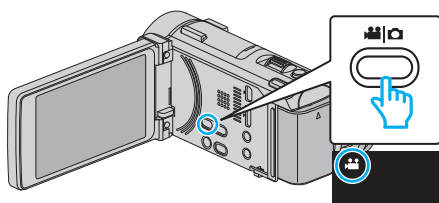

- Check if the recording mode is

2 Tap "MENU".

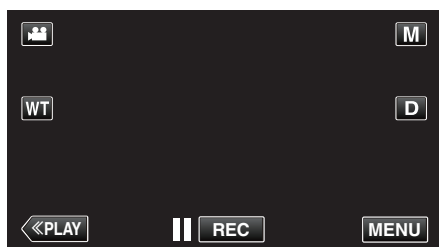

- The shortcut menu appears.

3 Tap "MENU" in the shortcut menu.

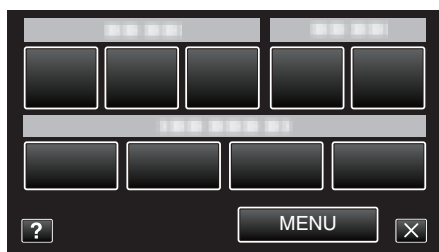

4 Tap "SYSTEM SELECT".

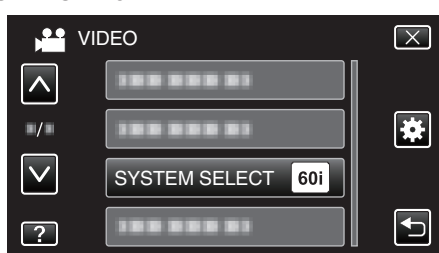

VIDEO QUALITY

Sets the video quality.

Setting	Details
UXP	Enables recording in the best picture quality. <ul style="list-style-type: none"> • Applies to Blu-ray discs only. Videos taken in high-definition quality cannot be saved to DVDs.
XP	Enables recording in high picture quality.
SP	Enables recording in standard quality.
EP	Enables long recordings.

Memo :

- Set to "UXP" or "XP" mode when recording fast-moving scenes or scenes with extreme changes of brightness to avoid noise.
- Use an BD writer (external Blu-ray drive) to save videos recorded in "UXP" mode.
- You can change to the desired "VIDEO QUALITY" by tapping on it from the remaining recording time display.
- Video quality cannot be set in the 60p mode.

Displaying the Item

1 Open the LCD monitor.

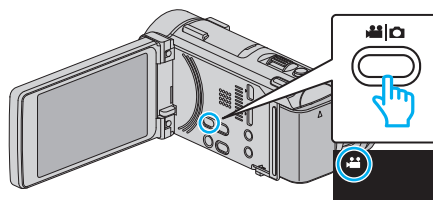

- Check if the recording mode is

2 Tap "MENU".

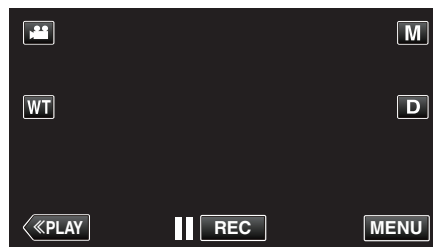

- The shortcut menu appears.

3 Tap "MENU" in the shortcut menu.

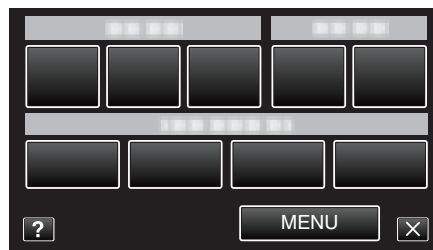

4 Tap "VIDEO QUALITY".

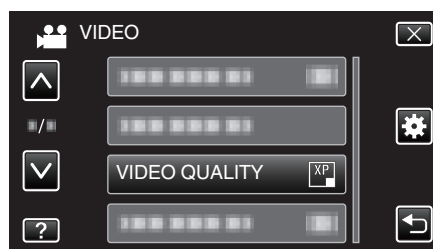

Menu Settings

ZOOM

Sets the maximum zoom ratio.

Setting	Details
10x/OPTICAL	Enables recording with 1 - 10x optical zoom. Set this when digital zoom is not desired.
15(13)x/DYNAMIC	Zoom ratio varies according to the image stabilizer setting. OFF: Up to 15x ON: Up to 13x ON (AIS): Up to 12x ON (Enhanced AIS): Up to 10x
60x/DIGITAL	Enables recording with 1 - 10x optical zoom and 11 - 60x digital zoom.
200x/DIGITAL	Enables recording with 1 - 10x optical zoom and 11 - 200x digital zoom.

Memo :

- When digital zoom is used, the image becomes grainy as it is digitally enlarged.
- The angle of view changes when the image stabilizer is turned on or off.
- Dynamic zoom is not available in the enhanced AIS mode.

Displaying the Item

- 1 Open the LCD monitor.

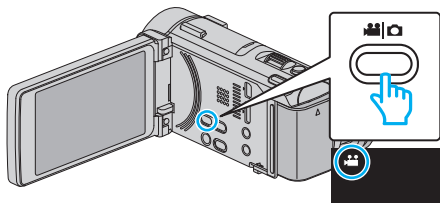

- Check if the recording mode is

- 2 Tap "MENU".

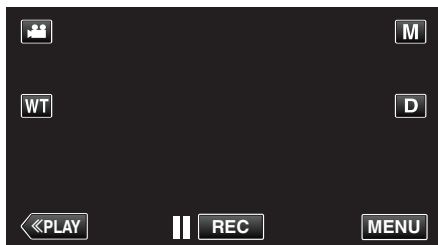

- The shortcut menu appears.

- 3 Tap "MENU" in the shortcut menu.

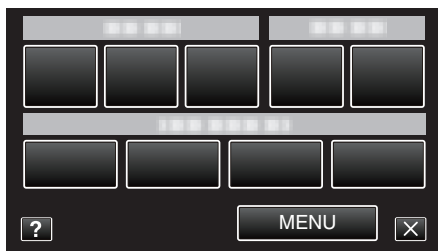

- 4 Tap "ZOOM".

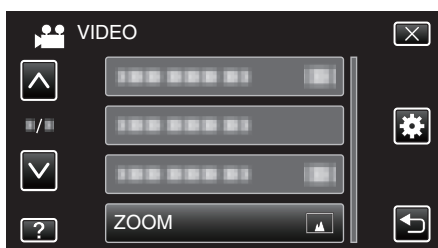

x.v.Color

Captures the true colors.

(Use an x.v.Color compatible TV for playback.)

Setting	Details
OFF	Captures colors with the same standard as TV broadcasting.
ON	Captures the true colors. (for TVs that supports x.v.Color)

Displaying the Item

- 1 Open the LCD monitor.

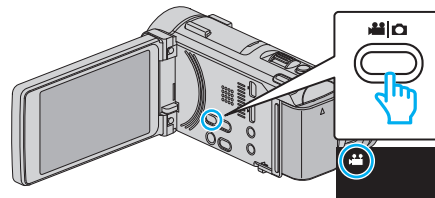

- Check if the recording mode is

- 2 Tap "MENU".

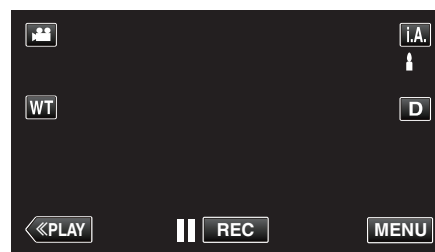

- The shortcut menu appears.

- 3 Tap "MENU" in the shortcut menu.

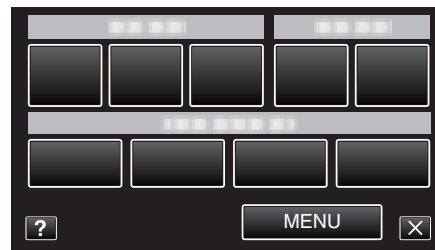

- 4 Tap "x.v.Color".

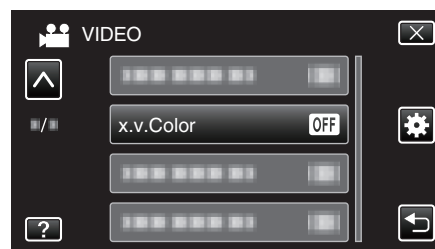

ZOOM MIC

Sets the zoom microphone.

Setting	Details
OFF	Deactivates the zoom microphone.
ON	Records audio sounds in the same direction as the zoom operation.

Displaying the Item

- 1 Open the LCD monitor.

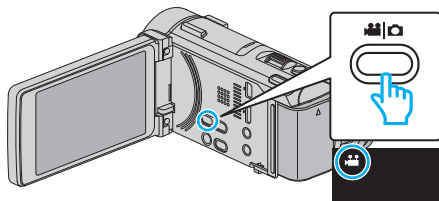

- Check if the recording mode is .

- 2 Tap "MENU".

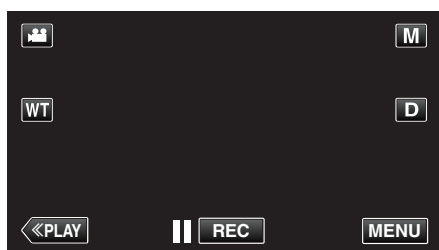

- The shortcut menu appears.

- 3 Tap "MENU" in the shortcut menu.

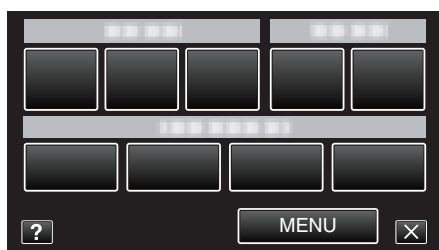

- 4 Tap "ZOOM MIC".

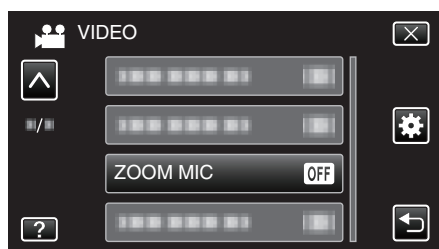

MIC LEVEL

Make the adjustments such that "MIC LEVEL" does not turn red.

Setting	Details
OFF	Hides display of microphone input level.
ON	Shows display of microphone input level.

Displaying the Item

- 1 Open the LCD monitor.

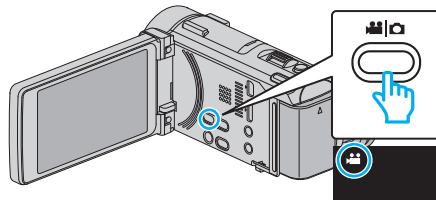

- Check if the recording mode is .

- 2 Tap "MENU".

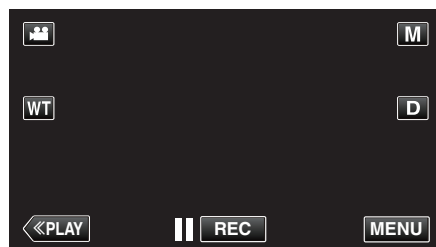

- The shortcut menu appears.

- 3 Tap "MENU" in the shortcut menu.

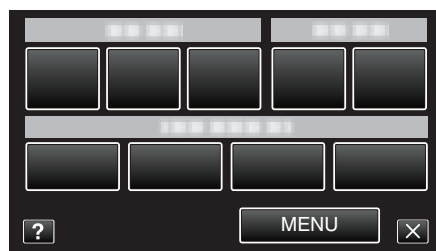

- 4 Tap "MIC LEVEL".

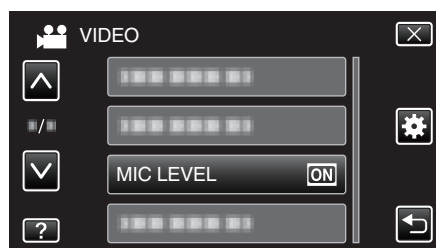

Menu Settings

MIC LEVEL SETTING

Sets the microphone level.
Make the adjustments such that "MIC LEVEL" does not turn red.

Setting	Details
+2	Increases the microphone input level.
+1	Increases the microphone input level slightly.
0	The microphone input level is not changed.
-1	Decreases the microphone input level slightly.
-2	Decreases the microphone input level.

Displaying the Item

- 1 Open the LCD monitor.

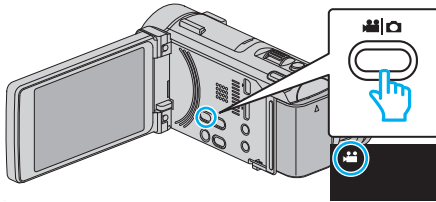

- Check if the recording mode is .

- 2 Tap "MENU".

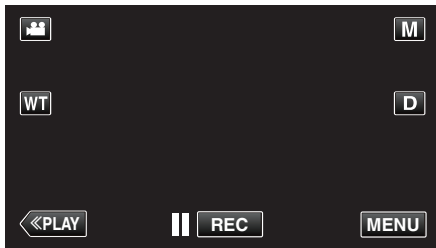

- The shortcut menu appears.

- 3 Tap "MENU" in the shortcut menu.

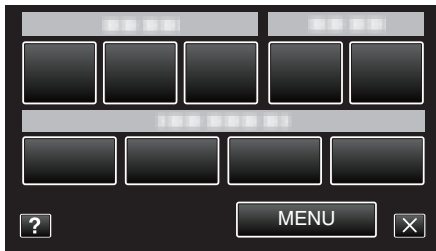

- 4 Tap "MIC LEVEL SETTING".

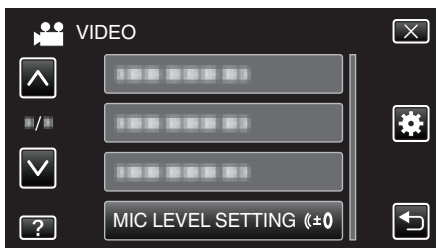

HEADPHONE VOL. ADJ.

Sets the volume level of the connected headphones.

Adjusting the Volume Level of Headphones During Recording

- 1 Open the LCD monitor.

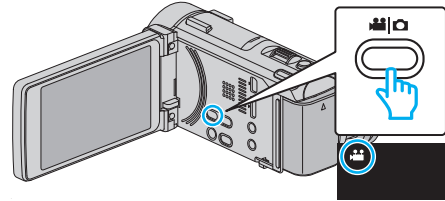

- Check if the recording mode is .

- 2 Tap "MENU".

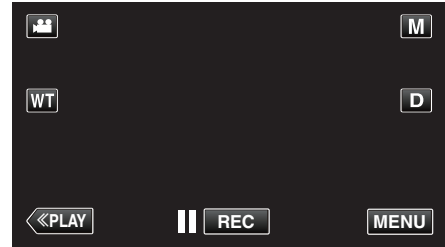

- The shortcut menu appears.

- 3 Tap "MENU" in the shortcut menu.

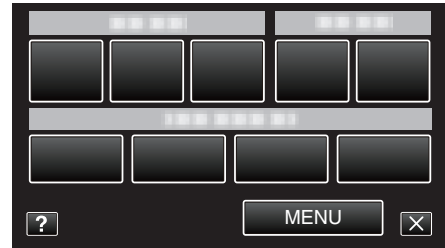

- 4 Tap "HEADPHONE VOL. ADJ.".

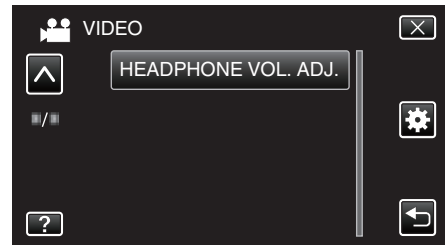

- The volume adjustment screen appears.

- 5 Adjust the volume level of the headphones.



- To turn up the volume, tap + on the touch screen.
- To turn down the volume, tap - on the touch screen.
- Tap X to exit the volume adjustment screen.

Adjusting the Volume Level of Headphones During Playback

- 1 Open the LCD monitor.

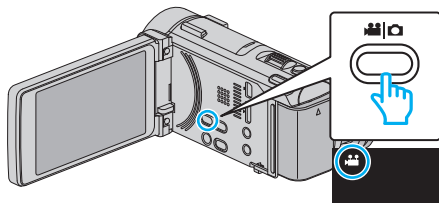

- Check if the recording mode is .

- 2 Tap "<<PLAY" to select the playback mode.

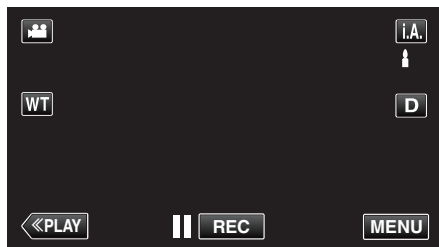

- 3 Tap on the file to start playback.

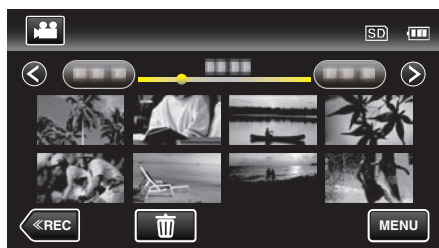

- 4 Adjust the volume level of the headphones.

- To turn up the volume, set the zoom lever to the T end.
- To turn down the volume, set the zoom lever to the W end.

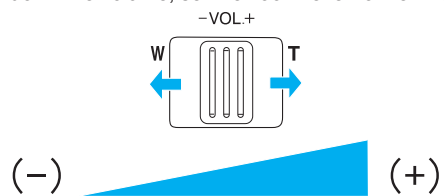

Recording Menu (Still Image)

You can adjust various settings, such as brightness and white balance, to suit the subject or purpose. You can also change settings such as picture quality and gain.

1 Open the LCD monitor.

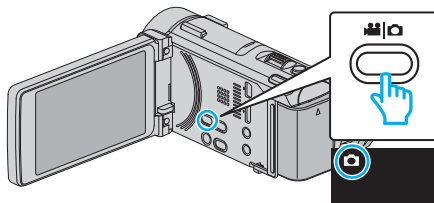

- Check if the recording mode is .

2 Tap "MENU".

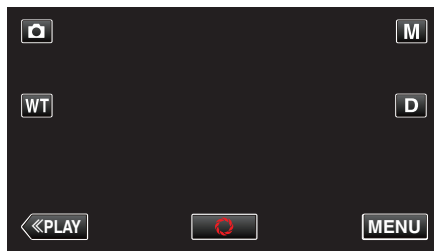

- The shortcut menu appears.

3 Tap "MENU" in the shortcut menu.

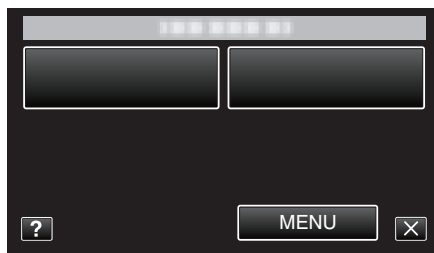

Setting	Details
INFO.	You can check the remaining battery power. "Checking the Remaining Recording Time" (p. 117)
SCENE SELECT	Settings to suit the shooting condition can be selected. "Shooting According to Scene (Subject)" (p. 84) *Displayed only in the manual recording mode.
FOCUS	Focus can be adjusted manually. "Adjusting Focus Manually" (p. 86) *Displayed only in the manual recording mode.
BRIGHTNESS ADJUST	Adjusts the overall brightness of the screen. "Adjusting Brightness" (p. 87) *Displayed only in the manual recording mode.
SHUTTER SPEED	Shutter speed can be adjusted. "Setting Shutter Speed" (p. 88) *Displayed only in the manual recording mode.
APERTURE PRIORITY	Adjusts the aperture value. "Setting Aperture" (p. 89) *Displayed only in the manual recording mode.
WHITE BALANCE	Adjusts the color according to the light source. "Setting White Balance" (p. 90) *Displayed only in the manual recording mode.
BACKLIGHT COMP.	Corrects the image when the subject appears dark due to backlight. "Setting Backlight Compensation" (p. 91) *Displayed only in the manual recording mode.

Setting	Details
TELE MACRO	Enables close-up shots when using the telephoto (T) end of the zoom. “Taking Close-up Shots” (p. 93) *Displayed only in the manual recording mode.
TOUCH PRIORITY AE/AF	Automatically adjusts focus and brightness based on the subjects’ faces or selected area. “Capturing Subjects Clearly (TOUCH PRIORITY AE/AF)” (p. 99)
FLASH	For setting the flash. “FLASH” (p. 186)
SELF-TIMER	Use this when taking a group photo. “Taking Group Shots (Self-timer)” (p. 114)
GAIN	Enables selection of the ISO level. Sets the ISO level according to the brightness of the subject. “GAIN” (p. 187)
AUTO REC	Enables the unit to record still images automatically by sensing the changes in brightness within the red frame displayed on the LCD monitor. “Recording Automatically by Sensing Movements (AUTO REC)” (p. 113)
SHUTTER MODE	Continuous shooting settings can be adjusted. “SHUTTER MODE” (p. 188)
CONT. SHOOTING SPEED	Sets the speed for continuous shooting. “CONT. SHOOTING SPEED” (p. 189)
SMILE SHOT	Automatically captures a still image upon detection of a smile. “Capturing Smiles Automatically (SMILE SHOT)” (p. 100)
SMILE%/NAME DISPLAY	Sets the items to display when faces are detected. “Setting SMILE%/NAME DISPLAY” (p. 107)
FACE REGISTRATION	Registers the faces of people who are often shot with this unit. “Registering Human Face Personal Authentication Information” (p. 105)
PET SHOT	Automatically captures a still image upon detection of the face of a pet, such as dogs or cats. “Capturing Pets Automatically (PET SHOT)” (p. 102)
IMAGE SIZE	Sets the image size (number of pixels) for still images. “IMAGE SIZE” (p. 190)
GRID	Displays gridlines to make it easier to detect when the subject appears slanted. “GRID” (p. 190)

Menu Settings

INFO.

You can check the remaining battery power.
Operating Details
“Checking the Remaining Recording Time” (p. 117)

SCENE SELECT

Settings to suit the shooting condition can be selected.
Operating Details
“Shooting According to Scene (Subject)” (p. 84)

FOCUS

Focus can be adjusted manually.
Operating Details
“Adjusting Focus Manually” (p. 86)

BRIGHTNESS ADJUST

Adjusts the overall brightness of the screen.
Operating Details
“Adjusting Brightness” (p. 87)

SHUTTER SPEED

Shutter speed can be adjusted.
Operating Details
“Setting Shutter Speed” (p. 88)

APERTURE PRIORITY

Adjusts the aperture value.
Operating Details
“Setting Aperture” (p. 89)

WHITE BALANCE

Adjusts the color according to the light source.
Operating Details
“Setting White Balance” (p. 90)

BACKLIGHT COMP.

Corrects the image when the subject appears dark due to backlight.
Operating Details
“Setting Backlight Compensation” (p. 91)

TELE MACRO

Enables close-up shots when using the telephoto (T) end of the zoom.
Operating Details
“Taking Close-up Shots” (p. 93)

TOUCH PRIORITY AE/AF

Automatically adjusts focus and brightness based on the subjects' faces or selected area.
Operating Details
“Capturing Subjects Clearly (TOUCH PRIORITY AE/AF)” (p. 99)

FLASH

For setting the flash.

Setting	Details
OFF	Flash does not fire.
AUTO	Flash fires automatically when the surrounding is dark.
AUTO RED-EYE	Fires a pre-flash to reduce red-eye effects.
ON	Fires flash at all times.
SLOW SYNCHRO	Fires flash at all times, and slows down the shutter speed to capture both the subject and background brightly.

Memo :

- The flash icon displayed on the screen blinks while the flash is charging.
- The flash does not fire when “ISO6400” in “GAIN”, “NIGHTALIVE”, “NIGHT”, or “SNOW” in “SCENE SELECT”, or “SHUTTER MODE” are set.

Displaying the Item

- 1 Select still image mode.

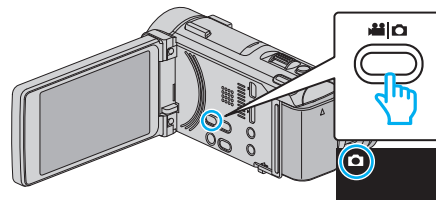

- Check if the recording mode is .

- 2 Tap “MENU”.

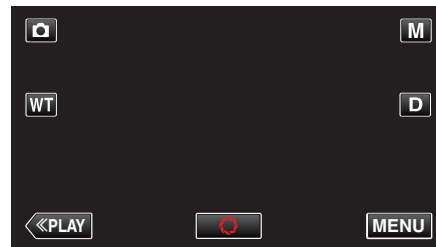

- The shortcut menu appears.

- 3 Tap “MENU” in the shortcut menu.

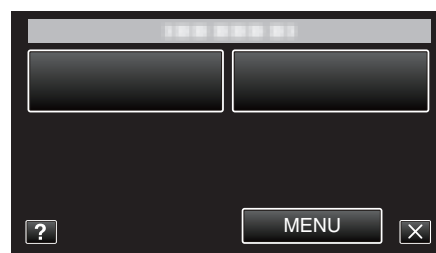

- 4 Tap “FLASH”.

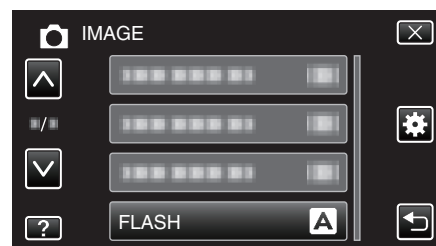

Warning

- Do not point the AF assist beam of the flash at the eyes within a close range (several cm).
- Do not look into the flash light directly.
- Incorrect usage of the flash may cause vision problems.
- Keep a distance of at least 1 m when shooting young children.
- Using the flash at drivers may cause temporary blindness and result in accidents.

Caution :

- Do not fire the AF assist beam of the flash at the subjects within a close range (several cm).
- Do not touch it directly with your hand.
- If foreign particles, such as dust, are attached, do not use it.
- Also, do not cover it with tape, etc.
- Incorrect usage may result in burns.
- Heat from the flash may result in emission of smoke.
- Do not touch the flash immediately after it is used.

SELF-TIMER

Use this when taking a group photo.
 Operating Details
 "Taking Group Shots (Self-timer)" (p. 114)

GAIN

Enables selection of the ISO level.

Setting	Details
AUTO	Adjusts the ISO level automatically according to the brightness of the subject.
ISO100 ISO200 ISO400 ISO800 ISO1600 ISO3200 ISO6400	Records with a fixed ISO level.

Memo :

- The flash cannot be used when "ISO6400" is set.
- The higher the ISO level, the grainier the image becomes due to noise.

Displaying the Item

1 Select still image mode.

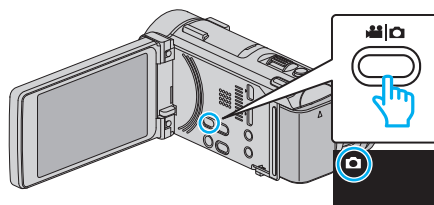

- Check if the recording mode is .

2 Tap "MENU".

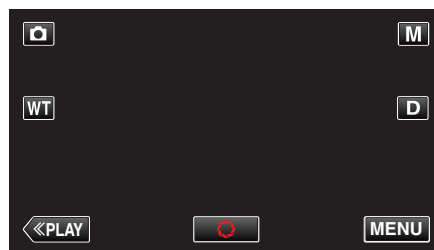

- The shortcut menu appears.

3 Tap "MENU" in the shortcut menu.

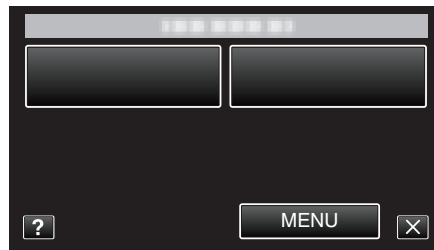

4 Tap "GAIN".

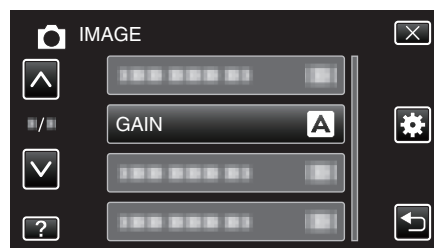

AUTO REC

Starts recording automatically by sensing the changes in subject's movement (brightness) within the red frame displayed on the LCD monitor.
 Operating Details
 "Recording Automatically by Sensing Movements (AUTO REC)"
 (p. 113)

SHUTTER MODE

Continuous shooting settings can be adjusted.

Setting	Details
RECORD ONE SHOT	Records one still image.
CONTINUOUS SHOOTING	Records still images continuously while the SNAPSHOT button is pressed.

Memo :

- The continuous shooting speed can be changed.
 "CONT. SHOOTING SPEED" (p. 189)
- Continuous shooting is not available when image size is set to 3968x2976.
- Some SD cards may not support continuous shooting.
- The continuous shooting speed will drop if this function is used repeatedly.

Displaying the Item

1 Open the LCD monitor.

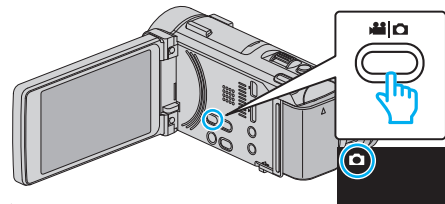

- Check if the recording mode is .

2 Tap "MENU".

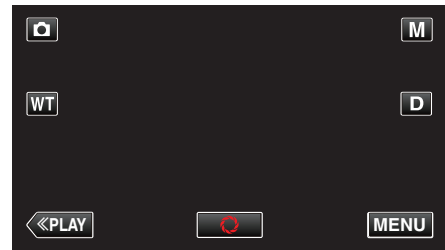

- The shortcut menu appears.

3 Tap "MENU" in the shortcut menu.

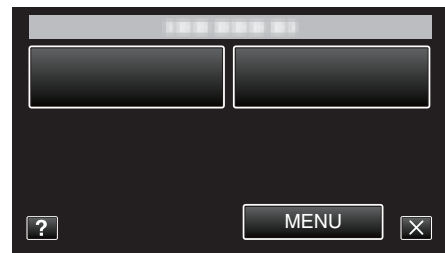

4 Tap "SHUTTER MODE".

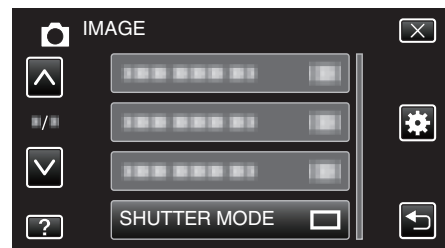

CONT. SHOOTING SPEED

Sets the speed for continuous shooting.

Setting	Details
HIGH SPEED	<ul style="list-style-type: none"> Shoots up to 95 still images continuously in the still image mode in about 6.3 second. Shoots up to 90 still images continuously in the video mode in about 1.5 second.
MEDIUM SPEED	<ul style="list-style-type: none"> Shoots up to 95 still images continuously in the still image mode in about 12.6 second. Shoots up to 90 still images continuously in the video mode in about 9 second.
LOW SPEED	Shoots continuously until the recording media is full.

Memo :

- Shooting speed slows down gradually as continuous shooting goes on in the "LOW SPEED" mode.
- "HIGH SPEED" and "MEDIUM SPEED" are not available when image size is set to "2656X1992(5.3M)" in the still image recording mode.
- Performing continuous shooting while video recording is in progress sets the mode to "LOW SPEED" temporarily.

Displaying the Item

1 Open the LCD monitor.

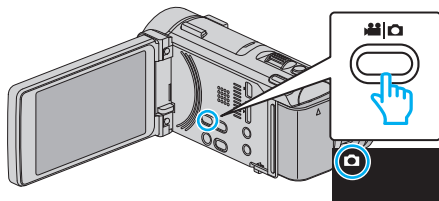

- Check if the recording mode is .

2 Tap "MENU".

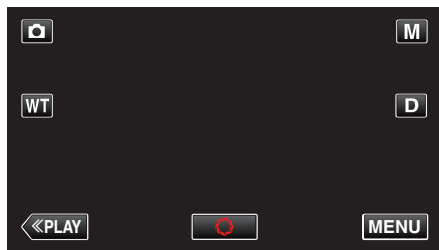

- The shortcut menu appears.

3 Tap "MENU" in the shortcut menu.

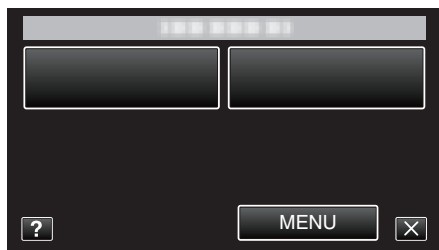

4 Tap "CONT. SHOOTING SPEED".

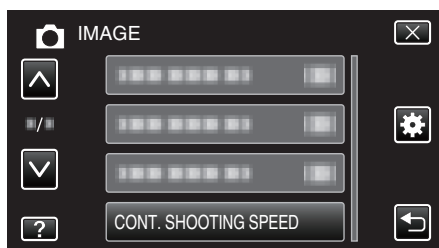

SMILE SHOT

Automatically captures a still image upon detection of a smile.

Operating Details

"Capturing Smiles Automatically (SMILE SHOT)" (p. 100)

SMILE%/NAME DISPLAY

Sets the items to display when faces are detected.

Operating Details

"Setting SMILE%/NAME DISPLAY" (p. 107)

FACE REGISTRATION

Registers the faces of people who are often shot with this unit.

Operating Details

"Registering Human Face Personal Authentication Information" (p. 105)

PET SHOT

Automatically captures a still image upon detection of the face of a pet, such as dogs or cats.

Operating Details

"Capturing Pets Automatically (PET SHOT)" (p. 102)

Menu Settings

IMAGE SIZE

Sets the image size (number of pixels) for still images.

Setting	Details
1920X1080(2M)	Takes still images with aspect ratio 16:9. <ul style="list-style-type: none"> The sides of still images recorded in 16:9 aspect ratio may be cut off when printed.
3968X2976(11.8M) 2656X1992(5.3M) 1920X1440(2.8M) 640X480(0.3M)	Takes still images with aspect ratio 4:3.

Displaying the Item

- 1 Open the LCD monitor.

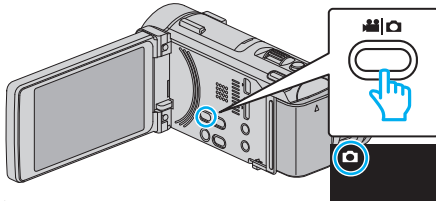

- Check if the recording mode is

- 2 Tap "MENU".

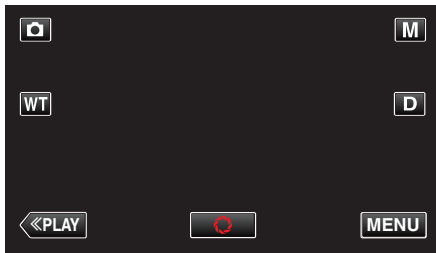

- The shortcut menu appears.

- 3 Tap "MENU" in the shortcut menu.

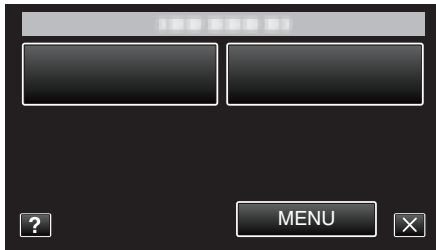

- 4 Tap "IMAGE SIZE".

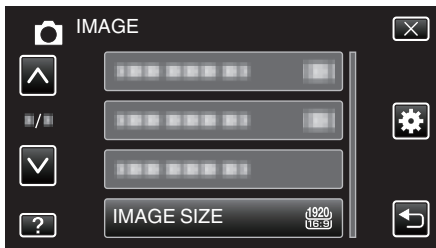

GRID

Displays gridlines to make it easier to detect when the subject appears slanted.

Setting	Details
OFF	Turns off grid display.
ON	Turns on grid display.

Displaying the Item

- 1 Select still image mode.

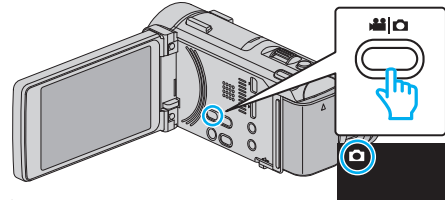

- Check if the recording mode is

- 2 Tap "MENU".

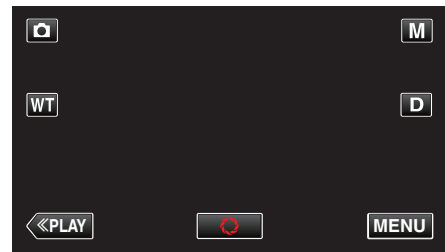

- The shortcut menu appears.

- 3 Tap "MENU" in the shortcut menu.



- 4 Tap "GRID".

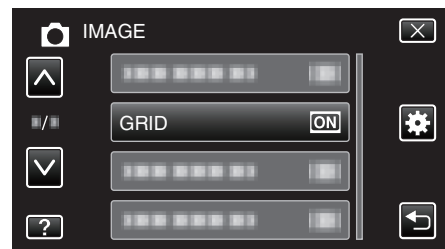

Playback Menu (Video)

You can delete or look for specific videos.

- 1 Open the LCD monitor.

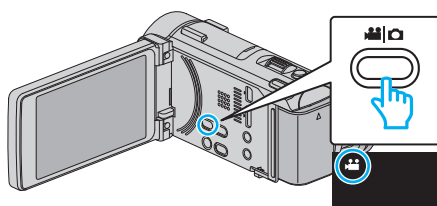

- Check if the recording mode is .

- 2 Tap “<<PLAY” to select the playback mode.

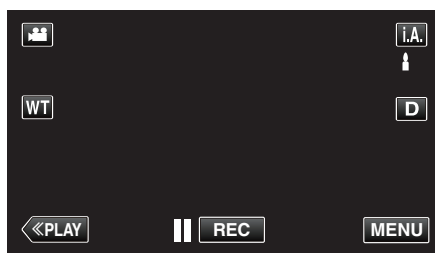

- 3 Tap “MENU”.



Setting	Details
FILE INFORMATION	You can display the recording date and duration of the selected file. “Checking the Recording Date and Other Information” (☞ p. 121)
SEARCH DATE	You can search and play videos or still images according to recording dates. “Searching for a Specific Video/Still Image by Date” (☞ p. 125)
DISPLAY DATE/TIME	Displays the recording date and time during video playback. “DISPLAY DATE/TIME” (☞ p. 192)
DIGEST PLAYBACK	Plays back a digest of the recorded videos. “Checking the Content of Videos Quickly (Digest Playback)” (☞ p. 121)
PLAYBACK PLAYLIST	Plays back the playlists that you have created. “Playing Back Playlists” (☞ p. 127)
EDIT PLAYLIST	Creates or edits a playlist. “Creating Playlists with Selected Files” (☞ p. 135) “Creating Playlists by Date” (☞ p. 136) “Editing Playlists” (☞ p. 137)
PROTECT/CANCEL	Protects files from being deleted accidentally. “Protecting/Releasing Protection of the Currently Displayed File” (☞ p. 130) “Protecting/Releasing Protection of Selected Files” (☞ p. 131)
TRIMMING	Select the required part of a video and save it as a new video file. “Capturing a Required Part in the Video (TRIMMING)” (☞ p. 132)
UPLOAD SETTINGS	Capture and copy a part of a recorded video (maximum 15 minutes) for uploading to YouTube. “UPLOAD SETTINGS” (☞ p. 193)
PLAYBACK OTHER FILE	Plays videos with defective management information. “Playing a Video with Defective Management Information” (☞ p. 122)
K2 TECHNOLOGY	Reproduces small or high-pitched sounds that cannot be recorded during recording, and plays back with a sound quality close to the original. “K2 TECHNOLOGY” (☞ p. 193)

FILE INFORMATION

You can display the recording date and duration of the selected file.
 Operating Details
 “Checking the Recording Date and Other Information” (p. 121)

SEARCH DATE

Narrows down the video index screen according to recording dates.
 Operating Details
 “Searching for a Specific Video/Still Image by Date” (p. 125)

DISPLAY DATE/TIME

Sets whether to display the recording date and time during video playback.

Setting	Details
OFF	Does not display the date and time during playback.
ON	Displays the date and time during playback.

Displaying the Item

- 1 Open the LCD monitor.

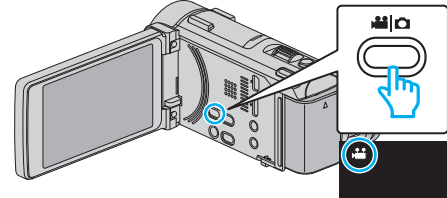

- Check if the recording mode is .

- 2 Tap “<<PLAY” to select the playback mode.

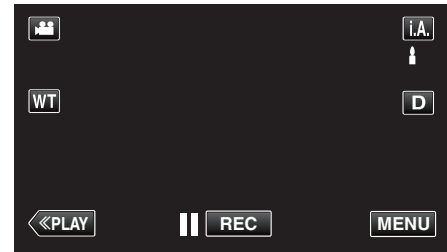

- 3 Tap “MENU”.

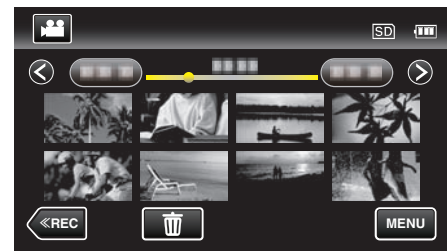

- 4 Tap “DISPLAY DATE/TIME”.

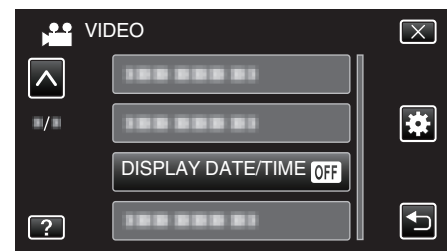

DIGEST PLAYBACK

Plays back a digest of the recorded videos.

Operating Details

“Checking the Content of Videos Quickly (Digest Playback)” (☞ p. 121)

PLAYBACK PLAYLIST

Plays back the playlists that you have created.

Operating Details

“Playing Back Playlists” (☞ p. 127)

EDIT PLAYLIST

A list in which your favorite videos are arranged is called a playlist.

By creating a playlist, you can play back only your favorite videos in the order you like.

The original video file remains even when it is registered to a playlist.

Operating Details

“Creating Playlists with Selected Files” (☞ p. 135)

“Creating Playlists by Date” (☞ p. 136)

“Editing Playlists” (☞ p. 137)

PROTECT/CANCEL

Protects files from being deleted accidentally.

Operating Details

“Protecting/Releasing Protection of the Currently Displayed File” (☞ p. 130)

“Protecting/Releasing Protection of Selected Files” (☞ p. 131)

TRIMMING

Select the required part of a video and save it as a new video file.

Operating Details

“Capturing a Required Part in the Video (TRIMMING)” (☞ p. 132)

UPLOAD SETTINGS

Capture and copy a part of a recorded video (maximum 15 minutes) for uploading to YouTube.

Operating Details

“Capturing Videos for Uploading to YouTube” (☞ p. 133)

PLAYBACK OTHER FILE

Plays videos with defective management information.

Operating Details

“Playing a Video with Defective Management Information” (☞ p. 122)

K2 TECHNOLOGY

Reproduces small or high-pitched sounds that cannot be recorded during recording, and plays back with a sound quality close to the original.

Setting	Details
OFF	Deactivates K2 TECHNOLOGY.
ON	Activates K2 TECHNOLOGY.

Displaying the Item

- 1 Open the LCD monitor.

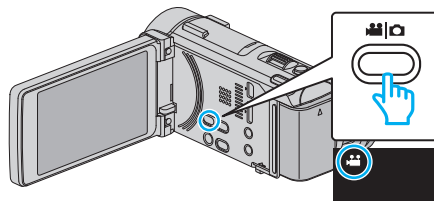

- Check if the recording mode is .

- 2 Tap “<<PLAY” to select the playback mode.

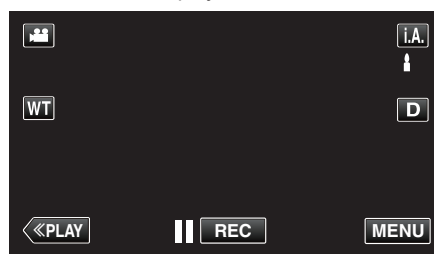

- 3 Tap “MENU”.

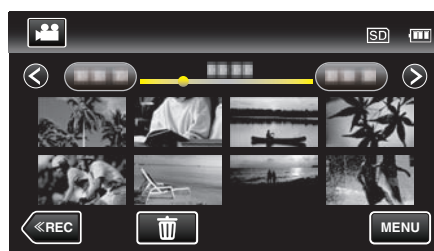

- 4 Tap “K2 TECHNOLOGY”.

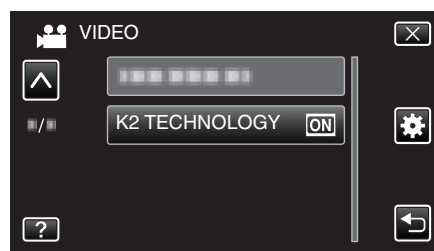

Playback Menu (Still Image)

You can delete or look for specific still images.

- 1 Open the LCD monitor.

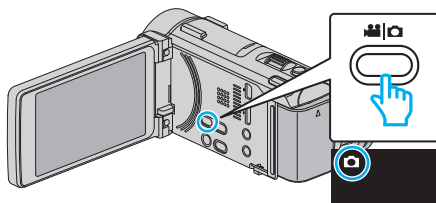

- Check if the recording mode is .

- 2 Tap “<<PLAY” to select the playback mode.

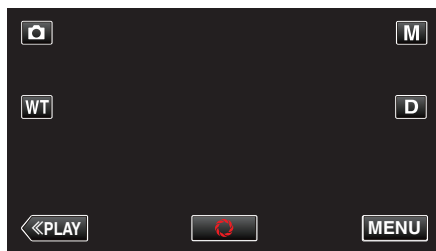

- 3 Tap “MENU”.



Setting	Details
FILE INFORMATION	You can display the recording date and duration of the selected file. “Checking the Recording Date and Other Information” (☞ p. 121)
SEARCH DATE	You can search and play videos or still images according to recording dates. “Searching for a Specific Video/Still Image by Date” (☞ p. 125)
SLIDE SHOW EFFECTS	Sets the transition effects in slideshow playback. “SLIDE SHOW EFFECTS” (☞ p. 195)
PROTECT/CANCEL	Protects files from being deleted accidentally. “Protecting/Releasing Protection of the Currently Displayed File” (☞ p. 130) “Protecting/Releasing Protection of Selected Files” (☞ p. 131)

FILE INFORMATION

You can display the recording date and duration of the selected file.

Operating Details

“Checking the Recording Date and Other Information” (☞ p. 121)

SEARCH DATE

Narrows down the still image index screen according to recording dates.

Operating Details

“Searching for a Specific Video/Still Image by Date” (☞ p. 125)

SLIDE SHOW EFFECTS

Sets the transition effects in slideshow playback.

Setting	Details
SLIDE	Switches the screen by sliding in from right to left.
BLINDS	Switches the screen by dividing into vertical strips.
CHECKERBOARD	Switches the screen by changing through a checkered pattern.
RANDOM	Switches the screen with a random effect from SLIDE, "BLINDS", and "CHECKERBOARD".

Memo :

- Slideshow effects are not available when playing back still images in external devices (such as USB external hard disk drives).

Displaying the Item

- 1 Open the LCD monitor.

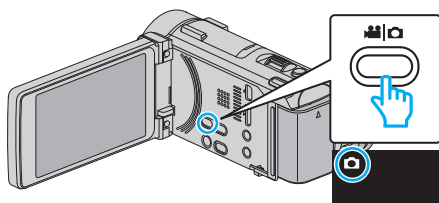

- Check if the recording mode is .

- 2 Tap "<<PLAY" to select the playback mode.

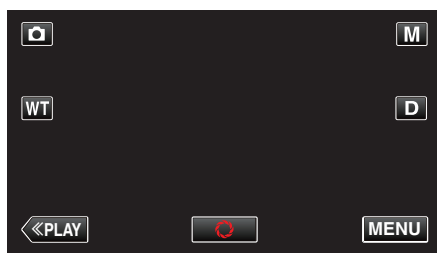

- 3 Tap "MENU".

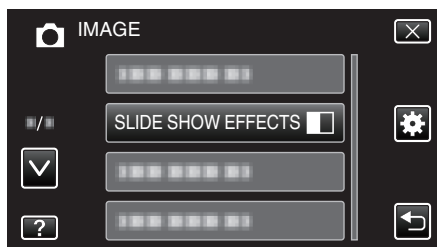

- 4 Tap "SLIDE SHOW EFFECTS".

**PROTECT/CANCEL**

Protects files from being deleted accidentally.

Operating Details

"Protecting/Releasing Protection of the Currently Displayed File"
( p. 130)

"Protecting/Releasing Protection of Selected Files" ( p. 131)

Common Menu

1 Tap "MENU".

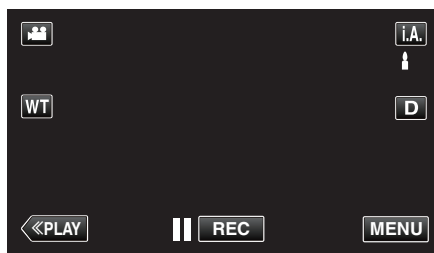

- When entering from the recording mode, tap "MENU" again as the shortcut menu appears.

2 Tap "⚙️".



Setting	Details
CLOCK ADJUST	Resets the current time or sets to the local time when using this unit overseas. "Clock Setting" (☞ p. 69) "Setting the Clock to Local Time when Traveling" (☞ p. 74) "Setting Daylight Saving Time" (☞ p. 74)
DATE DISPLAY STYLE	Sets the order of year, month, day and the time display format (24H/12H). "DATE DISPLAY STYLE" (☞ p. 198)
LANGUAGE	The language on the display can be changed. "Changing the Display Language" (☞ p. 70)
MONITOR BRIGHTNESS	Sets the brightness of the LCD monitor. "MONITOR BRIGHTNESS" (☞ p. 198)
OPERATION SOUND	Turns on or off the operation sound. "OPERATION SOUND" (☞ p. 199)
SILENT MODE	Sets to the Silent mode in which operation sounds are turned off and the brightness of the screen is reduced. "SILENT MODE" (☞ p. 199)
AUTO POWER OFF	Prevents the situation of forgetting to turn off the power when this is set. "AUTO POWER OFF" (☞ p. 200)
QUICK RESTART	Reduces the power consumption within 5 minutes after the LCD monitor is closed to 1/3 of that used during recording. "QUICK RESTART" (☞ p. 200)
REMOTE	Enables remote control operation. "REMOTE" (☞ p. 201)
DEMO MODE	Introduces the special features of this unit in digest form. "DEMO MODE" (☞ p. 201)

Setting	Details
TOUCH SCREEN ADJUST	Adjusts the response position of the buttons on the touch screen. “ TOUCH SCREEN ADJUST ” (☞ p. 202)
DISPLAY ON TV	Displays icons and date/time on a TV screen. “ DISPLAY ON TV ” (☞ p. 203)
VIDEO OUTPUT	Sets the aspect ratio (16:9 or 4:3) according to the connecting TV. “ VIDEO OUTPUT ” (☞ p. 203)
HDMI OUTPUT	Sets the definition of the video output from the HDMI mini connector. “ HDMI OUTPUT ” (☞ p. 204)
HDMI CONTROL	Sets the linked operations ON/OFF when the TV and this unit are connected using the HDMI mini connector. “ HDMI CONTROL ” (☞ p. 204)
FACTORY PRESET	Returns all the settings to their default values. “ FACTORY PRESET ” (☞ p. 205)
UPDATE	Updates the functions of this unit to the latest version. “ UPDATE ” (☞ p. 205)
FORMAT SD CARD	Deletes all files on the SD card. “ FORMAT SD CARD ” (☞ p. 205)
OPEN SOURCE LICENSES	Displays the open source software licenses that are used in this unit. (recording mode only) “ OPEN SOURCE LICENSES ” (☞ p. 205)
MOBILE USER GUIDE	Displays the QR code to access the Mobile User Guide. “ MOBILE USER GUIDE ” (☞ p. 206)

Menu Settings

CLOCK ADJUST

Resets the current time or sets to the local time when using this unit overseas.

Operating Details

“Clock Setting” (☞ p. 69)

“Setting the Clock to Local Time when Traveling” (☞ p. 74)

“Setting Daylight Saving Time” (☞ p. 74)

DATE DISPLAY STYLE

Sets the order of year, month, day and the time display format (24H/12H).

1 Tap “MENU”.

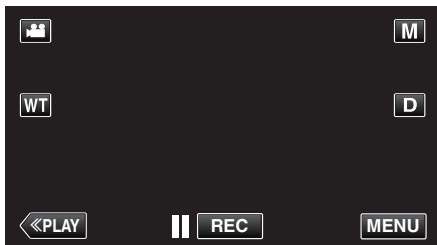

- When entering from the recording mode, tap “MENU” again as the shortcut menu appears.

2 Tap “⚙️”.



3 Tap “DATE DISPLAY STYLE”.

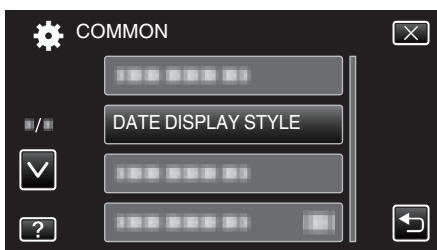

4 Tap to set the style of date and time display.

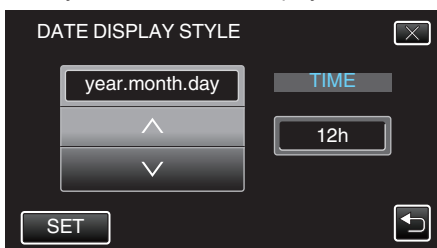

- For date display, set to any format from “month.day.year”, “year.month.day”, and “day.month.year”.
- For time display, set to any format from “12h” and “24h”.
- Tap ^ or v to change the display style.
- After setting, tap “SET”.

LANGUAGE

The language on the display can be changed.

Operating Details

“Changing the Display Language” (☞ p. 70)

MONITOR BRIGHTNESS

Sets the brightness of the LCD monitor.

Setting	Details
AUTO	Sets the brightness automatically to “4” when using outdoors and to “3” when using indoors.
4	Brightens the backlight of the monitor regardless of the surrounding conditions.
3	Sets to the standard brightness.
2	Darkens the backlight of the monitor regardless of the surrounding conditions.
1	Sets to dim brightness. Helps to save battery life when selected.

Adjusting Monitor Brightness

1 Tap “MENU”.

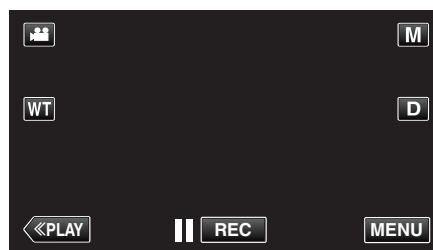

- When entering from the recording mode, tap “MENU” again as the shortcut menu appears.

2 Tap “⚙️”.



3 Tap “MONITOR BRIGHTNESS”.

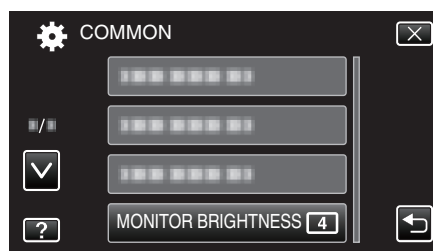

4 Tap the desired monitor brightness.

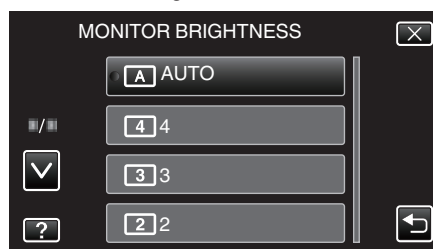

- Tap ^ or v to move upward or downward for more selection.

OPERATION SOUND

Turns on or off the operation sound.

Setting	Details
OFF	Turns off the operation sound.
ON	Turns on the operation sound.

Displaying the Item

- 1 Tap "MENU".

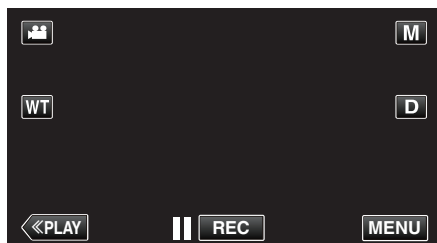

- When entering from the recording mode, tap "MENU" again as the shortcut menu appears.

- 2 Tap "⚙️".



- 3 Tap "OPERATION SOUND".

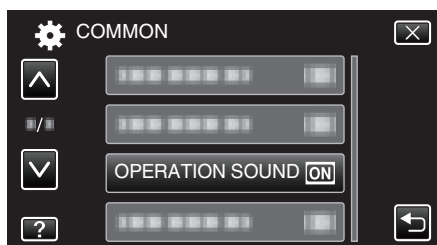

SILENT MODE

When the Silent mode is used, the LCD monitor darkens and operation sounds will not be output. Use this mode to record quietly in dark places such as during a performance.

Setting	Details
OFF	Turns off the Silent mode.
ON	Turns on the Silent mode.

Displaying the Item

- 1 Tap "MENU".

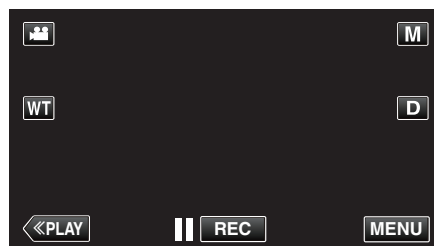

- When entering from the recording mode, tap "MENU" again as the shortcut menu appears.

- 2 Tap "⚙️".



- 3 Tap "SILENT MODE".

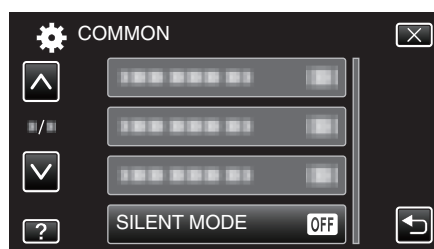

Memo :

- appears when "SILENT MODE" is set to "ON".
- You can also turn on the Silent mode using the SILENT button on this unit. "SILENT Button" (🔊 p. 208)
- It may be difficult to see the screen in Silent mode as the LCD monitor darkens. Set "SILENT MODE" to "OFF" for normal recordings.
- Brightness of the screen remains the same as usual in the playback mode. However, operation and playback sounds will not be output.
- When connected to external devices such as a computer or BD writer via USB, "SILENT MODE" will be turned off temporarily.

Menu Settings

AUTO POWER OFF

Prevents the situation of forgetting to turn off the power when this is set.

Setting	Details
OFF	Power is not turned off even if this unit is not operated for 5 minutes.
ON	Turns off the power automatically if this unit is not operated for 5 minutes.

Memo :

- When using battery, power is turned off automatically if this unit is not operated for 5 minutes.
- When using the AC adapter, this unit goes into standby mode.

Displaying the Item

- 1 Tap "MENU".

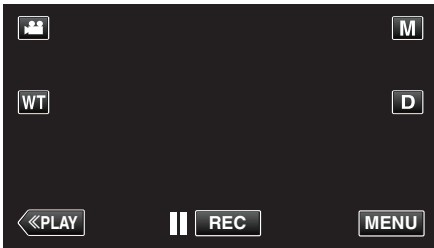

- When entering from the recording mode, tap "MENU" again as the shortcut menu appears.

- 2 Tap "⚙️".



- 3 Tap "AUTO POWER OFF".

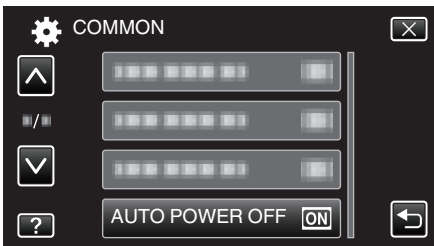

QUICK RESTART

Enables the power to turn on quickly when the LCD monitor is opened again within 5 minutes.

Setting	Details
OFF	Deactivates the function.
ON	Enables the power to turn on quickly when the LCD monitor is opened again within 5 minutes.

Memo :

- The power consumption within 5 minutes after the LCD monitor is closed is reduced.

Displaying the Item

- 1 Tap "MENU".

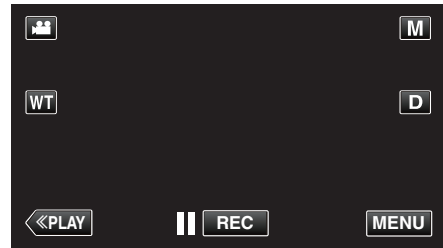

- When entering from the recording mode, tap "MENU" again as the shortcut menu appears.

- 2 Tap "⚙️".



- 3 Tap "QUICK RESTART".

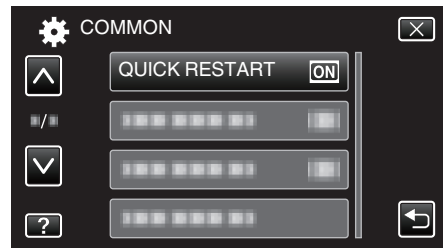

- The power consumption within 5 minutes after the LCD monitor is closed is reduced.

REMOTE

Enables remote control operation.

Setting	Details
OFF	Disables remote control operation.
ON	Enables remote control operation.

Displaying the Item

1 Tap "MENU".

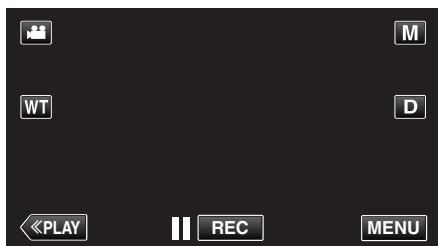

- When entering from the recording mode, tap "MENU" again as the shortcut menu appears.

2 Tap "⚙️".



3 Tap "REMOTE".

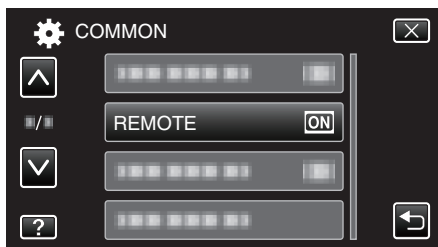

DEMO MODE

Plays a demonstration of the special features of this unit.

Setting	Details
OFF	Deactivates the function.
ON	Plays a demonstration of the special features of this unit.

Displaying Demo Mode

- 1 Remove the battery pack and SD card.
- 2 Connect the AC adapter.
- 3 Open the LCD monitor and turn on the power.

- Demonstration starts playing after 3 minutes.
- To stop playback, tap on the screen.

Memo :

- This mode is not available in the playback mode.
- "SMILE%/NAME DISPLAY" is set to "ON" when the demo mode is activated.

"Setting SMILE%/NAME DISPLAY" (p. 107)

Displaying the Item

1 Tap "MENU".

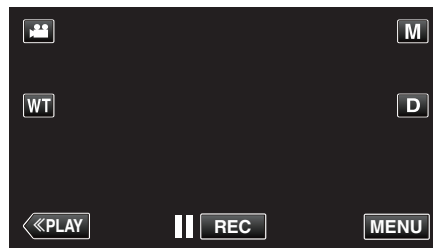

- When entering from the recording mode, tap "MENU" again as the shortcut menu appears.

2 Tap "⚙️".



3 Tap "DEMO MODE".

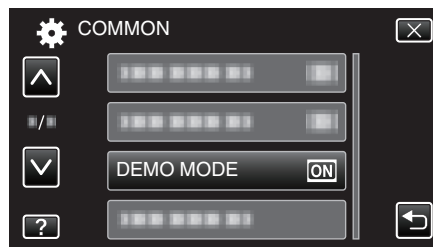

Menu Settings

TOUCH SCREEN ADJUST

Adjusts the response position of the buttons on the touch screen.

1 Tap "MENU".

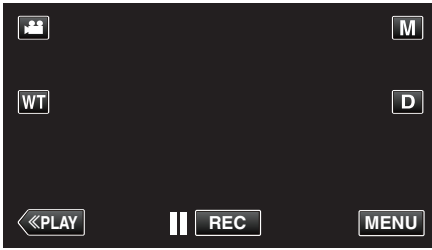

- When entering from the recording mode, tap "MENU" again as the shortcut menu appears.

2 Tap "⚙️".



3 Tap "TOUCH SCREEN ADJUST".

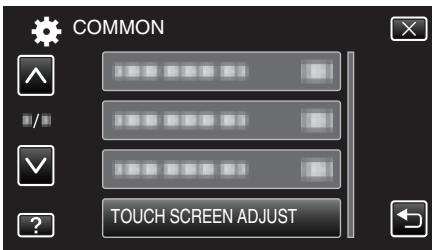

- The touch screen adjustment screen appears.

4 Tap "+". (3 times in total)



- Keep tapping "+" as its position changes with every tap.

5 Tap "+" again to confirm the adjusted positions. (3 times in total)



- Keep tapping "+" as its position changes with every tap.
- If areas on the adjustment screen other than the "+" mark are tapped, errors will occur. In this case, try again from step 4.

6 Tap "OK".

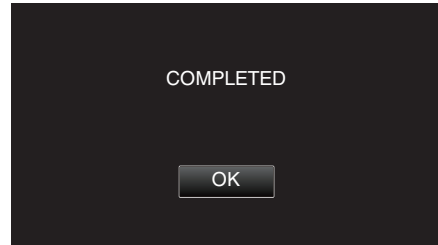

- Setting ends and returns to the menu screen.

Caution :

- Do not tap areas other than the "+" mark during touch screen adjustment (steps 4 - 5). Doing so may cause the touch screen to malfunction.

Memo :

- Adjust by lightly tapping with the stylus pen.
- Do not press with an object with a sharp tip or do not press hard.

DISPLAY ON TV

Displays icons and date/time on a TV screen.

Setting	Details
OFF	Does not display icons and date/time on TV.
ON	Displays icons and date/time on TV.

Displaying the Item

1 Tap "MENU".

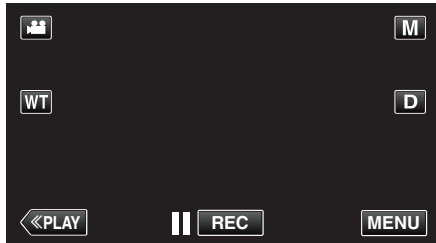

- When entering from the recording mode, tap "MENU" again as the shortcut menu appears.

2 Tap "⚙️".



3 Tap "DISPLAY ON TV".

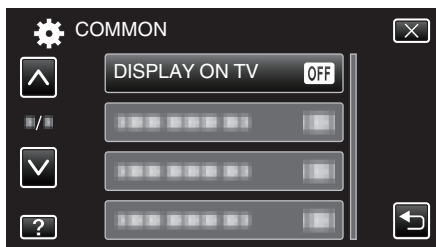

VIDEO OUTPUT

Sets the aspect ratio (16:9 or 4:3) according to the connecting TV.

Setting	Details
4:3	Select this when connecting to a conventional TV (4:3).
16:9	Select this when connecting to a widescreen TV (16:9).

Displaying the Item

1 Tap "MENU".

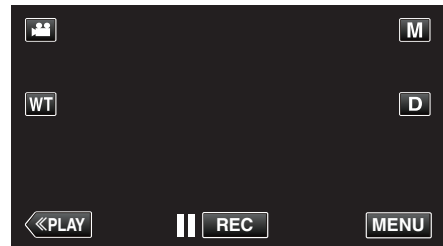

- When entering from the recording mode, tap "MENU" again as the shortcut menu appears.

2 Tap "⚙️".



3 Tap "VIDEO OUTPUT".

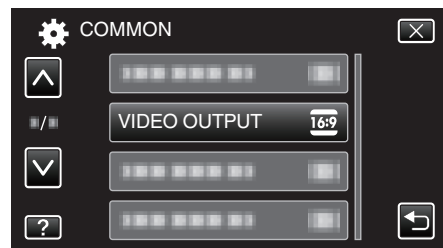

Menu Settings

HDMI OUTPUT

Sets the output from the HDMI connector of this unit when it is connected to a TV.

Setting	Details
AUTO	It is recommended to select "AUTO" usually.
480p	Select this when the video is not output in "AUTO" correctly.

Displaying the Item

- 1 Tap "MENU".

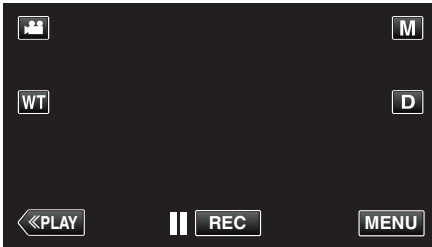

- When entering from the recording mode, tap "MENU" again as the shortcut menu appears.

- 2 Tap "⚙️".



- 3 Tap "HDMI OUTPUT".

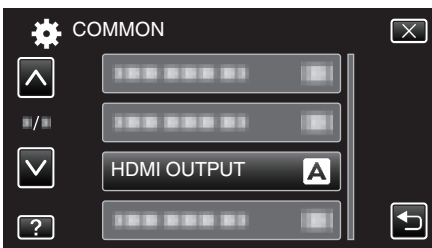

HDMI CONTROL

Sets whether to link operations with an HDMI-CEC compliant TV.

Setting	Details
OFF	Turns off linked operations.
ON	Turns on linked operations.

Displaying the Item

- 1 Tap "MENU".

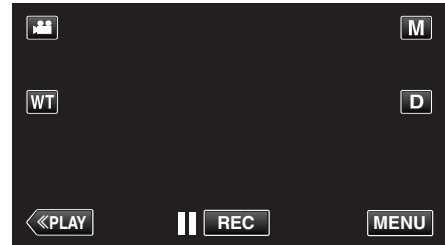

- When entering from the recording mode, tap "MENU" again as the shortcut menu appears.

- 2 Tap "⚙️".



- 3 Tap "HDMI CONTROL".

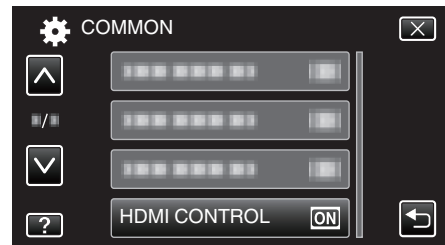

FACTORY PRESET

Returns all the settings to their default values.

1 Tap "MENU".

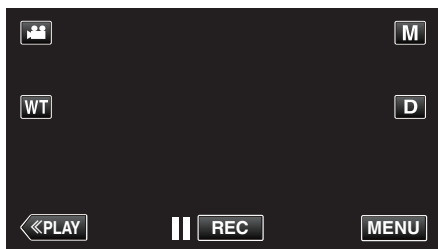

- When entering from the recording mode, tap "MENU" again as the shortcut menu appears.

2 Tap "⚙️".



3 Tap "FACTORY PRESET".



4 Tap "YES".

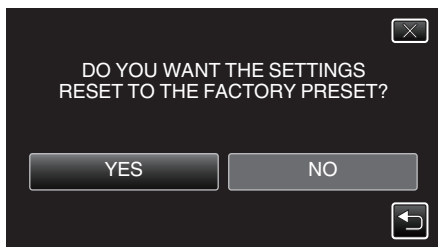

- All settings return to their default values.

UPDATE

Updates the functions of this unit to the latest version.

For details, refer to the JVC homepage.

(When no program to update the software of this unit is available, nothing will be provided on the homepage.)

<http://www3.jvckenwood.com/english/support/index.html>

FORMAT SD CARD

Deletes all files on the SD card.

Setting	Details
FILE	Deletes all files on the SD card.
FILE + MANAGEMENT NO	Deletes all files on the SD card and resets the folder and file numbers to "1".

Caution :

- Not available for selection when no SD card is inserted.
- All data on the SD card will be deleted when it is formatted. Copy all files on the SD card to a computer before formatting.
- Make sure that the battery pack is fully charged or connect the AC adapter as the formatting process may take some time.

Displaying the Item

1 Tap "MENU".

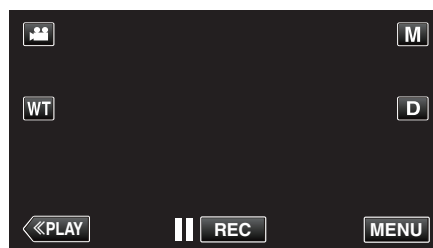

- When entering from the recording mode, tap "MENU" again as the shortcut menu appears.

2 Tap "⚙️".



3 Tap "FORMAT SD CARD".

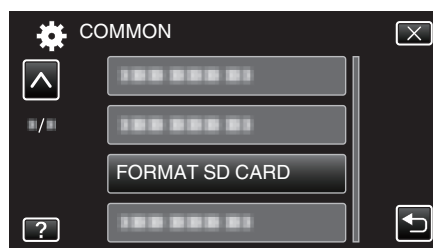

OPEN SOURCE LICENSES

Displays the open source software licenses that are used in this unit.

Menu Settings

MOBILE USER GUIDE

Displays the QR code to access the Mobile User Guide.

1 Tap "MENU".

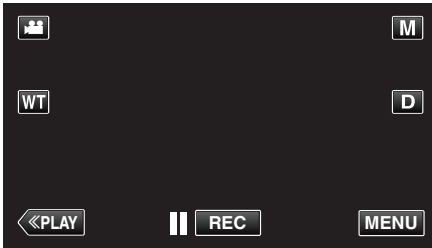

- When entering from the recording mode, tap "MENU" again as the shortcut menu appears.

2 Tap "⚙️".



3 Tap "MOBILE USER GUIDE".

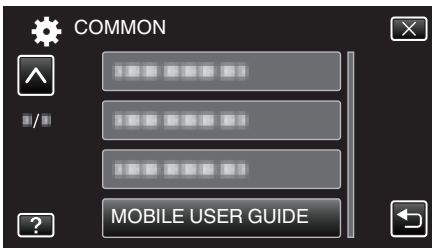

4 Read the QR code (bar code) with a smartphone.



- The portal site appears when the QR code has been read correctly. Select the model name of your camera to display its Mobile User Guide.

Memo :

- To read the QR code, a relevant application is required. Enter the URL in the internet browser manually if the QR code cannot be read.
- The Mobile User Guide is supported by Android devices and iPhone. You can view it on standard browsers such as Google Chrome (Android) and Mobile Safari (iPhone).
- QR Code is a registered trademark of Denso Wave Incorporated.

Front

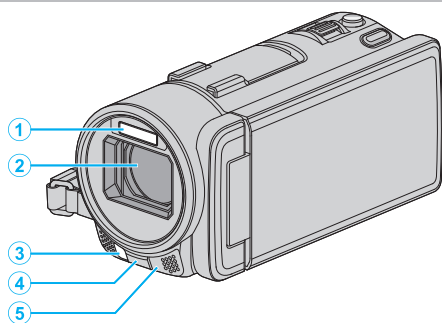

- 1** Flash
“FLASH” (☞ p. 186)
- 2** Lens/Electric Lens Cover
 - Do not touch the lens and lens cover.
 - Do not cover the lens with your fingers during recording.
- 3** Light
 - Turn on the light when shooting in dark places.
 “LIGHT” (☞ p. 175)
- 4** Remote Sensor
“Using the Remote Control” (☞ p. 71)
- 5** Stereo Microphone
 - Do not cover the microphone with your fingers during video recording.

Memo :

- When a lens filter or conversion lens is attached, the flash cannot be used. Set “FLASH” in the menu to “OFF”.
“FLASH” (☞ p. 186)
- When a tele conversion lens is attached, the remote control cannot be used as the sensor will be covered. In addition, white balance may not function properly. Set “WHITE BALANCE” in the Manual mode accordingly.
“Setting White Balance” (☞ p. 90)
- Wide conversion lens cannot be attached.

Rear

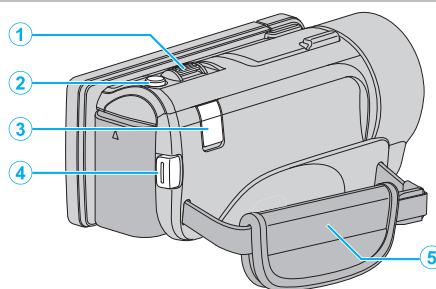

- 1** Zoom/Volume Lever
 - During shooting: Adjusts the shooting range.
 - During playback (index screen): Moves to the next or previous page.
 - During video playback: Adjusts the volume.
- 2** SNAPSHOT (Still Image Recording) Button
 - Takes a still image.
- 3** DC Connector
 - Connects to an AC adapter to charge the battery.
- 4** START/STOP (Video Recording) Button
 - Starts/stops video recording.
- 5** Grip Belt
 - Pass your hand through the grip belt to hold this unit firmly.
 “Grip Adjustment” (☞ p. 65)

Bottom

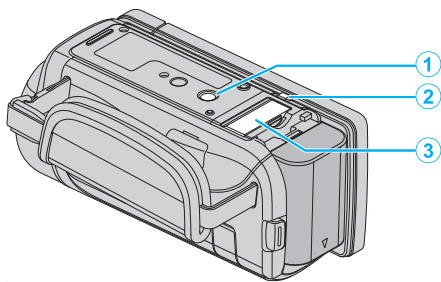

- 1** Tripod Mounting Hole
"Tripod Mounting" (☞ p. 71)
- 2** Battery Release Lever
- 3** SD Card Slot
 - Insert an optional SD card.
"Inserting an SD Card" (☞ p. 65)

Interior

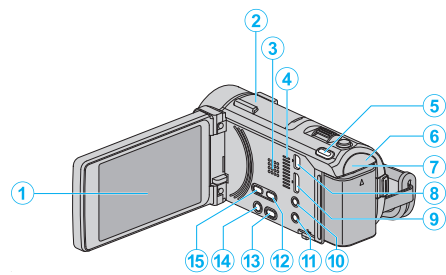

- 1** LCD Monitor
 - Turns the power on/off by opening and closing.
- 2** Shoe Adapter Mount
 - Enables an optional external microphone to be attached.
 - Make sure that it is securely attached and will not fall off.
"Attaching an External Microphone" (☞ p. 73)
- 3** Speaker
 - Outputs audio sound during video playback.
- 4** Exhaust Fan
 - Do not block it with your fingers.
- 5** (🔊) (Image Stabilizer) Button
 - The setting of image stabilizer changes with every press during video recording.
"Reducing Camera Shake" (☞ p. 110)
- 6** POWER/CHARGE (Power/Charge) Lamp
 - Lights up: Power "ON"
 - Blinks: Charging in progress
 - Goes out: Charging finished
- 7** ACCESS (Access) Lamp
 - Lights up/blinks during recording or playback.
Do not remove the battery pack, AC adapter, or SD card.
- 8** USB Connector
 - Connects to computer using a USB cable.
- 9** HDMI Mini Connector
 - Connects to TV using an HDMI mini cable.
- 10** AV/Headphones Connector
 - Connects to the AV connector of a TV, etc.
 - Connects to optional headphones.
"Attaching Headphones" (☞ p. 72)
- 11** Microphone Connector
 - Connects to an optional microphone.
"Attaching an External Microphone" (☞ p. 73)
- 12** PLAY/REC Button
 - Switches between recording and playback modes.
- 13** SILENT Button
 - Press and hold the SILENT button to turn on the Silent mode. To turn it off, press and hold the button again.
"SILENT MODE" (☞ p. 199)
- 14** ⏻ (Power) Button
 - Press and hold to turn the power on/off while the LCD monitor is opened.
- 15** 📹 / 📷 (Video/Still Image) Button
 - Switches between video and still image modes.

LCD Monitor

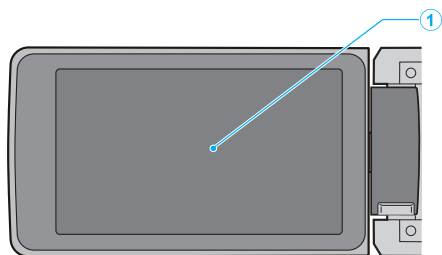

1 LCD Monitor

- Turns the power on/off by opening and closing.
- Enables self-portraits to be taken by rotating the monitor.

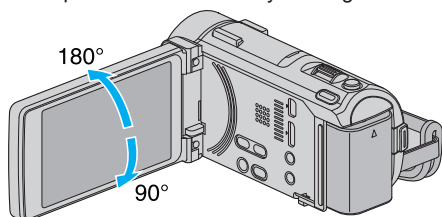

“Using the Touch Screen” (☞ p. 67)

“Names of Buttons and Functions on the LCD Monitor” (☞ p. 67)

Caution :

- Do not press against the surface with force or subject it to strong impact. Doing so may damage or break the screen.

Common Recording Indications

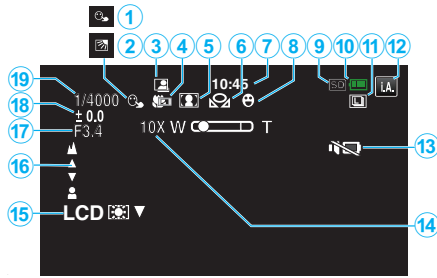

- 1** TOUCH PRIORITY AE/AF
“Capturing Subjects Clearly (TOUCH PRIORITY AE/AF)” (☞ p. 99)
- 2** Backlight Compensation
“Setting Backlight Compensation” (☞ p. 91)
- 3** Auto REC
“Recording Automatically by Sensing Movements (AUTO REC)” (☞ p. 113)
- 4** Tele Macro
“Taking Close-up Shots” (☞ p. 93)
- 5** Scene Select
“Shooting According to Scene (Subject)” (☞ p. 84)
- 6** White Balance
“Setting White Balance” (☞ p. 90)
- 7** Time
“Clock Setting” (☞ p. 69)
- 8** Smile Shot
“Capturing Smiles Automatically (SMILE SHOT)” (☞ p. 100)
- 9** Media
- 10** Battery Indicator
“Checking the Remaining Recording Time” (☞ p. 117)
- 11** Continuous Shooting
“SHUTTER MODE (Video)” (☞ p. 177)
“CONT. SHOOTING SPEED (Video)” (☞ p. 178)
“SHUTTER MODE (Still Image)” (☞ p. 188)
“CONT. SHOOTING SPEED (Still Image)” (☞ p. 189)
- 12** Recording Mode
“Taking Videos in Auto Mode” (☞ p. 76)
“Manual Recording” (☞ p. 82)
- 13** SILENT MODE
“SILENT MODE” (☞ p. 199)
- 14** Zoom
“ZOOM” (☞ p. 180)
- 15** LCD Monitor Brightness
“MONITOR BRIGHTNESS” (☞ p. 198)
- 16** Focus
“Adjusting Focus Manually” (☞ p. 86)
- 17** APERTURE PRIORITY
“Setting Aperture” (☞ p. 89)
- 18** Brightness
“Adjusting Brightness” (☞ p. 87)
- 19** Shutter Speed
“Setting Shutter Speed” (☞ p. 88)

Video Recording

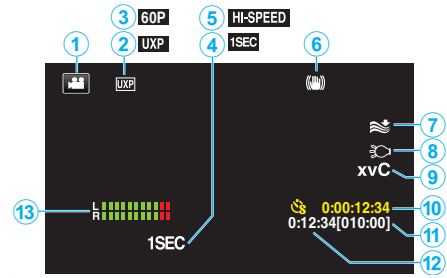

- 1** Video Mode
“Video / Still Image (Video/Still Image) Button” (☞ p. 208)
- 2** Video Quality
“VIDEO QUALITY” (☞ p. 179)
- 3** Progressive Recording
“SYSTEM SELECT” (☞ p. 179)
- 4** TIME-LAPSE RECORDING(1SEC)
“Recording at Intervals (TIME-LAPSE RECORDING)” (☞ p. 111)
- 5** HIGH SPEED RECORDING
“Slow-motion (High-speed) Recording” (☞ p. 110)
- 6** Image Stabilizer
“Reducing Camera Shake” (☞ p. 110)
- 7** Wind Cut
“WIND CUT” (☞ p. 176)
- 8** Light
“LIGHT” (☞ p. 175)
- 9** x.v.Color
“x.v.Color” (☞ p. 180)
- 10** Time-Lapse Recording Counter
“Recording at Intervals (TIME-LAPSE RECORDING)” (☞ p. 111)
- 11** Remaining Recording Time
“Checking the Remaining Recording Time” (☞ p. 117)
- 12** Scene Counter
- 13** MIC LEVEL
“MIC LEVEL” (☞ p. 181)

Still Image Recording

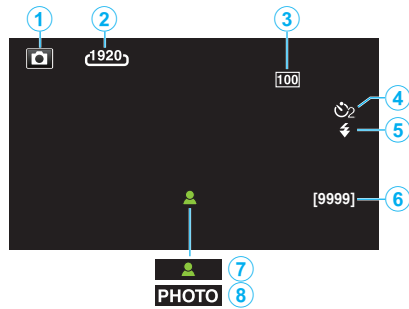

- 1 Still Image Mode
“ (Video/Still Image) Button” (☞ p. 208)
- 2 Image Size
“IMAGE SIZE” (☞ p. 190)
- 3 GAIN
“GAIN” (☞ p. 187)
- 4 Self-Timer
“Taking Group Shots (Self-timer)” (☞ p. 114)
- 5 Flash
“FLASH” (☞ p. 186)
- 6 Remaining Number of Shots
“Checking the Remaining Recording Time” (☞ p. 118)
- 7 Focus
- 8 Recording in Progress

Video Playback

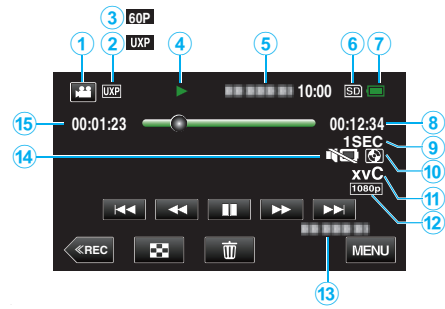

- 1 Video Mode
“ (Video/Still Image) Button” (☞ p. 208)
- 2 Video Quality
“VIDEO QUALITY” (☞ p. 179)
- 3 Progressive Recording
“SYSTEM SELECT” (☞ p. 179)
- 4 Operation Indicator
“Operation Buttons for Video Playback” (☞ p. 119)
- 5 Date/Time
 - Displays the recording date and time.
- 6 Media
- 7 Battery Indicator
“Checking the Remaining Recording Time” (☞ p. 117)
- 8 Playback Time
“Playing Back Videos” (☞ p. 119)
- 9 Time-Lapse Playback
“Time-Lapse Setting” (☞ p. 112)
- 10 External Storage Playback
 - “Playing Back with a DVD Writer” (☞ p. 145)
 - “Playing Back with a BD Writer (External Blu-ray Drive)” (☞ p. 153)
 - “Playing Back Files in the USB External Hard Disk Drive” (☞ p. 157)
- 11 x.v.Color
“x.v.Color” (☞ p. 180)
- 12 1080p Output
“HDMI OUTPUT” (☞ p. 204)
- 13 Recording Date/Time
“Recording Videos with Date and Time” (☞ p. 116)
- 14 SILENT MODE
“SILENT MODE” (☞ p. 199)
- 15 Scene Counter

Still Image Playback

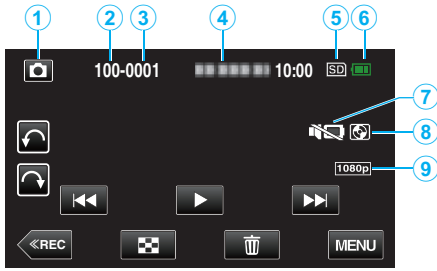

- 1 Still Image Mode
“ (Video/Still Image) Button” (p. 208)
- 2 Folder Number
- 3 File Number
- 4 Date/Time
 - Displays the recording date and time.
- 5 Media
- 6 Battery Indicator
“Checking the Remaining Recording Time” (p. 117)
- 7 SILENT MODE
“SILENT MODE” (p. 199)
- 8 External Storage Playback
“Playing Back with a DVD Writer” (p. 145)
“Playing Back with a BD Writer (External Blu-ray Drive)” (p. 153)
“Playing Back Files in the USB External Hard Disk Drive” (p. 157)
- 9 1080p Output
“HDMI OUTPUT” (p. 204)

When the unit is not working properly

Turning Off the Power

- 1 Close the LCD monitor.

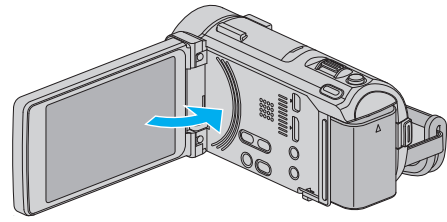

- 2 Remove the AC adapter and battery pack from this unit, reattach them, open the LCD monitor and this unit powers on automatically. (Reset complete)

Battery Pack

Unable to turn on the power when using the battery pack.

Recharge the battery pack.

“Charging the Battery Pack” (☞ p. 64)

Check whether the terminals are dirty.

If the terminal of this unit or the battery pack is dirty, wipe it with a cotton swab or something similar.

If you use any other battery packs besides JVC battery packs, safety and performance cannot be guaranteed. Be sure to use JVC battery packs.

Short usage time even after charging.

Battery deterioration occurs when a battery pack is charged repeatedly.

Replace the battery pack with a new one.

“Optional Accessories” (☞ p. 75)

Unable to charge the battery pack.

When the battery pack is fully charged, the lamp does not flash.

Check whether the terminals are dirty.

If the terminal of this unit or the battery pack is dirty, wipe it with a cotton swab or something similar.

Using a non-original AC adapter may result in damage to this unit. Be sure to use an original AC adapter.

The remaining battery display is not correct.



Remaining battery power is not displayed when the AC adapter is connected.

If this unit is used for long periods of time in high or low temperatures, or if the battery pack is repeatedly charged, the amount of remaining battery may not be displayed correctly.

Recording

Recording cannot be performed.

Check the  button.

“ /  (Video/Still Image) Button” (☞ p. 208)

When there are multiple light sources and depending on the shooting conditions, exposure and focus may not be adjusted correctly in the Intelligent Auto mode. In this case, adjust the settings manually.

“Adjusting Focus Manually” (☞ p. 86)

Recording stops automatically.

Recording stops automatically as it cannot be performed for 12 or more consecutive hours according to specifications. (It may take some time to resume recording.)

Turn off this unit, wait for a while, and turn it on again. (This unit stops automatically to protect the circuit when the temperature rises.)

The continuous shooting speed of still images is slow.

The continuous shooting speed will drop if this function is used repeatedly. Continuous shooting speed may drop depending on the SD card or under certain recording conditions.

The focus is not adjusted automatically.

If you are recording in a dark place or a subject that has no contrast between dark and light, adjust the focus manually.

“Adjusting Focus Manually” (☞ p. 86)

Wipe the lens with a lens cleaning cloth.

Cancel manual focus on the manual recording menu.

“Adjusting Focus Manually” (☞ p. 86)

Zoom does not work.

Digital zoom is not available in the still image recording mode.

Zoom operation is not available in time-lapse recording. (Simultaneous still image recording and image stabilizer are also not available.)

To use digital zoom, set “ZOOM” in the menu accordingly.

“ZOOM” (☞ p. 180)

Mosaic-type noise occurs when recording scenes with fast movements or extreme changes in brightness.

Set the “VIDEO QUALITY” to “UXP” or “XP” for recording.

“VIDEO QUALITY” (☞ p. 179)

Vertical lines appear on recorded images.

Such a phenomenon occurs when shooting a subject illuminated by bright light. This is not a malfunction.

A rattling sound is heard when turning on the power.

A sound is output when the image stabilizer starts.

This is not a malfunction.

Card

Cannot insert the SD card.

Make sure not to insert the SD card in the wrong direction.
“Inserting an SD Card” (☞ p. 65)

Unable to copy to SD card.

To use SD cards that have been used on other devices, it is necessary to format (initialize) the SD card using “FORMAT SD CARD” from media settings.
“FORMAT SD CARD” (☞ p. 205)

Playback

Sound or video is interrupted.

Sometimes playback is interrupted at the connecting section between two scenes. This is not a malfunction.

There is no sound.

When the Silent mode is used, operation and playback sounds will not be output. Turn off the Silent mode.
“SILENT MODE” (☞ p. 199)
Set “OPERATION SOUND” in the common menu to “ON”.
“OPERATION SOUND” (☞ p. 199)
Audio sound is not recorded for videos taken in HIGH SPEED RECORDING/TIME-LAPSE RECORDING.
“Slow-motion (High-speed) Recording” (☞ p. 110)
“Recording at Intervals (TIME-LAPSE RECORDING)” (☞ p. 111)

The same image is displayed for a long time.

Use a high speed SD card (Class 4 or higher).
“Types of Usable SD Card” (☞ p. 66)
Clean the terminals of the SD card with a dry cotton swab or something similar.
Execute “FORMAT SD CARD” in the “COMMON” menu. (All data will be deleted.)
“FORMAT SD CARD” (☞ p. 205)

The motion is choppy.

Use a high speed SD card (Class 4 or higher).
“Types of Usable SD Card” (☞ p. 66)
Clean the terminals of the SD card with a dry cotton swab or something similar.
Execute “FORMAT SD CARD” in the “COMMON” menu. (All data will be deleted.)
“FORMAT SD CARD” (☞ p. 205)
Verify the system requirements of your computer when using Everio MediaBrowser to play back.
“Verifying System Requirements (Guideline)” (☞ p. 160)

Cannot find a recorded file.

Cancel the date search function.
“Searching for a Specific Video/Still Image by Date” (☞ p. 125)
Select “PLAYBACK OTHER FILE” in the menu. (Video files that have damaged management information can be played back.)
“Playing a Video with Defective Management Information” (☞ p. 122)
Images recorded in 60p mode and 60i mode are displayed on the index screen separately. To view videos recorded in the 60p mode or 60i mode, set “SYSTEM SELECT” to “60p” or “60i” respectively, followed by setting to the playback mode.
“SYSTEM SELECT” (☞ p. 179)

Images do not appear on the TV properly.

Disconnect the cable and connect again.
“Connecting via the HDMI Mini Connector” (☞ p. 126)
Turn off and on this unit again.

Images are projected vertically on the TV.

Set “VIDEO OUTPUT” in the “COMMON” menu to “4:3”.
“VIDEO OUTPUT” (☞ p. 203)
Adjust the TV's screen accordingly.

The image displayed on TV is too small.

Set “VIDEO OUTPUT” in the “COMMON” menu to “16:9”.
“VIDEO OUTPUT” (☞ p. 203)

When connected to the TV via the HDMI mini cable, proper images and sounds are not output.

Images and sounds may not be output properly depending on the TV connected. In such cases, perform the following operations.
① Disconnect the HDMI mini cable and connect it again.

- ② Turn off and on this unit again.
 “Connecting via the HDMI Mini Connector” (☞ p. 126)

Editing/Copying

Unable to delete file.

Files (videos/still images) that are protected cannot be deleted. Release protection before deleting the file.
 “Protecting Files” (☞ p. 130)

Unable to create DVD with a DVD writer.

The USB cable is not connected correctly.
 “Preparing a DVD Writer (CU-VD50)” (☞ p. 140)
 “Preparing a DVD Writer (CU-VD3)” (☞ p. 140)

Unable to create disc with a BD writer (external Blu-ray drive).

The USB cable is not connected correctly.
 “Preparing a BD Writer (External Blu-ray Drive)” (☞ p. 146)

BACK-UP menu does not disappear.

While the USB cable is connected, the “BACK UP” menu is displayed.

Unable to turn off the BACK-UP menu.

Turn off the power of this unit and the DVD writer, or remove the AC adapter.

Unable to delete folder in USB external hard disk drive.

Delete the folder using a computer.
 (When files are added or folders moved/renamed with a computer, they cannot be deleted on this unit.)

Computer

Unable to copy files to the computer's HDD.

Connect the USB cable correctly.

"Backing Up All Files" (☞ p. 162)

If the provided software Everio MediaBrowser 4 BE is not installed, some functions may not work properly.

"Installing the Provided Software" (☞ p. 161)

Before making backup, make sure that enough free space is left in the computer's hard disk (HDD).

Unable to copy files to DVD or Blu-ray disc with a PC.

To record to discs, a recordable DVD or Blu-ray drive is required for the computer in use.

Cannot upload the file to YouTube.

Check if you have created an account with YouTube. (You need a YouTube account to upload files to YouTube.)

Changing videos to the file format for uploading cannot be performed on this unit.

Refer to "Q&A", "Latest Information", "Download Information", etc. in "Click for Latest Product Info" in the help file of the provided software Everio MediaBrowser 4 BE.

I am using a Mac computer.

Copy the files to a Mac computer using the following method.

"Copying to Mac Computer" (☞ p. 168)

The computer cannot recognize the SDXC card.

Confirm and update the OS of your computer.

"When your computer cannot recognize the SDXC card" (☞ p. 66)

Screen/Image

The LCD monitor is difficult to see.

The LCD monitor may be difficult to see if used in bright areas such as under direct sunlight.

A band or a ball of bright light appears on the LCD monitor.

Change the direction of this unit to prevent the light source from coming into view. (A band or a ball of bright light may appear when there is a bright light source near this unit, but this is not a malfunction.)

The recorded subject is too dark.

Use backlight compensation when the background is bright and the subject is dark.

"Setting Backlight Compensation" (☞ p. 91)

Use "LIGHT" in the menu.

"LIGHT" (☞ p. 175)

Use "NIGHTALIVE" in SCENE SELECT.

"Shooting According to Scene (Subject)" (☞ p. 84)

Use "GAIN UP" in the menu.

"GAIN UP" (☞ p. 175)

Set "BRIGHTNESS ADJUST" in the recording menu to the "+" side.

"Adjusting Brightness" (☞ p. 87)

Decrease the shutter speed. (Subject may be blurred if the shutter speed is too slow.)

"Setting Shutter Speed" (☞ p. 88)

Set to a smaller aperture value.

"Setting Aperture" (☞ p. 89)

The recorded subject is too bright.

Set the backlight compensation to "OFF" if it is being used.

"Setting Backlight Compensation" (☞ p. 91)

Set "BRIGHTNESS ADJUST" in the recording menu to the "-" side.

"Adjusting Brightness" (☞ p. 87)

Increase the shutter speed.

"Setting Shutter Speed" (☞ p. 88)

Set to a larger aperture value.

"Setting Aperture" (☞ p. 89)

The color looks strange. (Too bluish, too reddish, etc.)

Wait for a while until natural colors are achieved. (It may take some time for white balance to be adjusted.)

Set "WHITE BALANCE" in the recording menu to "MANUAL". Select from "FINE"/"CLOUD"/"HALOGEN"/"MARINE:BLUE"/"MARINE:GREEN"

according to the light source.

Select "MWB" and adjust accordingly.

"Setting White Balance" (☞ p. 90)

The color looks different.

Set "WHITE BALANCE" in the recording menu accordingly.

"Setting White Balance" (☞ p. 90)

When the video was recorded with "x.v.Color" set to "ON", change the setting as desired on TV.

"x.v.Color" (☞ p. 180)

There are bright or dark spots on the screen.

While the LCD monitor screen has more than 99.99% effective pixels, 0.01% of the pixels may be bright spots (red, blue, green) or dark spots. This is not a malfunction. The spots will not be recorded.

Other Problems

The buttons on the touch screen do not work.

Tap the buttons on the touch screen with your fingers or the stylus pen. The buttons may not respond if you touch them with your fingernails or with gloves on.

The image is grainy.

When digital zoom is used, the image becomes grainy as it is digitally enlarged.

This unit heats up.

This is not a malfunction. (This unit may become warm when used for a long time.) Stop using the unit if it gets too warm.

The language on the display changed.

It may occur when you connect this unit to a TV with different language setting using an HDMI mini cable.

“Operating in Conjunction with TV via HDMI” (☞ p. 126)

When connected to the TV via the HDMI mini cable, proper images and sounds are not output.

Images and sounds may not be output properly depending on the TV connected. In such cases, perform the following operations.

- ① Disconnect the HDMI mini cable and connect it again.
- ② Turn off and on this unit again.

“Connecting via the HDMI Mini Connector” (☞ p. 126)

HDMI-CEC functions do not work properly, and the TV does not work in conjunction with this unit.

TVs may operate differently depending on the specifications, even if they are HDMI-CEC compliant. Therefore, the HDMI-CEC functions of this unit cannot be guaranteed to operate in combination with all the TVs.

In such cases, set “HDMI CONTROL” to “OFF”.

“HDMI CONTROL” (☞ p. 204)

The unit operates slowly when switching between video mode and still image mode, or when switching the power on or off.

It is recommended that you copy all videos and still images onto your computer, and erase the files from this unit. (If there are many recorded files on this unit, it takes time for the unit to respond.)

The remote control does not work.

Replace the battery of the remote control.

“Reinserting the Battery” (☞ p. 71)

Set “REMOTE” in the “COMMON” menu to “ON”.

“REMOTE” (☞ p. 201)

The remote control may not operate outdoors or in places exposed to strong light.

This unit does not function properly and error messages appear.

This unit is a microcomputer-controlled device. Electrostatic discharge, external noise and interference (from a TV, a radio, etc.) might prevent it from functioning properly. In such a case, turn off the power, then remove the AC adapter and battery pack. This unit will be reset.

Make a backup of important recorded data.

Make a backup of important recorded data.

- It is recommended to copy your important recorded data to a DVD or other recording media for storage.
- JVC will not be responsible for any lost data.

Error Message?

SET DATE/TIME!

Connect the AC adapter, charge the battery for more than 24 hours and set the clock. (If the message still appears, the clock battery is exhausted.

Consult your nearest JVC dealer.)

“Clock Setting” (☞ p. 69)

COMMUNICATION ERROR

Reconnect the USB cable.

Turn off this unit and the devices connected to it, and turn them on again.

Reattach the battery pack.

MEMORY CARD ERROR!

Check that the card is supported by this unit.

“Types of Usable SD Card” (☞ p. 66)

Turn off and on this unit again.

Remove the AC adapter and battery pack, then remove and re-insert the SD card.

Remove any dirt from the SD card terminals.

If the above does not solve the problem, back up your files and execute

“FORMAT SD CARD” in the “COMMON” menu. (All data will be deleted.)

“FORMAT SD CARD” (☞ p. 205)

NOT FORMATTED

Select “OK”, then select “YES” on the “DO YOU WANT TO FORMAT?” screen.

RECORDING FAILURE

Turn off and on this unit again.

CANNOT TAKE MORE STILL IMAGES AT THIS TIME

Stop video recording before taking still images. (If the SD card is removed and inserted during video recording, still images cannot be recorded.)

PLAYBACK FAILED

Remove and re-insert the SD card.

“Inserting an SD Card” (☞ p. 65)

Remove any dirt from the SD card terminals.

Insert the SD card before turning on the power.

Do not subject this unit to any strong impact or vibration.

VIDEO MANAGEMENT FILE IS DAMAGED, RECOVERY IS REQUIRED TO RECORD/PLAYBACK, RECOVER?

Select “OK” to restore. (Videos that cannot be restored will not be displayed on the index screen, but you may be able to play them back using “PLAYBACK OTHER FILE” in the menu.)

“Playing a Video with Defective Management Information” (☞ p. 122)

UNSUPPORTED SCENE!

Use files recorded with this unit. (Files recorded with other devices may not be playable.)

UNSUPPORTED FILE!

Use files recorded with this unit. (Files recorded with other devices may not be playable.)

THIS FILE IS PROTECTED

Switch off the “PROTECT/CANCEL” function in the “EDIT” menu.

“Protecting Files” (☞ p. 130)

CHECK CARD'S WRITE PROTECTION SWITCH

Set the write protect switch of the SD card to off.

INSUFFICIENT AVAILABLE SPACE

Delete files, or move files to a computer or other devices.

Troubleshooting

Replace the SD card with a new one.

RECORDABLE MANAGEMENT CAPACITY LEVEL HAS BEEN REACHED

- ① Move the files or folders to a computer or other device. (Back up your files.)
- ② Select “FILE + MANAGEMENT NO” in “FORMAT SD CARD” of the media settings menu. (All data on the SD card will be deleted.)
“FORMAT SD CARD” (☞ p. 205)

SCENE QUANTITY EXCEEDED LIMIT

- ① Move the files or folders to a computer or other device. (Back up your files.)
- ② Select “FILE + MANAGEMENT NO” in “FORMAT SD CARD” of the media settings menu. (All data on the SD card will be deleted.)
“FORMAT SD CARD” (☞ p. 205)

NUMBER OF FOLDERS OVERFLOW

- ① Move the files or folders to a computer or other device. (Back up your files.)
- ② Select “FILE + MANAGEMENT NO” in “FORMAT SD CARD” of the media settings menu. (All data on the SD card will be deleted.)
“FORMAT SD CARD” (☞ p. 205)

FILE QUANTITY LIMIT EXCEEDED

- ① Move the files or folders to a computer or other device. (Back up your files.)
- ② Select “FILE + MANAGEMENT NO” in “FORMAT SD CARD” of the media settings menu. (All data on the SD card will be deleted.)
“FORMAT SD CARD” (☞ p. 205)

PLAYLIST QUANTITY EXCEEDS LIMIT

Reduce the number of the playlist to 99 files or less. (Up to 99 playlists can be created.)

CANCELLED BECAUSE PLAYLIST AMOUNT EXCEEDED MAXIMUM LIMIT

When creating a DVD, reduce the number of playlists to be saved.
Reduce the number of videos to add to the playlist to 999 files.
“Creating Playlists from the Recorded Videos” (☞ p. 135)

PROCESSING CANCELLED DUE TO LIMITED SPACE FOR OPERATION

Reduce the number of videos to add to the playlist to 999 files.
“Creating Playlists from the Recorded Videos” (☞ p. 135)

RECORDING CANCELLED

Turn off and on this unit again.
Protect the unit from vibration and shock.

CAMERA TEMPERATURE IS HIGH PLEASE TURN CAMERA OFF TO ALLOW IT TO COOL DOWN PLEASE WAIT

Turn off the power of this unit, let and it cool down before turning on the power again.

CAMERA TEMPERATURE IS TOO HIGH, POWER WILL TURN OFF TO PROTECT THE CAMERA

The power may turn off to protect the circuit if the temperature of this unit rises too much.
If the temperature of this unit rises during recording, ● **REC** changes color to yellow as a notification.

POWER IS OFF, OR USB DEVICE IS UNSUPPORTED

Turn on the power of the connected USB device.
Connect the AC adapter to the DVD writer or BD writer (external Blu-ray drive).

INSERT DISC

Open the tray of the DVD writer or BD writer (external Blu-ray drive), check and reset the DVD or Blu-ray disc, then close the tray.
Replace the disc in the DVD writer or BD writer (external Blu-ray drive).

CHANGE DISC

Open the tray of the DVD writer or BD writer (external Blu-ray drive), check and reset the DVD or Blu-ray disc, then close the tray.
Replace the disc in the DVD writer or BD writer (external Blu-ray drive).

Perform regular maintenance of this unit to enable it to be used for a long time.

Caution :

- Be sure to detach the battery pack, AC adapter, and power plug before performing any maintenance.

Camcorder

- Wipe this unit with a dry, soft cloth to remove any dirt.
- When it is extremely dirty, soak the cloth in a solution of neutral detergent, wipe the body with it, and then use a clean cloth to remove the detergent.

Caution :

- Do not use solvents such as benzene, thinner, or alcohol. Doing so may cause damage to the unit.
- When using a chemical cloth or cleaner, be sure to observe the warning labels and instructions of the product.
- Do not leave the device in contact with rubber or plastic products for a long time.

Lens/LCD Monitor

- Use a lens blower (commercially available) to remove any dust, and a cleaning cloth (commercially available) to wipe off any dirt.
Mold may form if the lens is left dirty.
- You can use a commercially available anti-reflection or protective film on the screen.
However, depending on the thickness of the film, operations on the touch screen may not be performed smoothly or the screen may darken slightly.

Camera

Item	Details
Power supply	Using AC adapter: DC 5.2 V Using battery pack: DC 3.6 V
Power consumption	3.7 W (60i mode, "LIGHT": "OFF", MONITOR BRIGHTNESS: 3 (standard)) 4.3 W (60i mode, "LIGHT": "OFF", MONITOR BRIGHTNESS: 4 (brighter)) 4.1 W (60p mode, "LIGHT": "OFF", MONITOR BRIGHTNESS: 3 (standard)) 4.7 W (60p mode, "LIGHT": "OFF", MONITOR BRIGHTNESS: 4 (brighter))
Dimensions (mm)	57 x 63 x 129 (2-1/4" x 2-1/2" x 5-1/8") (W x H x D: excluding grip belt)
Mass	Approx. 360 g (0.8 lbs) (camera only), Approx. 400 g (0.89 lbs) (including supplied battery pack)
Operating environment	Allowable operating temperature: 0°C to 40°C (32°F to 104°F) Allowable storage temperature: -20°C to 50°C (-4°F to 122°F) Allowable relative humidity: 35 % to 80 %
Image pickup device	1/2.3" 10,620,000 pixels (BSI CMOS)
Recording area (Video)	2,070,000 to 4,770,000 pixels (Ⓜ): OFF, dynamic zoom: ON)
Recording area (Still image)	3,980,000 to 5,290,000 pixels (4:3) (Ⓜ): OFF) 2,990,000 to 3,970,000 pixels (16:9) (Ⓜ): OFF)
Lens	F1.2 - 2.8, f= 3.76 mm to 37.6 mm Video 35 mm conversion *1: 29.5 mm to 448 mm (dynamic zoom: ON) 35 mm conversion *1: 29.5 mm to 406 mm (dynamic zoom: OFF) Still Image 35 mm conversion: 29.7 mm to 297 mm (4:3) 35 mm conversion: 32.4 mm to 324 mm (16:9)

Item	Details
Lowest illumination	10 lux (GAIN UP: ON) 2 lux (GAIN UP: AUTO SLOW-SHUTTER) 1 lux (SCENE SELECT: NIGHTALIVE)
Flash	Recommended shooting distance: Within 2 m
Filter diameter *2	46 mm (screw pitch: 0.75 mm)
Zoom (during video recording)	Optical zoom: Up to 10x Dynamic zoom: Up to 15x (Ⓜ): OFF), Up to 13x (Ⓜ): ON), Up to 12x (Ⓜ): ON (AIS)), Up to 10x (Ⓜ): ON (enhanced AIS)) Digital zoom: Up to 200x
Zoom (during still image recording)	Optical zoom: Up to 10x
Continuous shooting speed (during video record-standby)	HIGH SPEED: Approx. 60 images/second MEDIUM SPEED: Approx. 10 images/second LOW SPEED: Approx. 1.5 images/second (Maximum)
Continuous shooting speed (during still image recording)	HIGH SPEED: Approx. 15 images/second MEDIUM SPEED: Approx. 7.5 images/second LOW SPEED: Approx. 2 images/second (Maximum)
LCD monitor	3.5", 920,000 pixels, polysilicon color LCD
Recording media	SD/SDHC/SDXC card (commercially available) "Types of Usable SD Card" (Ⓜ p. 66)
Clock battery	Rechargeable battery

*1 Calculated when image stabilizer is set to "OFF" on the wide (W) end and "ON (AIS)" on the tele (T) end.

*2

- When a lens filter or conversion lens is attached, the flash cannot be used. Set "FLASH" in the menu to "OFF".
 - When a tele conversion lens is attached, the remote control cannot be used as the sensor will be covered.
- In addition, white balance may not function properly. Set "WHITE BALANCE" in the Manual mode accordingly.
- Wide conversion lens cannot be attached.

Connectors

Item	Details
HDMI output connector	HDMI Mini Connector (x.v.Color compatible)
AV output connector	Video output: 1.0 V (p-p), 75 Ω Audio output: 300 mV (rms), 220 Ω
USB connector	Mini USB Type AB, USB 2.0 compliant

Video

Item	Details
Recording/ Playback format	AVCHD standard Ver 2.0 (AVCHD Progressive) Video: MPEG-4 AVC/H.264 Audio: Dolby Digital 2ch
Extension	.MTS
Signal system	NTSC standard
Image quality (Video)	60p 1920 x 1080 pixels Maximum Approximate 28 Mbps UXP 1920 x 1080 pixels Average Approximate 24 Mbps XP 1920 x 1080 pixels Average Approximate 17 Mbps SP 1920 x 1080 pixels Average Approximate 12 Mbps EP 1920 x 1080 pixels Average Approximate 4.8 Mbps
Sound quality (Audio)	48 kHz, 256 kbps

Still Image

Item	Details
Recording format	JPEG standard
Extension	.JPG
Image size	"Approximate Number of Still Images (Unit: Number of Shots)" (see p. 118)

AC Adapter (AP-V30U)

Item	Details
Power supply	AC 110 V to 240 V, 50 Hz/60 Hz
Output	DC 5.2 V, 1.8 A
Allowable operating temperature	0°C to 40°C (32°F to 104°F) (10°C to 35°C (50°F to 95°F) during charging)
Dimensions (mm)	78 x 34 x 46 (3-1/8" x 1-3/8" x 1-13/16") (W x H x D: excluding cord and AC plug)
Mass	Approx. 107 g (0.24 lbs)

Battery Pack (BN-VG114U)

Item	Details
Power voltage	3.6 V
Capacity	1400 mAh
Dimensions (mm)	31 mm x 21.5 mm x 43 mm (1-1/4" x 7/8" x 1-3/4") (W x H x D)
Mass	Approx. 40 g (0.09 lbs)

Remote Control (RM-V760U)

Item	Details
Power supply	DC 3 V (button battery CR2025)
Battery life	Approx. 1 year (depending on frequency of use)
Operating distance	Approx. 5 m (facing up)
Allowable operating temperature	0°C to 40°C (32°F to 104°F)
Dimensions (mm)	32.5 x 15.6 x 68 (1-5/16" x 5/8" x 2-11/16") (W x H x D)
Mass	Approx. 16 g (0.04 lbs) (including battery pack)

Memo :

- The specifications and appearance of this product are subject to changes for further improvement without prior notice.

JVC